



W
I
R
K
K
A
L
A

Disegnata da Tapio Wirkkala per Airam nel 1959, la lampada WIR fu una novità nel design delle lampade. A questa lampada elegante con il suo vetro opale e il suo portalam-pada semplificato venne assegnato il premio Grand Prix alla XII Triennale di Milano nel 1960. La lampada divenne immediatamente un successo internazionale.

Più avanti Wirkkala progettò una gamma completa di apparecchi di illuminazione: una serie di lampade in vetro colorato che potessero non solo esaltare la luce piacevole e la forma della lampadina, ma anche aggiungere varietà alla loro semplice eleganza.



12'
Triennale
di Milano

diploma di gran premio

WIRKKALA K2-142 LAMPADA A SOSPENSIONE LED DIMMERABILE

AGGIORNATO



IT

- Lampada a sospensione in vetro disegnata da Tapio Wirkkala, premiato per il design della lampada WIR alla XII triennale di Milano (1960)
- Monta una lampada WIR-85 dimmerabile con attacco E27 (inclusa)
- Disponibile con vetro in 4 colorazioni
- Compatibile con CEILING CUP e CEILING BAR per composizione di tre o quattro elementi

EN

- Glass pendant light designed by Tapio Wirkkala, awarded for the design of the WIR bulb at the XII Triennale exhibition of Milan (1960)
- Requires a dimmable WIR-85 bulb with E27 base (included)
- Glass shade available in 4 colours
- Compatible with CEILING CUP and CEILING BAR for three or four-light cluster

POTENZA WATT	BASE	KELVIN	LUMEN LM	FASCIO °	MISURE MM	VARIANTE	CODICE	EAN	IMBALLO	PREZZO €
8	E27	3000	760	360	1	SMOKED BLUE	4126206	6435200234636	1/4	-
8	E27	3000	760	360	1	GREENISH GREY	4126207	6435200234650	1/4	-
8	E27	3000	760	360	1	SAND	4126208	6435200234674	1/4	-
8	E27	3000	760	360	1	CLEAR	4126268	6435200247087	1/4	-

NEW

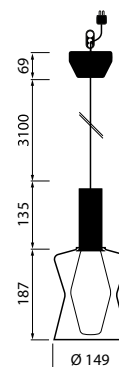
IT

- Lampada a sospensione in vetro disegnata da Tapio Wirkkala, premiata per il design della lampada WIR alla XII triennale di Milano (1960)
- Monta una lampada WIR-85 dimmerabile con attacco E27 (inclusa)
- Disponibile con vetro in 4 colorazioni
- Compatibile con CEILING CUP e CEILING BAR per composizione di tre o quattro elementi

EN

- Glass pendant light designed by Tapio Wirkkala, awarded for the design of the WIR bulb at the XII Triennale exhibition of Milan (1960)
- Requires a dimmable WIR-85 bulb with E27 base (included)
- Glass shade available in 4 colours
- Compatible with CEILING CUP and CEILING BAR for three or four-light cluster



POTENZA WATT	BASE	KELVIN	LUMEN LM	FASCIO °	MISURE MM	VARIANTE	CODICE	EAN	IMBALLO	PREZZO €
8	E27	3000	760	360	1	SMOKED BLUE	4126209	6435200234698	1/4	-
8	E27	3000	760	360	1	GREENISH GREY	4126210	6435200234711	1/4	-
8	E27	3000	760	360	1	SAND	4126211	6435200234735	1/4	-
8	E27	3000	760	360	1	CLEAR	4126267	6435200247063	1/4	-

NEW

WIRKKALA K2-140 LAMPADA A SOSPENSIONE LED DIMMERABILE

NEW



IT

- Lampada a sospensione con corpo in acciaio satinato disegnata da Tapio Wirkkala.
- Cavo di alimentazione traslucido e paralume in vetro trasparente.
- Monta una lampadina WIR-105 dimmerabile con attacco E27 (inclusa)
- Compatibile con CEILING CUP e CEILING BAR per composizione di tre o quattro elementi

EN

- Brushed stainless steel pendant designed by Tapio Wirkkala
- Clear glass shade and translucent power cord
- Requires a dimmable WIR-105 bulb with E27 base (included)
- Compatible with CEILING CUP and CEILING BAR for three or four-light cluster



IP20
220v 240v
15.000 H
INSTANT
DIMMABLE

POTENZA WATT	BASE	KELVIN	LUMEN LM	FASCIO °	MISURE MM	VARIANTE	CODICE	EAN	IMBALLO	PREZZO €
6	E27	3000	470	360	1	CLEAR	4126269	6435200247100	1/4	-



WIR LAMPPU K2-131 LAMPADA A SOSPENSIONE LED **DIMMERABILE**



IT

- Lampada a sospensione con corpo nero disegnata da Tapio Wirkkala nel 1959 e premiata alla XII Triennale di Milano nel 1960.
- Monta una lampadina WIR-85 dimmerabile con attacco E27 (inclusa)
- Compatibile con CEILING CUP e CEILING BAR per composizione di tre o quattro elementi

EN

- Pendant light with black body designed by Tapio Wirkkala in 1959, awarded for the design at the XII Triennale exhibition of Milan in 1960
- Requires a dimmable WIR-85 bulb with E27 base (included)
- Compatible with CEILING CUP and CEILING BAR for three or four-light cluster

POTENZA WATT	BASE	KELVIN	LUMEN LM	FASCIO °	MISURE MM	VARIANTE	CODICE	EAN	IMBALLO	PREZZO €
8	E27	3000	760	360	1	-	4126212	6435200234759	1/6	-

WIR LAMPPU K2-80 KRS LAMPADA A SOSPENSIONE LED DIMMERABILE

NEW

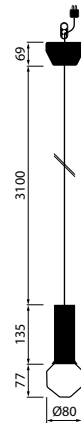

IT

- Lampada a sospensione con corpo in acciaio satinato disegnata da Tapio Wirkkala nel 1968.
- Monta una lampadina WIR-80 KRS dimmerabile con attacco E27 (inclusa)
- Compatibile con CEILING CUP e CEILING BAR per composizione di tre o quattro elementi

EN

- Brushed stainless steel pendant designed by Tapio Wirkkala in 1968
- Requires a dimmable WIR-80 KRS bulb with E27 base (included)
- Compatible with CEILING CUP and CEILING BAR for three or four-light cluster



POTENZA WATT	BASE	KELVIN	LUMEN LM	FASCIO °	MISURE MM	VARIANTE	CODICE	EAN	IMBALLO	PREZZO €
3,5	E27	2500	280	360	1	-	4126270	6435200247124	1/6	-



WIR LAMPPU K2-105 LAMPADA A SOSPENSIONE LED DIMMERABILE

NEW



IT

- Lampada a sospensione con corpo nero disegnata da Tapio Wirkkala
- Monta una lampadina WIR-105 dimmerabile con attacco E27 (inclusa)
- Compatibile con CEILING CUP e CEILING BAR per composizione di tre o quattro elementi

EN

- Pendant light with black body designed by Tapio Wirkkala
- Requires a dimmable WIR-105 bulb with E27 base (included)
- Compatible with CEILING CUP and CEILING BAR for three or four-light cluster

IP20
 220v 240v
15.000 H
INSTANT
 DIMMABLE

POTENZA WATT	BASE	KELVIN	LUMEN LM	FASCIO °	MISURE MM	VARIANTE	CODICE	EAN	IMBALLO	PREZZO €
6	E27	3000	470	360	1	-	4126271	6435200247148	1/6	-

LAMPADA A LED WIR-85 DIMMERABILE

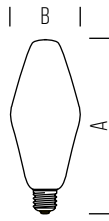

DIMENSIONI	A	B
1	206	85



15.000 H



POTENZA WATT	BASE	KELVIN	LUMEN LM	FASCIO °	MISURE MM	VARIANTE	CODICE	EAN	IMBALLO	PREZZO €
8	E27	3000	760	360	1	-	4711789	6435200231840	1	-

LAMPADA A LED WIR-105 DIMMERABILE

NEW

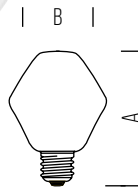

DIMENSIONI	A	B
1	143	105



15.000 H



POTENZA WATT	BASE	KELVIN	LUMEN LM	FASCIO °	MISURE MM	VARIANTE	CODICE	EAN	IMBALLO	PREZZO €
6	E27	3000	470	360	1	-	406505	6435200179487	1	-

LAMPADA A LED WIR-80 KRS DIMMERABILE

NEW

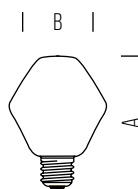

DIMENSIONI	A	B
1	119	80



15.000 H



POTENZA WATT	BASE	KELVIN	LUMEN LM	FASCIO °	MISURE MM	VARIANTE	CODICE	EAN	IMBALLO	PREZZO €
3,5	E27	2500	280	360	1	-	4711766	6435200231109	1	-



CEILING BAR PER LAMPADA WIRKKALA

NEW

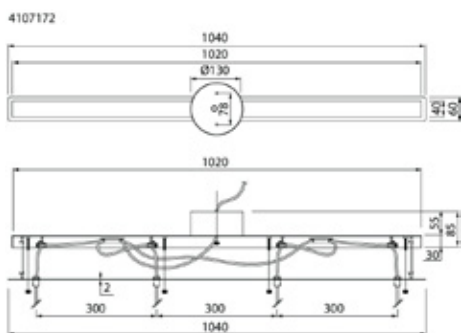
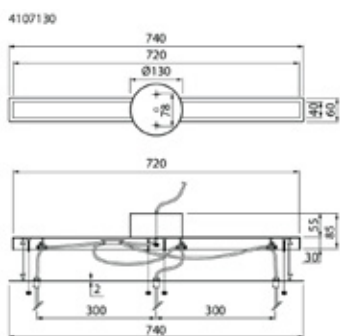

IT

- Corpo in acciaio inossidabile con finitura spazzolata
- Disponibile in due misure: per tre o quattro pendant, distanziati tra loro di 300mm
- Lunghezza del cavo selezionabile per ogni pendant

EN

- Brushed stainless steel body
- Available in two sizes: for three or four pendant spaced 300mm each other
- Selectable cable length for each pendant

POTENZA WATT	BASE	KELVIN	LUMEN LM	FASCIO °	MISURE MM	VARIANTE	CODICE	EAN	IMBALLO	PREZZO €
-	-	-	-	-	1	3 PENDANT	4107130	6435200258595	1/4	-
-	-	-	-	-	2	4 PENDANT	4107172	6435200258618	1/4	-

CEILING CUP PER LAMPADA WIRKKALA

AGGIORNATO

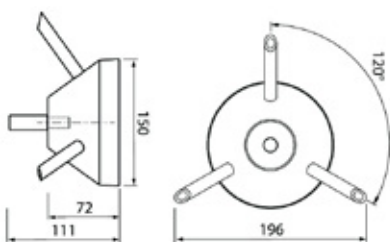
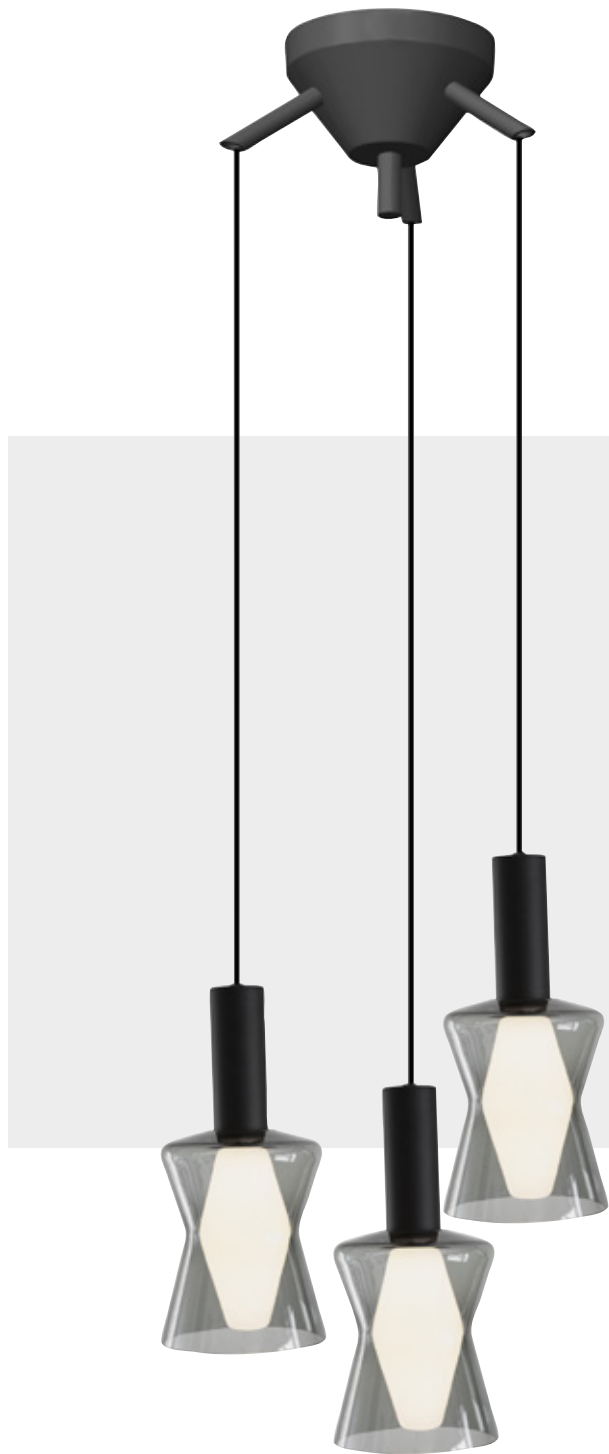
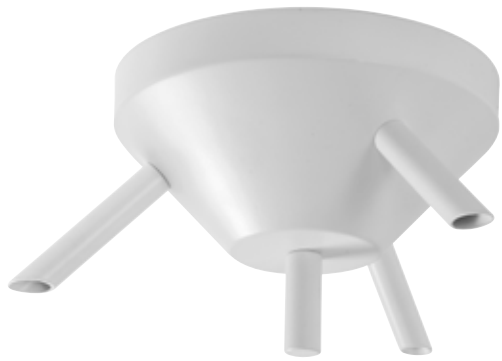

VARIANTE	CODICE	EAN	IMBALLO	PREZZO €
NERO	4126256	6435200241382	1	-
BIANCO	4126276	6435200247568	1	-
ACCIAIO SATINATO	4126277	6435200247582	1	-

NEW

NEW



LAMPADA A SOSPENSIONE GWEN PENDANT

CATEGORIA SCONTO 23

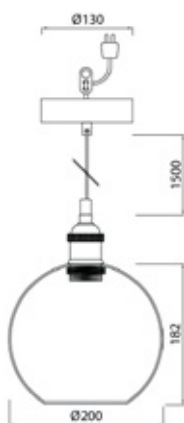

IT

- Incluso cavo rivestito in tessuto nero da 1,5 metri e coppa da soffitto
- Monta una sorgente led con attacco E27 – 40W max. (non inclusa)

EN

- Supplied with 1.5-metre black fabric power cord and ceiling cup
- Requires a LED light source with E27 base – 40W max. (not included)



POTENZA WATT	BASE	KELVIN	LUMEN LM	FASCIO °	MISURE MM	VARIANTE	CODICE	EAN	IMBALLO	PREZZO €
-	E27	-	-	-	1	-	4126247	6435200240798	1/4	59,00

LAMPADA A SOSPENSIONE FAY PENDANT

CATEGORIA SCONTO 23

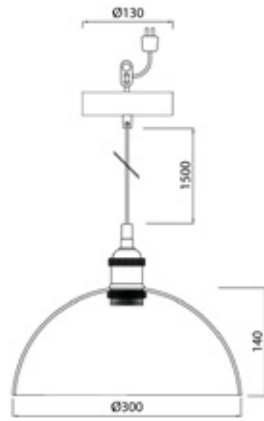

IT

- Incluso cavo rivestito in tessuto nero da 1,5 metri e coppa da soffitto
- Monta una sorgente led con attacco E27 – 40W max. (non inclusa)

EN

- Supplied with 1.5-metre black fabric power cord and ceiling cup
- Requires a LED light source with E27 base – 40W max. (not included)



POTENZA WATT	BASE	KELVIN	LUMEN LM	FASCIO °	MISURE MM	VARIANTE	CODICE	EAN	IMBALLO	PREZZO €
-	E27	-	-	-	1	-	4126248	6435200240811	1/4	77,00



LAMPADA A SOSPENSIONE LIZ PENDANT

CATEGORIA SCONTO 23

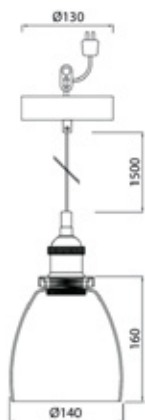

IT

- Incluso cavo rivestito in tessuto nero da 1,5 metri e coppa da soffitto
- Monta una sorgente led con attacco E27 – 40W max. (non inclusa)

EN

- Supplied with 1.5-metre black fabric power cord and ceiling cup
- Requires a LED light source with E27 base – 40W max. (not included)



POTENZA WATT	BASE	KELVIN	LUMEN LM	FASCIO °	MISURE MM	VARIANTE	CODICE	EAN	IMBALLO	PREZZO €
-	E27	-	-	-	1	-	4126249	6435200240835	1/4	44,00

LAMPADA A SOSPENSIONE FLOW PENDANT

CATEGORIA SCONTO 23

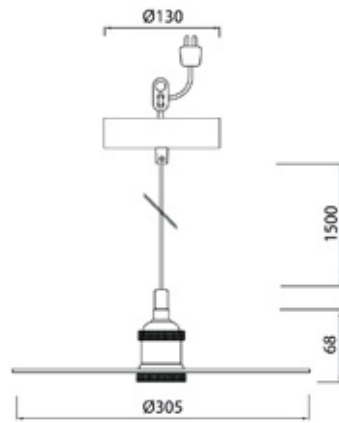

IT

- Incluso cavo rivestito in tessuto nero da 1,5 metri e coppa da soffitto
- Monta una sorgente led con attacco E27 – 40W max. (non inclusa)

EN

- Supplied with 1.5-metre black fabric power cord and ceiling cup
- Requires a LED light source with E27 base – 40W max. (not included)



POTENZA WATT	BASE	KELVIN	LUMEN LM	FASCIO °	MISURE MM	VARIANTE	CODICE	EAN	IMBALLO	PREZZO €
-	E27	-	-	-	1	-	4126250	6435200240859	1/4	80,00



LAMPADA A SOSPENSIONE LOFT35 PENDANT

CATEGORIA SCONTO 23

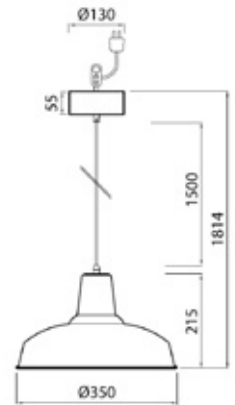

IT

- Incluso cavo da 1,5 metri e coppa da soffitto
- Monta una sorgente led con attacco E27 – 60W max. (non inclusa)

EN

- Supplied with 1.5-metre black fabric power cord and ceiling cup
- Requires a LED light source with E27 base – 60W max. (not included)



POTENZA WATT	BASE	KELVIN	LUMEN LM	FASCIO °	MISURE MM	VARIANTE	CODICE	EAN	IMBALLO	PREZZO €
-	E27	-	-	-	1	BIANCO	9783080	6435200235985	1	53,00
-	E27	-	-	-	1	NERO	9783081	6435200236005	1	53,00



LAMPADA A SOSPENSIONE SANSA PENDANT

CATEGORIA SCONTO 23



IT

- Incluso cavo da 1,5 metri e coppa da soffitto
- Monta una sorgente led con attacco E27 – 40W max. (non inclusa)

EN

- Supplied with 1.5-metre black fabric power cord and ceiling cup
- Requires a LED light source with E27 base – 40W max.
- (not included)



POTENZA WATT	BASE	KELVIN	LUMEN LM	FASCIO °	MISURE MM	VARIANTE	CODICE	EAN	IMBALLO	PREZZO €
-	E27	-	-	-	1	BIANCO	4118754	6435200226525	1/6	50,00
-	E27	-	-	-	1	GRIGIO	4126224	6435200238184	1/6	50,00
-	E27	-	-	-	1	NERO	4126225	6435200238207	1/6	50,00