



NECK

NECK

Apparecchio per illuminazione di esterni costituito da:



- Palo in alluminio estruso verniciato
- Struttura superiore in alluminio pressofuso verniciato
- Diffusore in policarbonato trasparente
- Led ad alta efficienza
- Lenti asimmetriche
- Guarnizione in silicone
- Viti di chiusura in acciaio inox
- Verniciatura in polveri poliestere ad elevata resistenza ai raggi ultravioletti e alla corrosione

Outdoor luminaire constructed of:

- Painted extruded aluminium post
- Painted die-cast aluminium head
- Satin or transparent glass diffuser
- High efficiency led
- Asymmetrical lens
- Silicon gasket
- Stainless steel screws
- Painting using high resistance to UV and corrosion polyester powders



Colori - Colours

- X=3  Nero
Black
- X=9  Antracite
Anthracite
- X=4  Silver

Diffusore - Diffuser
Codice-Code **08 8045**
policarbonato trasparente/
transparent polycarbonate

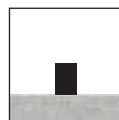

Installazione a terra
Floor mounting

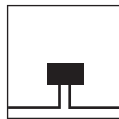

Doppia entrata cavi di alimentazione
Double power supply cables input

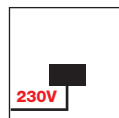

L'apparecchio è fornito completo di alimentatore elettronico 220/240V 50/60Hz posizionato all'interno dell'apparecchio.
The luminaire is supplied with a 220/240V 50/60Hz built-in power supply.

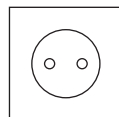

Compreso di controbase di fissaggio a terra
Root-mount ground fixing enclosed

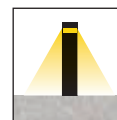

L'emissione di luce verso il basso è nel pieno rispetto delle leggi contro l'inquinamento luminoso.

The direct light emission is in full compliance with standard light pollution directives

OPTIONAL Cod. TR 8049

Flangia: accessorio per palo.
Flange: accessory for post.

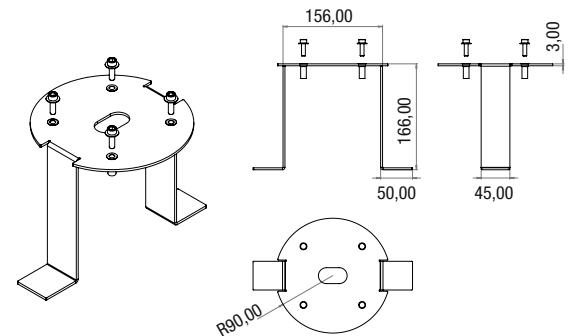



8045 H 400

8045.66X	LED	25W	3020 lm	4000 K
8045.67X	LED	25W	2880 lm	3000 K
8045.36X	LED	40W	4150 lm	4000 K
8045.37X	LED	40W	3900 lm	3000 K

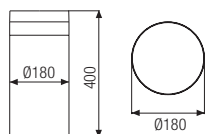

8047 H 700

8047.66X	LED	25W	3020 lm	4000 K
8047.67X	LED	25W	2880 lm	3000 K
8047.36X	LED	40W	4150 lm	4000 K
8047.37X	LED	40W	3900 lm	3000 K

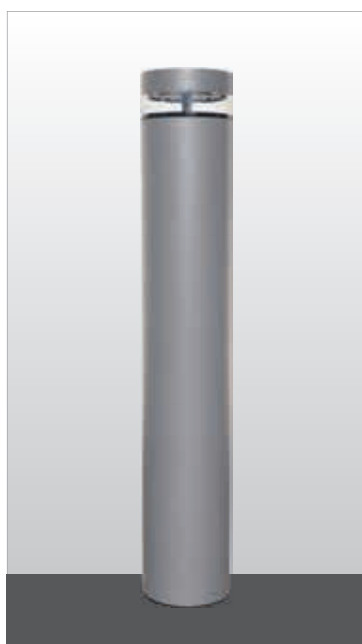
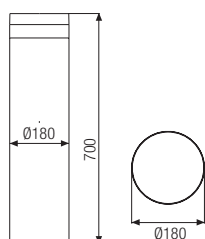

8049 H 1040

8049.66X	LED	25W	3020 lm	4000 K
8049.67X	LED	25W	2880 lm	3000 K
8049.36X	LED	40W	4150 lm	4000 K
8049.37X	LED	40W	3900 lm	3000 K

