

VIVIDA TECHNOLOGY

TECNICO LED COLLECTION . 5



LED 5



Nuova collezione LED di faretti, pannelli, plafoniere e lampade da esterno da incasso e non, sviluppati da Vivida Technology per realizzare progetti di illuminotecnica funzionali, ad alto contenuto estetico ed ecosostenibile.



A new collection of LED spotlights, panels, ceiling lights and outdoor recessed and non recessed lights, developed by Vivida Technology to realize functional lighting engineering projects, environmentally sustainable and with high aesthetic content.

FARETTI INCASSO LED | 07
COB LED SPOTLIGHTS

PANNELLI INCASSO LED | 29
LED PANEL LIGHTS

PLAFONIERE LED | 39
SURFACE LED PANEL LIGHTS

LAMPADE LED A SOSPENSIONE | 61
PENDANT LED LIGHTS

LAMPADE LED DA ESTERNO | 65
LED GARDEN LIGHTS



VIVIDA

LUCI NEL MONDO

*Che mondo sarebbe senza la luce?
La luce... ispiratrice di emozioni... una fonte di energia...
non solo per la vita quotidiana,
ma anche per la sua dimensione interiore: la più creativa!*

A questo scopo nell'ottobre 2005 è nata VIVIDA SRL.

*Si è soliti dire che nella botte piccola c'è il vino buono!!
... ed è proprio così che VIVIDA SRL è partita come una piccola ditta,
che giorno dopo giorno, con sacrifici ed obiettivi ben precisi
si è sviluppata ed ingrandita sempre di più stando costantemente al passo
con gli stili, i gusti e le tendenze del momento.*

*Questo catalogo con ogni singolo suo prodotto
è stato frutto di tanta passione e determinazione
da parte di ogni singolo componente che, day by day e step by step,
si impegna per migliorare sempre di più!*

*Lasciatevi coinvolgere dalle nostre nuove proposte,
Lasciate scorrere l'immaginazione,
perché la luce crei la vostra personale dimensione!*

Perché la luce è vita!!

*"Guarda la luce
E l'ombra ti cadrà alle spalle"*

- Rita Levi Montalcini -



Classe di protezione IP

Il sistema IP (Ingress Protection) viene pubblicato dalla IEC 529 (International Electrotechnical Commission) e classifica il grado di protezione che l'alloggiamento fornisce nei confronti di oggetti solidi e liquidi al fine di utilizzare l'apparecchio elettrico ivi contenuto.

IP **X** **X**
1° cifra 2° cifra

Il grado IP è indicato con due cifre caratteristiche più eventuali due lettere aggiuntive.

simbolo	1° CIFRA Protezione contro l'accesso di corpi solidi	2° CIFRA Protezione contro l'accesso di liquidi
IP	0 Nessuna protezione	0 Nessuna protezione
	1 Protetto contro corpi solidi di dimensioni superiori a 50mm, ad es. mani	1 Protetto contro la caduta verticale di gocce d'acqua
	2 Protetto contro corpi solidi di dimensioni superiori a 12mm, ad es. dita umane	2 Protetto contro la caduta di gocce d'acqua con inclinazione massima di 15° dalla verticale
	3 Protetto contro corpi solidi di dimensioni superiori a 2.5mm, ad es. attrezzi, fili sottili	3 Protetto contro spruzzi d'acqua diretti con inclinazione massima di 60° dalla verticale
	4 Protetto contro corpi solidi di dimensioni superiori a 1mm, ad es. fili, viti	4 Protetto contro spruzzi d'acqua provenienti da qualsiasi direzione
	5 Protetto contro la polvere, ingresso limitato (deposito non pericoloso)	5 Protetto contro getti d'acqua a bassa pressione provenienti da qualsiasi direzione
	6 Totalmente protetto contro la polvere.	6 Protetto contro getti d'acqua ad alta pressione provenienti da qualsiasi direzione
		7 Protetto contro l'immersione fino a 1m di profondità
	8 Protetto contro la prolungata immersione a oltre 1m di profondità	

Legenda

● Luce Calda

● Luce Fredda

■ Colore - Bianco

■ Colore - Grigio

■ Colore - Antracite

■ Colore - Nero



Non dimmerabile



Dimmerabile



Protection Class IP

The IP (Ingress Protection) rating system is published by the IEC 529 (International Electrotechnical Commission) and classifies the degree of protection that the enclosure provides against solid objects and liquids in order to operate the enclosed electrical equipment.

IP **X** **X**
1° digit 2° digit

The IP is indicated by two digits characteristics plus any two additional letters.

symbol	1° DIGIT Protection Against Solid Objects	2° DIGIT Protection Against Liquids
IP	0 No Protection	0 No Protection
	1 Protected Against Solid Objects Bigger than 50mm e.g. Hands	1 Protection Against Vertically Falling Dripping Water
	2 Protected Against Solid Objects Bigger than 12 mm, e.g. Persons Fingers	2 Protection Against Dripping Water up to 15° from Vertical
	3 Protected Against Solid Objects Bigger than 2.5 mm e.g. Tools, Thick Wires	3 Protected Against Direct Sprays of Water up to 60° from Vertical
	4 Protected Against Solid Objects Bigger than 1 mm e.g. Wires, Screws	4 Protected Against Water Splashing from any Direction
	5 Protected Against Dust Limited Ingress (no Harmful Deposit)	5 Protected Against Low Pressure Water Jets from any Direction
	6 Totally Protected Against Dust.	6 Protected Against High Pressure Water Jets from any Direction
		7 Protected Against Immersion up to 1 m
		8 Protected Against Long Periods of Immersion under Pressure

Legend

- Warm light
- Cold Light

- Color - White
- Color - Silver

- Color - Dark grey
- Color - Black



Not dimmable



Dimmable

FARETTI INCASSO LED
COB LED SPOTLIGHTS

BIANCO/WHITE

GRIGIO / SILVER

VRD 01_05 BI W
VRD 01_05 BI

VRD 01_05 SL W
VRD 01_05 SL

VRD 02_05 BI W
VRD 02_05 BI

VRD 02_05 SL W
VRD 02_05 SL

VRD 04_03 BI W
VRD 04_03 BI
VRD 04_05 BI W
VRD 04_05 BI
VRD 04_08 BI W
VRD 04_08 BI

VRD 04_03 SL W
VRD 04_03 SL
VRD 04_05 SL W
VRD 04_05 SL
VRD 04_08 SL W
VRD 04_08 SL

VRD 05_03 BI W
VRD 05_03 BI

VRD 05_03 SL W
VRD 05_03 SL

VRD 06_03 BI W
VRD 06_03 BI

VRD 06_03 SL W
VRD 06_03 SL

VRD 16_05 BI 3000K
VRD 16_05 BI 4000K
VRD 16_06 BI 3000K
VRD 16_06 BI 4000K

VRD 17_05 BI 3000K
VRD 17_05 BI 4000K
VRD 17_06 BI 3000K
VRD 17_06 BI 4000K

VRD 18_05 BI 3000K
VRD 18_05 BI 4000K

VRD 20_09 BI



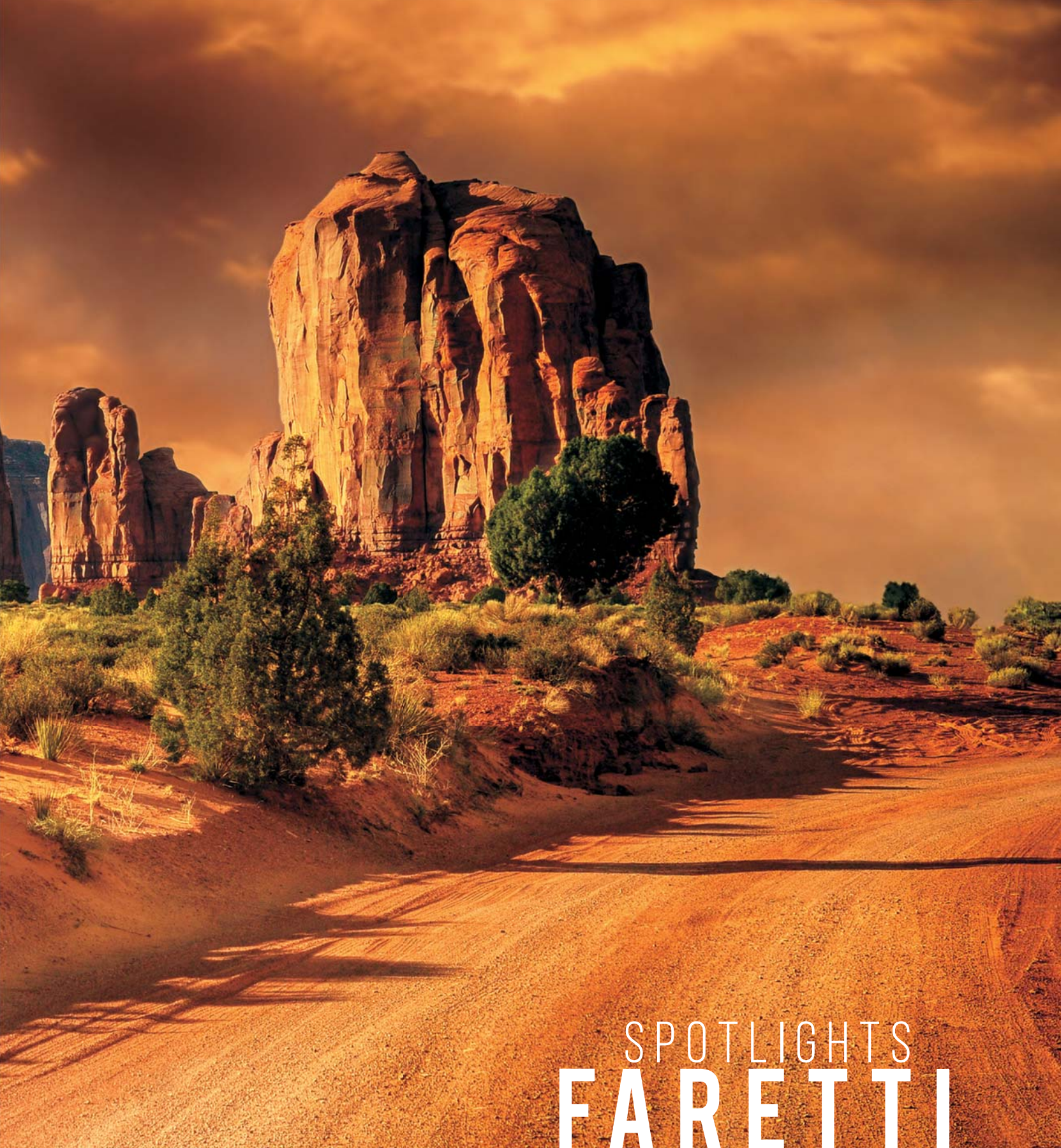

SPOTLIGHTS
FARETTI



CLAIRE: faretto incasso tondo cob led, orientabile con finitura bianca o grigia.
CLAIRE: cob led recessed spotlight - round, orientable, white or silver.

VRD 01

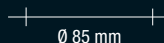

articolo / item	VRD 01_05 BI W ● 3000 K 384 lumen VRD 01_05 BI ● 4000 K 402 lumen	VRD 01_05 SL W ● 3000 K 384 lumen VRD 01_05 SL ● 4000 K 402 lumen
finitura / finished	bianco / white ■	grigio / silver ■
voltaggio / voltage	AC 220-240V ~ 50/60 Hz	AC 220-240V ~ 50/60 Hz
driver	compreso / included	compreso / included
misure / measures	Ø 85 mm, H 48 mm	Ø 85 mm, H 48 mm
foro / hole	Ø 70 mm	Ø 70
angolo / beam angle	90°	90°
durata / life	30.000 ore / hours	30.000 ore / hours
materiale / material	Alluminio / Aluminium	Alluminio / Aluminium
peso / weight	0,172 kg	0,172 kg

5W  **IP20**



5W  **IP20**





KARLY: faretto incasso quadro cob led, orientabile con finitura bianca o grigia.
KARLY: cob led recessed spotlight - squared, orientable, white or silver.

VRD 02

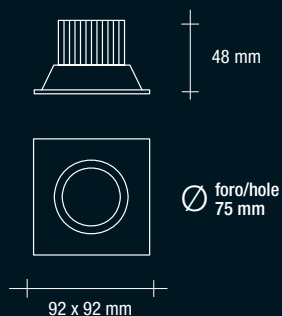

articolo / item	VRD 02_05 BI W ● 3000 K 392 lumen VRD 02_05 BI ● 4000 K 421 lumen	VRD 02_05 SL W ● 3000 K 392 lumen VRD 02_05 SL ● 4000 K 421 lumen
finitura / finished	bianco / white ■	grigio / silver ■
voltaggio / voltage	AC 220-240V ~ 50/60 Hz	AC 220-240V ~ 50/60 Hz
driver	compreso / included	compreso / included
misure / measures	92 x 92 mm, H 48 mm	92 x 92 mm, H 48 mm
foro / hole	Ø 75 mm	Ø 75 mm
angolo / beam angle	90°	90°
durata / life	30.000 ore / hours	30.000 ore / hours
materiale / material	Alluminio / Aluminium	Alluminio / Aluminium
peso / weight	0,20 kg	0,20 kg

5W  IP20

1 pz 50 pz

5W  IP20

1 pz 50 pz



ALYS: faretto incasso tondo cob led, orientabile con finitura bianca o grigia.
ALYS: cob led recessed spotlight - round, orientable, white or silver.

VRD 04

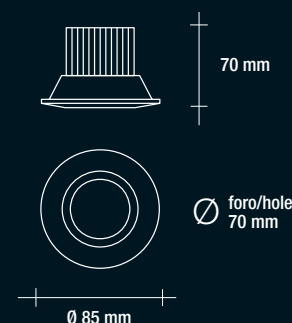
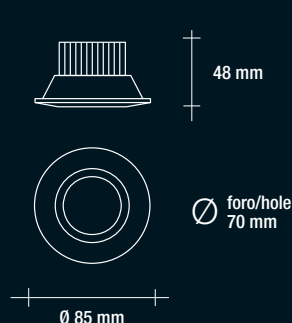
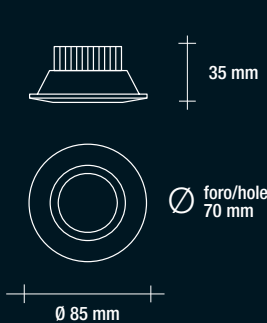

articolo / item	VRD 04_03 BI W VRD 04_03 SL W <ul style="list-style-type: none"> ● 3000 K 220 lumen VRD 04_03 BI VRD 04_03 SL <ul style="list-style-type: none"> ● 4000 K 229 lumen 	VRD 04_05 BI W VRD 04_05 SL W <ul style="list-style-type: none"> ● 3000 K 385 lumen VRD 04_05 BI VRD 04_05 SL <ul style="list-style-type: none"> ● 4000 K 399 lumen 	VRD 04_08 BI W VRD 04_08 SL W <ul style="list-style-type: none"> ● 3000 K 580 lumen VRD 04_08 BI VRD 04_08 SL <ul style="list-style-type: none"> ● 4000 K 584 lumen
finitura / finished	bianco / white grigio / silver 	bianco / white grigio / silver 	bianco / white grigio / silver
voltaggio / voltage	AC 220-240V ~ 50/60 Hz	AC 220-240V ~ 50/60 Hz	AC 220-240V ~ 50/60 Hz
driver	compreso / included	compreso / included	compreso / included
misure / measures	Ø 85 mm, H 35 mm	Ø 85 mm, H 48 mm	Ø 85 mm, H 70 mm
foro / hole	Ø 70 mm	Ø 70 mm	Ø 70 mm
angolo / beam angle	90°	90°	90°
durata / life	30.000 ore / hours	30.000 ore / hours	30.000 ore / hours
materiale / material	Alluminio / Aluminium	Alluminio / Aluminium	Alluminio / Aluminium
peso / weight	0,15 kg	0,19 kg	0,22 kg

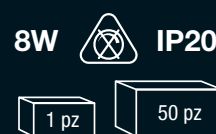
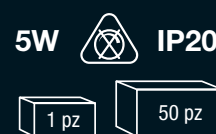



MONIQUE: piccolo faretto ad incasso, cob led, tondo, orientabile, con finitura bianca o grigia.
MONIQUE: little cob led recessed spotlight - round, orientable, white or silver.

VRD 05

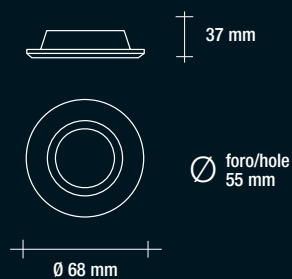

articolo / item	VRD 05_03 BI W ● 3000 K 230 lumen VRD 05_03 BI ● 4000 K 246 lumen	VRD 05_03 SL W ● 3000 K 230 lumen VRD 05_03 SL ● 4000 K 246 lumen
finitura / finished	bianco / white ■	grigio / silver ■
voltaggio / voltage	AC 220-240V ~ 50/60 Hz	AC 220-240V ~ 50/60 Hz
driver	compreso / included	compreso / included
misure / measures	Ø 68 mm, H 37 mm	Ø 68 mm, H 37 mm
foro / hole	Ø 55 mm	Ø 55 mm
angolo / beam angle	40°	40°
durata / life	30.000 ore / hours	30.000 ore / hours
materiale / material	Alluminio / Aluminium	Alluminio / Aluminium
peso / weight	0,144 kg	0,144 kg

3W  IP20

1 pz 50 pz

3W  IP20

1 pz 50 pz



SYLVIE: piccolo faretto ad incasso, cob led, quadrato, orientabile, con finitura bianca o grigia.
SYLVIE: little cob led recessed spotlight - squared, orientable, white or silver.

VRD 06

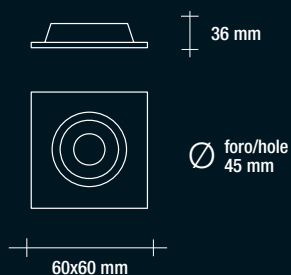

articolo / item	VRD 06_03 BI W ● 3000 K 259 lumen VRD 06_03 BI ● 4000 K 265 lumen	VRD 06_03 SL W ● 3000 K 259 lumen VRD 06_03 SL ● 4000 K 265 lumen
finitura / finished	bianco / white ■	grigio / silver ■
voltaggio / voltage	AC 220-240V ~ 50/60 Hz	AC 220-240V ~ 50/60 Hz
driver	compreso / included	compreso / included
misure / measures	60 x 60 mm, H 36 mm	60 x 60 mm, H 36 mm
foro / hole	Ø 45 mm	Ø 45 mm
angolo / beam angle	40°	40°
durata / life	30.000 ore / hours	30.000 ore / hours
materiale / material	Alluminio / Aluminium	Alluminio / Aluminium
peso / weight	0,154 kg	0,154 kg

3W  **IP20**



3W  **IP20**





GEORGE: faretto incasso tondo cob led, fisso, con finitura bianca.

GEORGE: cob led recessed spotlight - round, fix, white.

VRD 16

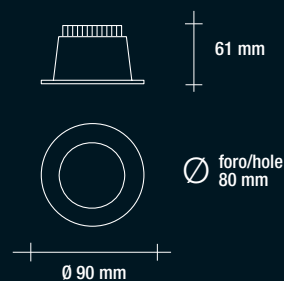
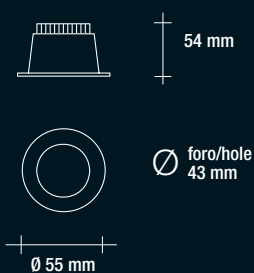
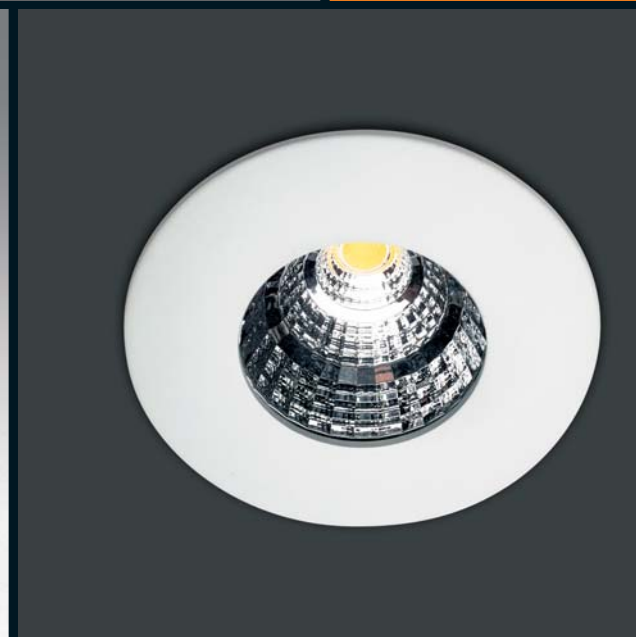

VRD 16_05 BI 3000K

- 3000 K
350 lumen

VRD 16_05 BI 4000K

- 4000 K
370 lumen

VRD 16_06 BI 3000K

- 3000 K
480 lumen

VRD 16_06 BI 4000K

- 4000 K
500 lumen

articolo / item

finitura / finished

bianco / white ■

bianco / white ■

voltaggio / voltage

AC 220-240V, 50/60 Hz

AC 220-240V, 50/60 Hz

driver

compreso / included

compreso / included

misure / measures

Ø 55 mm, H 54 mm

Ø 90 mm, H 61 mm

foro / hole

Ø 43 mm

Ø 80 mm

angolo / beam angle

24°

21°

durata / life

30.000 ore / hours

30.000 ore / hours

materiale / material

Struttura in pressofusione alluminio + copertura in vetro
Die - casting aluminium body + glass cover

Struttura in pressofusione alluminio + copertura in vetro
Die - casting aluminium body + glass cover

peso / weight

0,15 kg

0,30 kg

5W  IP20

 10 pz  50 pz

6W  IP20

 10 pz  50 pz



MARK: faretto incasso quadro cob led, fisso, con finitura bianca.
MARK: cob led recessed spotlight - squared, fix, white.

VRD 17

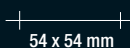

VRD 17_05 BI 3000K

- 3000 K
350 lumen

VRD 17_05 BI 4000K

- 4000 K
370 lumen

VRD 17_06 BI 3000K

- 3000 K
480 lumen

VRD 17_06 BI 4000K

- 4000 K
500 lumen

articolo / item

finitura / finished

bianco / white ■

bianco / white ■

voltaggio / voltage

AC 220-240V, 50/60 Hz

AC 220-240V, 50/60 Hz

driver

compreso / included

compreso / included

misure / measures

54 x 54 mm, H 54 mm

90 x 90 mm, H 65 mm

foro / hole

Ø 43 mm

Ø 80 mm

angolo / beam angle

24°

21°

durata / life

30.000 ore / hours

30.000 ore / hours

materiale / material

Struttura in pressofusione alluminio + copertura in vetro
 Die - casting aluminium body + glass cover

Struttura in pressofusione alluminio + copertura in vetro
 Die - casting aluminium body + glass cover

peso / weight

0,15 kg

0,30 kg

5W  IP20



6W  IP20





JUMP: faretto incasso tondo cob led, orientabile, con finitura bianca.
JUMP: cob led recessed spotlight - round, orientable, white.

VRD 18



articolo / item

VRD 18_05 BI 3000K

- 3000 K
350 lumen

VRD 18_05 BI 4000K

- 4000 K
370 lumen

finitura / finished	bianco / white
voltaggio / voltage	AC 220-240V, 50/60 Hz
driver	compreso / included
misure / measures	Ø 87 mm, H 45 mm
foro / hole	Ø 77 mm
angolo / beam angle	87°
durata / life	30.000 ore / hours
materiale / material	Struttura in pressofusione alluminio + copertura in vetro Die - casting aluminium body + glass cover
peso / weight	0,10 kg

5W  **IP20**

10 pz **50 pz**







CRAZY: pannello ad incasso tondo led, con finitura bianca.
CRAZY: led recessed panel light - round and white.

VRD 20

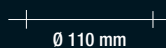

Possibilità di poter scegliere la temperatura colore
 Possibility to choose the color temperature (3000k, 4000k, 5000k)

 **DIMMERABILE / DIMMABLE : TRAILING EDGE DIMMER**

articolo / item

- **VRD 20_09 BI 3000K**
3000 K
730 lumen
- **VRD 20_09 BI 4000K**
4000 K
820 lumen
- **VRD 20_09 BI 5000K**
5000 K
900 lumen

finitura / finished	bianco / white 
voltaggio / voltage	AC 180-265V, 50/60 Hz
driver	compreso / included
misure / measures	Ø 110 mm, H 65 mm
foro / hole	Ø 90 mm
angolo / beam angle	90°
durata / life	30.000 ore / hours
materiale / material	PBT + Alluminio / PBT + Aluminium
peso / weight	0,14 kg

9W  **IP20**



PANNELLI INCASSO LED
LED PANEL LIGHTS

BIANCO/WHITE

GRIGIO / SILVER

VRD 13_03 BI
VRD 13_03 FR BI

VRD 13_03 SL
VRD 13_03 FR SL

VRD 13_06 BI
VRD 13_06 FR BI

VRD 13_06 SL
VRD 13_06 FR SL

VRD 13_09 BI
VRD 13_09 FR BI

VRD 13_09 SL
VRD 13_09 FR SL

VRD 13_12 BI
VRD 13_12 FR BI

VRD 13_12 SL
VRD 13_12 FR SL

VRD 13_18 BI
VRD 13_18 FR BI

VRD 13_18 SL
VRD 13_18 FR SL

VRD 13_24 BI
VRD 13_24 FR BI

VRD 13_24 SL
VRD 13_24 FR SL

VRD 14_03 BI
VRD 14_03 FR BI

VRD 14_03 SL
VRD 14_03 FR SL

VRD 14_06 BI
VRD 14_06 FR BI

VRD 14_06 SL
VRD 14_06 FR SL

VRD 14_09 BI
VRD 14_09 FR BI

VRD 14_09 SL
VRD 14_09 FR SL

VRD 14_12 BI
VRD 14_12 FR BI

VRD 14_12 SL
VRD 14_12 FR SL

VRD 14_18 BI
VRD 14_18 FR BI

VRD 14_18 SL
VRD 14_18 FR SL

VRD 14_24 BI
VRD 14_24 FR BI

VRD 14_24 SL
VRD 14_24 FR SL

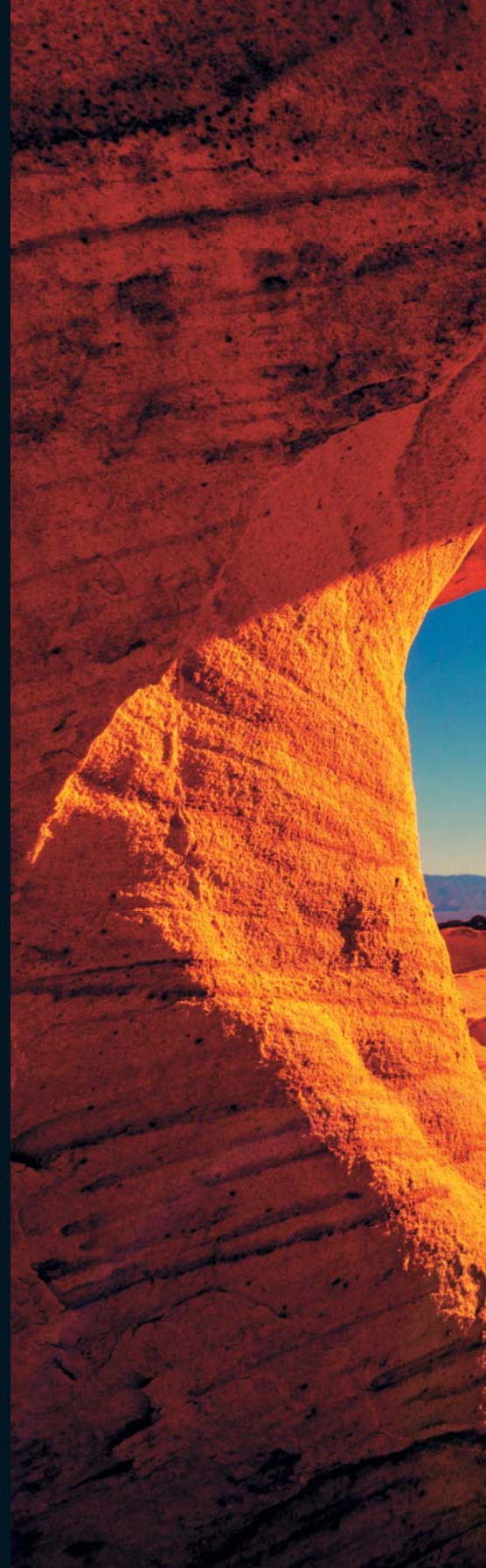

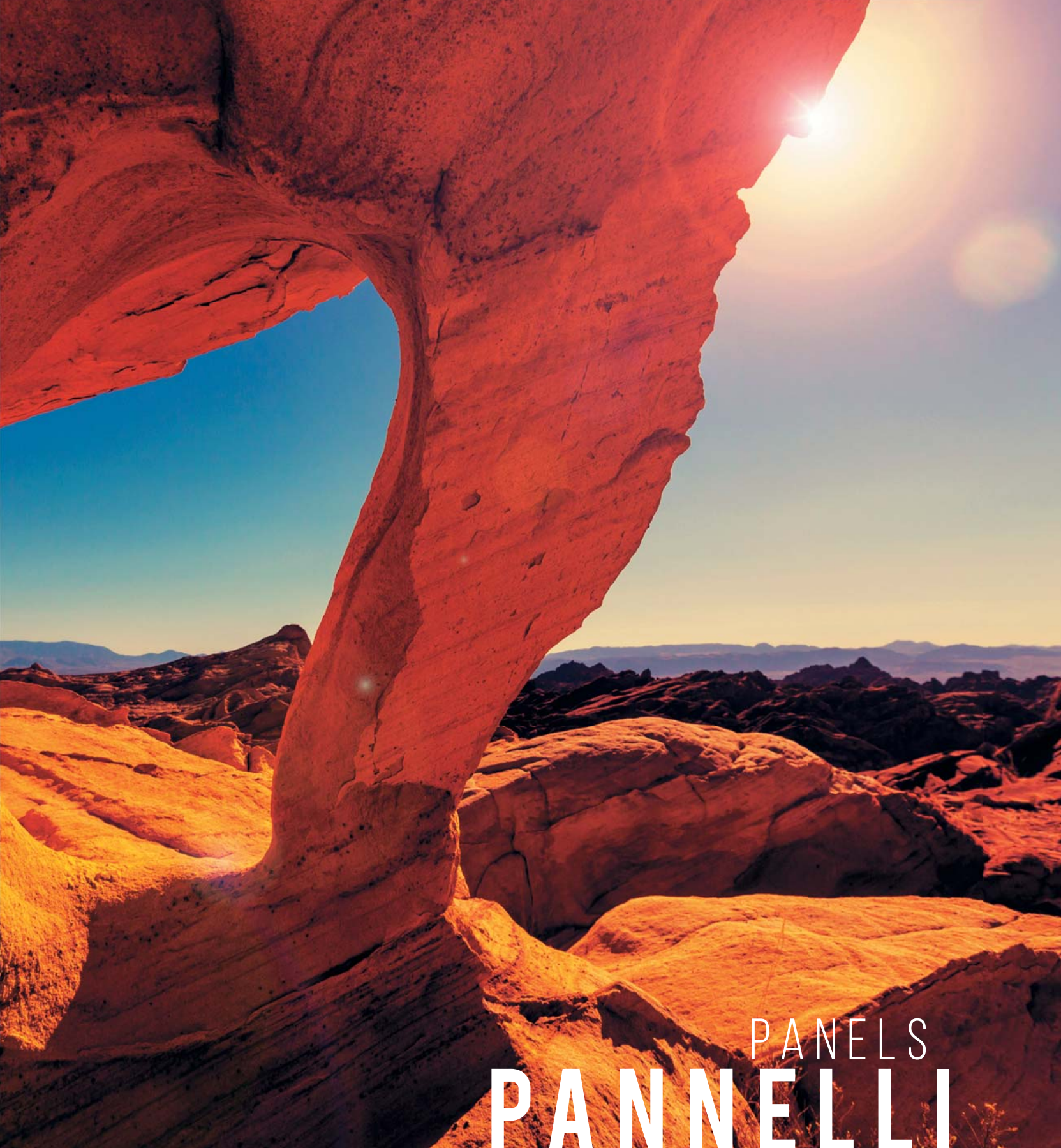

PANELS
PANNELLI



SUMMER: pannello ad incasso tondo led, con finitura bianca o grigia.
SUMMER: led recessed panel light - round, white or silver.

VRD 13

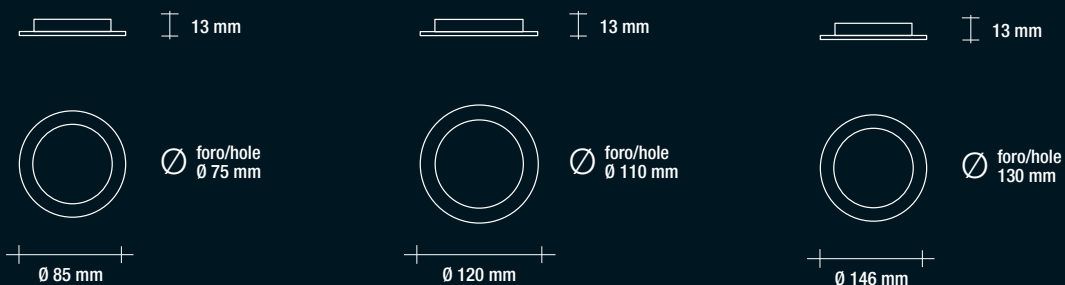

VRD 13_03 BI
VRD 13_03 SL

● 3000 K
 203 lumen

VRD 13_03 FR BI
VRD 13_03 FR SL

● 4000 K
 219 lumen

VRD 13_06 BI
VRD 13_06 SL

● 3000 K
 410 lumen

VRD 13_06 FR BI
VRD 13_06 FR SL

● 4000 K
 445 lumen

VRD 13_09 BI
VRD 13_09 SL

● 3000 K
 598 lumen

VRD 13_09 FR BI
VRD 13_09 FR SL

● 4000 K
 640 lumen

articolo / item

finitura / finished	bianco / white <input type="checkbox"/> grigio / silver <input type="checkbox"/>	bianco / white <input type="checkbox"/> grigio / silver <input type="checkbox"/>	bianco / white <input type="checkbox"/> grigio / silver <input type="checkbox"/>
voltaggio / voltage	AC 220-240V, 50/60 Hz	AC 220-240V, 50/60 Hz	AC 220-240V, 50/60 Hz
driver	compreso / included	compreso / included	compreso / included
misure / measures	Ø 85 mm, H 13 mm	Ø 120 mm, H 13 mm	Ø 146 mm, H 13 mm
foro / hole	Ø 75 mm	Ø 110 mm	Ø 130 mm
angolo / beam angle	120°	120°	120°
durata / life	30.000 ore / hours	30.000 ore / hours	30.000 ore / hours
materiale / material	Alluminio / Aluminium	Alluminio / Aluminium	Alluminio / Aluminium
peso / weight	0,105 kg	0,16 kg	0,21 kg

3W **IP20**

1 pz 100 pz

6W **IP20**

1 pz 40 pz

9W **IP20**

1 pz 40 pz



SUMMER: pannello ad incasso tondo led, con finitura bianca o grigia.
SUMMER: led recessed panel light - round, white or silver.

VRD 13



articolo / item

VRD 13_12 BI
VRD 13_12 SL

- 3000 K
878 lumen

VRD 13_12 FR BI
VRD 13_12 FR SL

- 4000 K
922 lumen

VRD 13_18 BI
VRD 13_18 SL

- 3000 K
1310 lumen

VRD 13_18 FR BI
VRD 13_18 FR SL

- 4000 K
1411 lumen

VRD 13_24 BI
VRD 13_24 SL

- 3000 K
1692 lumen

VRD 13_24 FR BI
VRD 13_24 FR SL

- 4000 K
1812 lumen

finitura / finished

bianco / white ■ grigio / silver ■

voltaggio / voltage

AC 220-240V, 50/60 Hz

driver

compreso / included

misure / measures

Ø 170 mm, H 13 mm

foro / hole

Ø 160 mm

angolo / beam angle

120°

durata / life

30.000 ore / hours

materiale / material

Alluminio / Aluminium

peso / weight

0,27 kg

bianco / white ■ grigio / silver ■

AC 220-240V, 50/60 Hz

compreso / included

Ø 220 mm, H 13 mm

Ø 205 mm

120°

30.000 ore / hours

Alluminio / Aluminium

0,435 kg

bianco / white ■ grigio / silver ■

AC 220-240V, 50/60 Hz

compreso / included

Ø 300 mm, H 13 mm

Ø 280 mm

120°

30.000 ore / hours

Alluminio / Aluminium

0,77 kg

12W  **IP20**



18W  **IP20**



24W  **IP20**





WINTER: pannello ad incasso quadro led, con finitura bianca e grigia.
WINTER: led recessed panel light, square, with white and silver finished.

VRD 14

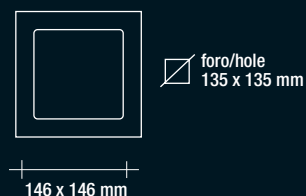
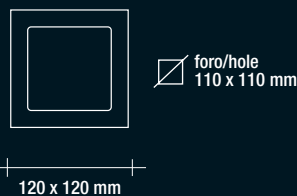
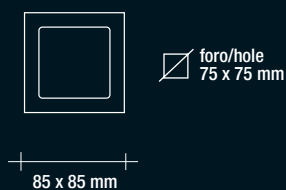

VRD 14_03 BI
VRD 14_03 SL

● 3000 K
 208 lumen

VRD 14_03 FR BI
VRD 14_03 FR SL

● 4000 K
 218 lumen

VRD 14_06 BI
VRD 14_06 SL

● 3000 K
 411 lumen

VRD 14_06 FR BI
VRD 14_06 FR SL

● 4000 K
 449 lumen

VRD 14_09 BI
VRD 14_09 SL

● 3000 K
 607 lumen

VRD 14_09 FR BI
VRD 14_09 FR SL

● 4000 K
 645 lumen

articolo / item

finitura / finished	bianco / white <input type="checkbox"/> grigio / silver <input type="checkbox"/>	bianco / white <input type="checkbox"/> grigio / silver <input type="checkbox"/>	bianco / white <input type="checkbox"/> grigio / silver <input type="checkbox"/>
voltaggio / voltage	AC 220-240V, 50/60 Hz	AC 220-240V, 50/60 Hz	AC 220-240V, 50/60 Hz
driver	compreso / included	compreso / included	compreso / included
misure / measures	85 x 85 mm, H 13 mm	120 x 120 mm, H 13 mm	146 x 146 mm, H 13 mm
foro / hole	75 x 75 mm	110 x 110 mm	135 x 135 mm
angolo / beam angle	120°	120°	120°
durata / life	30.000 ore / hours	30.000 ore / hours	30.000 ore / hours
materiale / material	Alluminio / Aluminium	Alluminio / Aluminium	Alluminio / Aluminium
peso / weight	0,11 kg	0,20 kg	0,26 kg





WINTER: pannello ad incasso quadro led, con finitura bianca o grigia.
WINTER: led recessed panel light - squared, white or silver.

VRD 14

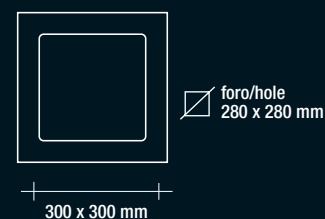
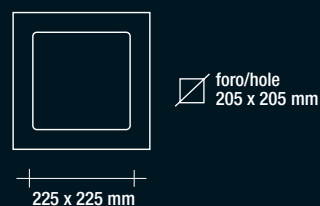
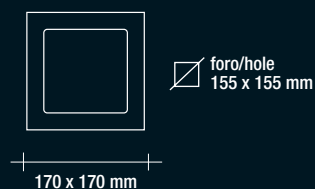
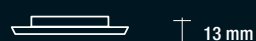
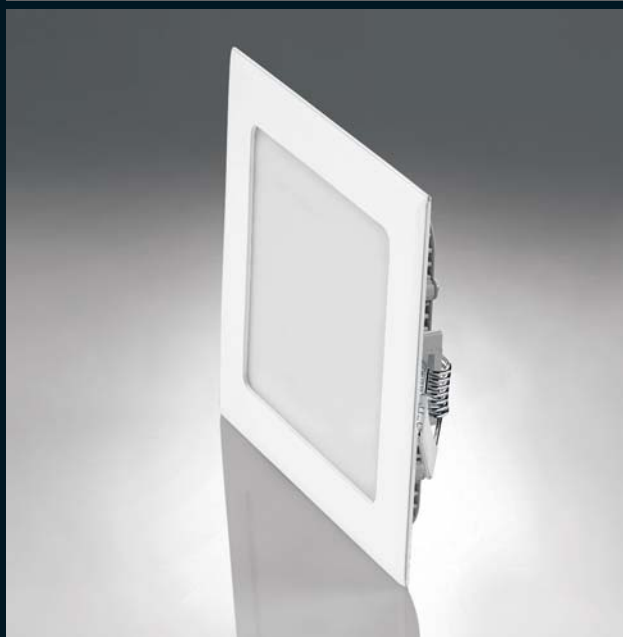

articolo / item

VRD 14_12 BI
VRD 14_12 SL

- 3000 K
847 lumen

VRD 14_12 FR BI
VRD 14_12 FR SL

- 4000 K
923 lumen

VRD 14_18 BI
VRD 14_18 SL

- 3000 K
1346 lumen

VRD 14_18 FR BI
VRD 14_18 FR SL

- 4000 K
1401 lumen

VRD 14_24 BI
VRD 14_24 SL

- 3000 K
1692 lumen

VRD 14_24 FR BI
VRD 14_24 FR SL

- 4000 K
1792 lumen

finitura / finished

bianco / white grigio / silver

bianco / white grigio / silver

bianco / white grigio / silver

voltaggio / voltage

AC 220-240V, 50/60 Hz

AC 220-240V, 50/60 Hz

AC 220-240V, 50/60 Hz

driver

compreso / included

compreso / included

compreso / included

misura / measures

170 X 170 mm, H 13 mm

225 x 225 mm, H 13 mm

300 x 300 mm, H 13 mm

foro / hole

155 x 155 mm

205 x 205 mm

280 x 280 mm

angolo / beam angle

120°

120°

120°

durata / life

30.000 ore / hours

30.000 ore / hours

30.000 ore / hours

materiale / material

Alluminio / Aluminium

Alluminio / Aluminium

Alluminio / Aluminium

peso / weight

0,32 kg

0,44 kg

0,78 kg

12W  **IP20**



18W  **IP20**



24W  **IP20**



PLAFONIERE LED
SURFACE LED PANEL LIGHTS

BIANCO/WHITE

VPL 01_06 3000K
VPL 01_06 4000K
VPL 01_12 3000K
VPL 01_12 4000K
VPL 01_18 3000K
VPL 01_18 4000K
VPL 01_24 3000K
VPL 01_24 4000K

VPL 02_06 3000K
VPL 02_06 4000K
VPL 02_12 3000K
VPL 02_12 4000K
VPL 02_18 3000K
VPL 02_18 4000K
VPL 02_24 3000K
VPL 02_24 4000K

VPL 03_14 3000K
VPL 03_20 3000K
VPL 03_28 3000K

VPL 04_14 3000K
VPL 04_20 3000K
VPL 04_28 3000K

VPL 05_18 3000K
VPL 05_24 3000K
VPL 05_30 3000K

VOD 58_12 BI 3000K
VOD 58_18 BI 3000K

VPL 06_10 BI 3000K
VPL 06_15 BI 3000K
VPL 06_20 BI 3000K
VPL 06_25 BI 3000K

VPL 07_07 BI 3000K
VPL 07_12 BI 3000K
VPL 07_18 BI 3000K
VPL 07_30 BI 3000K

VPL 08_07 BI 3000K
VPL 08_12 BI 3000K
VPL 08_18 BI 3000K
VPL 08_30 BI 3000K

VPL 09_07 BI 3000K
VPL 09_12 BI 3000K













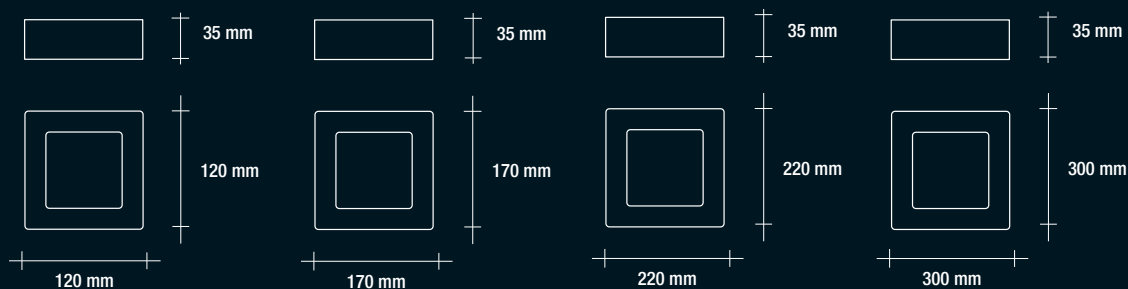
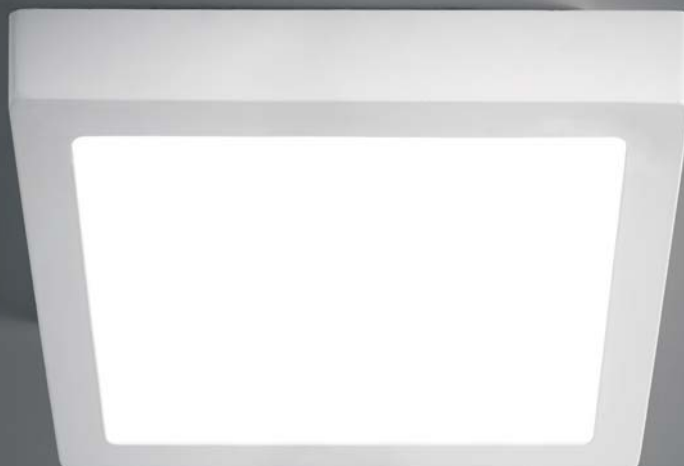



SURFACE LED PANEL LIGHTS
PLAFONIERE

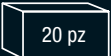

AUTUMN: plafoniera quadra led con finitura bianca.
AUTUMN: surface led panel light - squared and white.

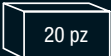
VPL 01



articolo / item	VPL 01_06 3000K ● 3000 K 409 lumen	VPL 01_12 3000K ● 3000 K 877 lumen	VPL 01_18 3000K ● 3000 K 1310 lumen	VPL 01_24 3000K ● 3000 K 1773 lumen
	VPL 01_06 4000K ● 4000 K 443 lumen	VPL 01_12 4000K ● 4000 K 926 lumen	VPL 01_18 4000K ● 4000 K 1394 lumen	VPL 01_24 4000K ● 4000 K 1816 lumen
finitura / finished	bianco / white ■	bianco / white ■	bianco / white ■	bianco / white ■
voltaggio / voltage	AC 220-240V, 50/60 Hz	AC 220-240V, 50/60 Hz	AC 220-240V, 50/60 Hz	AC 220-240V, 50/60 Hz
driver	compreso / included	compreso / included	compreso / included	compreso / included
misure / measures	120 x 120 mm, H 35 mm	170 x 170 mm, H 35 mm	220 x 220 mm, H 35 mm	300 x 300 mm, H 35 mm
angolo / beam angle	120°	120°	120°	120°
durata / life	30.000 ore / hours	30.000 ore / hours	30.000 ore / hours	30.000 ore / hours
materiale / material	Alluminio / Aluminium	Alluminio / Aluminium	Alluminio / Aluminium	Alluminio / Aluminium
peso / weight	0,25 kg	0,41 kg	0,69 kg	1,10 kg
	6W  IP20  	12W  IP20  	18W  IP20  	24W  IP20  



SPRING: plafoniera tonda led con finitura bianca.
SPRING: surface led panel light - round and white.

VPL 02

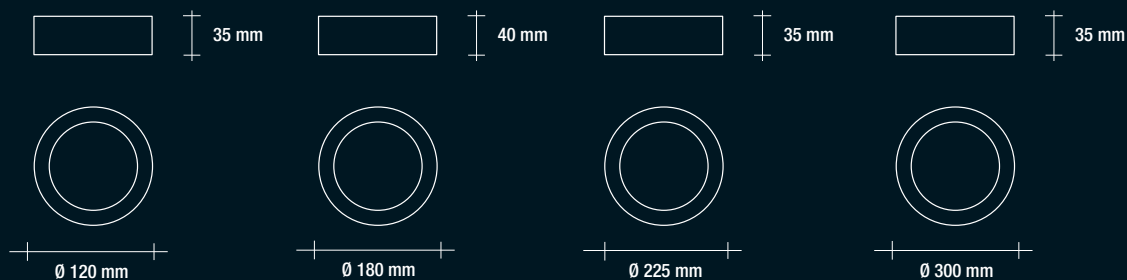

articolo / item	VPL 02_06 3000K <ul style="list-style-type: none"> ● 3000 K 409 lumen VPL 02_06 4000K <ul style="list-style-type: none"> ● 4000 K 442 lumen 	VPL 02_12 3000K <ul style="list-style-type: none"> ● 3000 K 859 lumen VPL 02_12 4000K <ul style="list-style-type: none"> ● 4000 K 865 lumen 	VPL 02_18 3000K <ul style="list-style-type: none"> ● 3000 K 1304 lumen VPL 02_18 4000K <ul style="list-style-type: none"> ● 4000 K 1394 lumen 	VPL 02_24 3000K <ul style="list-style-type: none"> ● 3000 K 1657 lumen VPL 02_24 4000K <ul style="list-style-type: none"> ● 4000 K 1820 lumen
finitura / finished	bianco / white	bianco / white	bianco / white	bianco / white
voltaggio / voltage	AC 220-240V, 50/60 Hz	AC 220-240V, 50/60 Hz	AC 220-240V, 50/60 Hz	AC 220-240V, 50/60 Hz
driver	compreso / included	compreso / included	compreso / included	compreso / included
misure / measures	Ø 120 mm, H 35 mm	Ø 180 mm, H 40 mm	Ø 225 mm, H 35 mm	Ø 300 mm, H 35 mm
angolo / beam angle	120°	120°	120°	120°
durata / life	30.000 ore / hours	30.000 ore / hours	30.000 ore / hours	30.000 ore / hours
materiale / material	Alluminio / Aluminium	Alluminio / Aluminium	Alluminio / Aluminium	Alluminio / Aluminium
peso / weight	0,24 kg	0,39 kg	0,65 kg	1,05 kg
	6W IP20 	12W IP20 	18W IP20 	24W IP20



FAST: plafoniera led in plastica, quadra, con finitura bianca.
FAST: led ceiling light - squared and white.

VPL 03

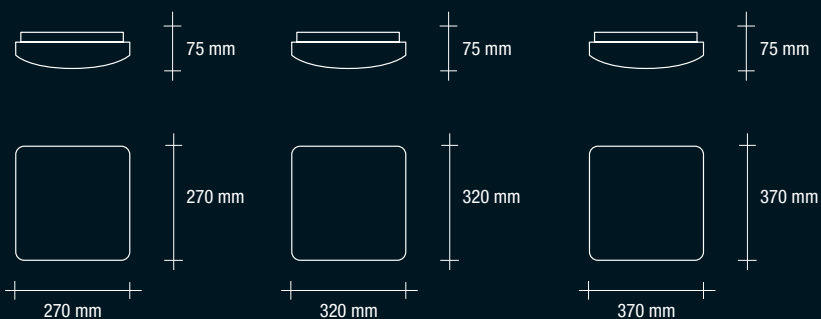

	VPL 03_14 3000K	VPL 03_20 3000K	VPL 03_28 3000K
articolo / item	● 3000 K 950 lumen	● 3000 K 1200 lumen	● 3000 K 1750 lumen
finitura / finished	bianco / white ■	bianco / white ■	bianco / white ■
voltaggio / voltage	AC 180-265V, 50Hz	AC 180-265V, 50Hz	AC 180-265V, 50Hz
driver	compreso / included	compreso / included	compreso / included
misure / measures	270 x 270 mm, H 75 mm	320 x 320 mm, H 75 mm	370 x 370 mm, H 75 mm
angolo / beam angle	120°	120°	120°
durata / life	30.000 ore / hours	30.000 ore / hours	30.000 ore / hours
materiale / material	Metallo + PMMA / Metal + PMMA	Metallo + PMMA / Metal + PMMA	Metallo + PMMA / Metal + PMMA
peso / weight	1,00 kg	0,77 kg	0,55 kg

14W  **IP20**



20W  **IP20**



28W  **IP20**





SPEEDY: plafoniera led in plastica, tonda, con finitura bianca.
SPEEDY: led ceiling light - round and white.

VPL 04

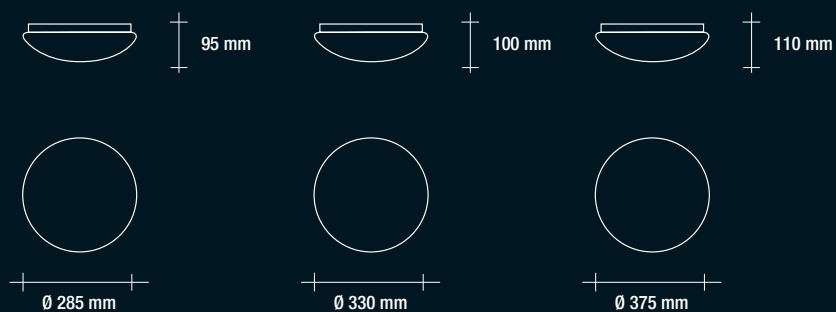

	VPL 04_14 3000K	VPL 04_20 3000K	VPL 04_28 3000K
articolo / item	● 3000 K 900 lumen	● 3000 K 1150 lumen	● 3000 K 1650 lumen
finitura / finished	bianco / white	bianco / white	bianco / white
voltaggio / voltage	AC 180-265V, 50Hz	AC 180-265V, 50Hz	AC 180-265V, 50Hz
driver	compreso / included	compreso / included	compreso / included
misure / measures	Ø 285 mm, H 95 mm	Ø 330 mm, H 100 mm	Ø 375 mm, H 110 mm
angolo / beam angle	120°	120°	120°
durata / life	30.000 ore / hours	30.000 ore / hours	30.000 ore / hours
materiale / material	Metallo + PMMA / Metal + PMMA	Metallo + PMMA / Metal + PMMA	Metallo + PMMA / Metal + PMMA
peso / weight	0,50 kg	0,70 kg	0,90 kg
	14W IP20 	20W IP20 	28W IP20



MOON: plafoniera tonda led con cornice e finitura bianca.
MOON: led ceiling light with white round frame.

VPL 05

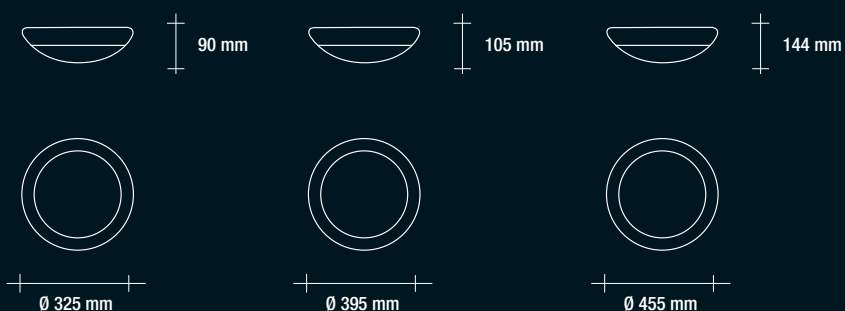



	VPL 05_18 3000K	VPL 05_24 3000K	VPL 05_30 3000K
articolo / item	● 3000 K 1200 lumen	● 3000 K 1650 lumen	● 3000 K 2000 lumen
finitura / finished	bianco / white	bianco / white	bianco / white
voltaggio / voltage	AC 100-265V, 50/60Hz	AC 100-265V, 50/60Hz	AC 100-265V, 50/60Hz
driver	compreso / included	compreso / included	compreso / included
misura / measures	Ø 325 mm, H 90 mm	Ø 395 mm, H 105 mm	Ø 455 mm, H 144 mm
angolo / beam angle	120°	120°	120°
durata / life	50.000 ore / hours	50.000 ore / hours	50.000 ore / hours
materiale / material	Metallo + PMMA / Metal + PMMA	Metallo + PMMA / Metal + PMMA	Metallo + PMMA / Metal + PMMA
peso / weight	1,33 kg	1,87 kg	2,34 kg
	18W IP20 	24W IP20 	30W IP20

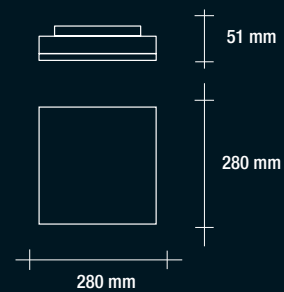
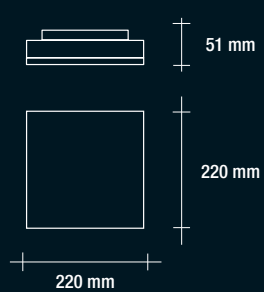

SHARK: plafoniera quadra led con finitura bianca.
SHARK: led ceillight light - squared and white.

VOD 58



	VOD 58_12 BI 3000K	VOD 58_18 BI 3000K
articolo / item	● 3000 K 800 lumen	● 3000 K 1200 lumen
finitura / finished	bianco / white 	bianco / white 
voltaggio / voltage	AC 220-240V, 50/60 Hz	AC 220-240V, 50/60 Hz
driver	compreso / included	compreso / included
misure / measures	220 x 220 mm, H 51 mm	280 x 280 mm, H 51 mm
angolo / beam angle	120°	120°
durata / life	30.000 ore / hours	30.000 ore / hours
materiale / material	PC	PC
peso / weight	0,61 kg	0,83 kg

12W  **IP40**



18W  **IP40**





JUPITER: cilindro bianco led a plafoniera con 3 anelli.
JUPITER: white led ceilinglight light with 3 ring.

VPL 06

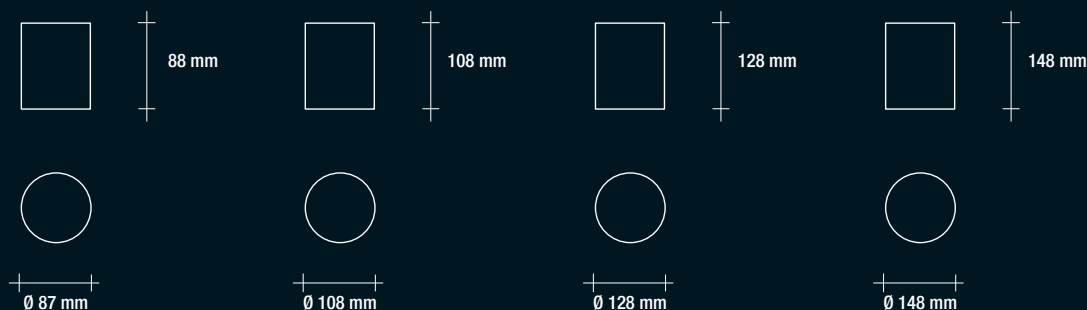

	VPL 06_10 BI 3000K	VPL 06_15 BI 3000K	VPL 06_20 BI 3000K	VPL 06_25 BI 3000K
articolo / item	● 3000 K 800 lumen	● 3000 K 1200 lumen	● 3000 K 1600 lumen	● 3000 K 2000 lumen
finitura / finished	bianco / white	bianco / white	bianco / white	bianco / white
voltaggio / voltage	AC 220-240V, 50/60Hz	AC 220-240V, 50/60Hz	AC 220-240V, 50/60Hz	AC 220-240V, 50/60Hz
driver	compreso / included	compreso / included	compreso / included	compreso / included
misure / measures	Ø 87 mm, H 88 mm	Ø 108 mm, H 108 mm	Ø 128 mm, H 128 mm	Ø 148 mm, H 148 mm
angolo / beam angle	100°	100°	100°	100°
durata / life	30.000 ore / hours	30.000 ore / hours	30.000 ore / hours	30.000 ore / hours
materiale / material	Alluminio+PMMA Aluminium+PMMA	Alluminio+PMMA Aluminium+PMMA	Alluminio+PMMA Aluminium+PMMA	Alluminio+PMMA Aluminium+PMMA
peso / weight	0,30 kg	0,50 kg	0,65 kg	1,00 kg

10W **IP20**



15W **IP20**



20W **IP20**



25W **IP20**





CUBE ROUND: plafoniera led a cilindro con finitura bianca.
CUBE ROUND: led ceiling light - cylinder and white.

VPL 07

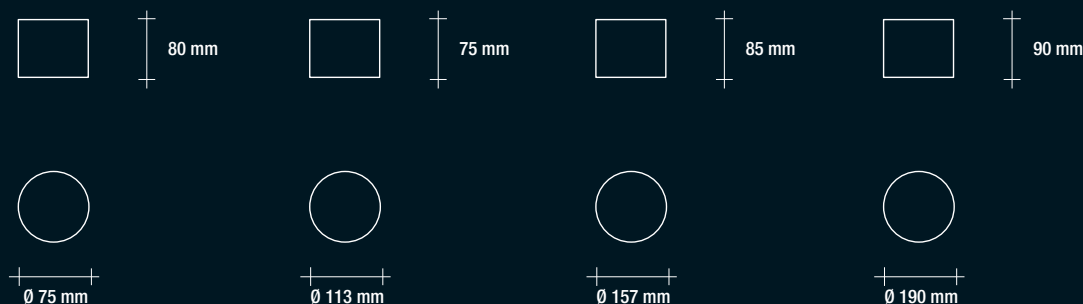









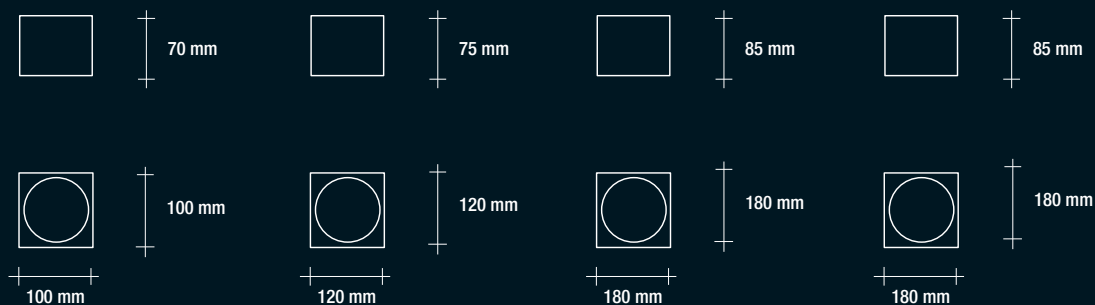

articolo / item	VPL 07_07 BI 3000K	VPL 07_12 BI 3000K	VPL 07_18 BI 3000K	VPL 07_30 BI 3000K
	● 3000 K 669 lumen	● 3000 K 1042 lumen	● 3000 K 1557 lumen	● 3000 K 2530 lumen
finitura / finished	bianco / white ■	bianco / white ■	bianco / white ■	bianco / white ■
voltaggio / voltage	AC 100-240V, 50/60Hz	AC 100-240V, 50/60Hz	AC 100-240V, 50/60Hz	AC 100-240V, 50/60Hz
driver	compreso / included	compreso / included	compreso / included	compreso / included
misure / measures	Ø 75 mm, H 80 mm	Ø 113 mm, H 75 mm	Ø 157 mm, H 85 mm	Ø 190 mm, H 90 mm
angolo / beam angle	150°	150°	150°	150°
durata / life	30.000 - 50.000 ore / hours	30.000 - 50.000 ore / hours	30.000 - 50.000 ore / hours	30.000 - 50.000 ore / hours
materiale / material	Alluminio / Aluminium	Alluminio / Aluminium	Alluminio / Aluminium	Alluminio / Aluminium
peso / weight	0,30 kg	0,60 kg	1,10 kg	1,50 kg
	7W  IP20 1 pz 20 pz	12W  IP20 1 pz 20 pz	18W  IP20 1 pz 10 pz	30W  IP20 1 pz 10 pz



CUBE SQUARE: plafoniera led a cubo con finitura bianca.
CUBE SQUARE: led ceiling light - squared and white.

VPL 08







articolo / item	VPL 08_07 BI 3000K	VPL 08_12 BI 3000K	VPL 08_18 BI 3000K	VPL 08_30 BI 3000K
	● 3000 K 669 lumen	● 3000 K 1040 lumen	● 3000 K 1557 lumen	● 3000 K 2466 lumen
finitura / finished	bianco / white ■	bianco / white ■	bianco / white ■	bianco / white ■
voltaggio / voltage	AC 100-240V, 50/60Hz	AC 100-240V, 50/60Hz	AC 100-240V, 50/60Hz	AC 100-240V, 50/60Hz
driver	compreso / included	compreso / included	compreso / included	compreso / included
misure / measures	100 x 100 mm, H 70 mm	120 x 120 mm, H 75 mm	180 x 180 mm, H 85 mm	180 x 180 mm, H 85 mm
angolo / beam angle	150°	150°	150°	150°
durata / life	30.000 - 50.000 ore / hours	30.000 - 50.000 ore / hours	30.000 - 50.000 ore / hours	30.000 - 50.000 ore / hours
materiale / material	Alluminio / Aluminium	Alluminio / Aluminium	Alluminio / Aluminium	Alluminio / Aluminium
peso / weight	0,40 kg	0,80 kg	1,40 kg	1,40 kg
	7W  IP20  	12W  IP20  	18W  IP20  	30W  IP20  

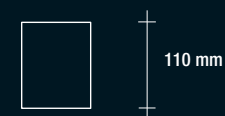

LOOK: cilindro bianco led a plafoniera, orientabile.
LOOK: led ceiling light - cylinder, orientable, white.

VPL 09



	VPL 09_07 BI 3000K	VPL 09_12 BI 3000K
articolo / item	● 3000 K 701 lumen	● 3000 K 1075 lumen
finitura / finished	bianco / white ■	bianco / white ■
voltaggio / voltage	AC 100-240V, 50/60Hz	AC 100-240V, 50/60Hz
driver	compreso / included	compreso / included
misure / measures	Ø 75 mm, H 110 mm	Ø 90 mm, H 120 mm
angolo / beam angle	36°	36°
durata / life	30.000 - 50.000 ore / hours	30.000 - 50.000 ore / hours
materiale / material	Alluminio / Aluminium	Alluminio / Aluminium
peso / weight	0,40 kg	0,60 kg
	7W  IP20  	12W  IP20  

LAMPAD E A SOSPENSIONE
PENDANT LED LIGHTS

BIANCO/WHITE

VSL 01_07 BI 3000K
VSL 01_12 BI 3000K
VSL 01_18 BI 3000K





PENDANT LED LIGHTS
SOSPENSIONE



SUSPENCE: sospensione cilindro led con finitura bianca.
SUSPENCE: pendant led light - cylinder and white.

VSL 01

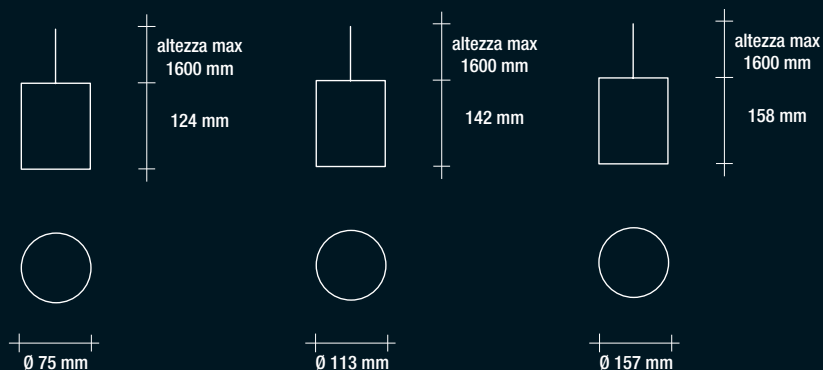

	VSL 01_07 BI 3000K	VSL 01_12 BI 3000K	VSL 01_18 BI 3000K
articolo / item	● 3000 K 669 lumen	● 3000 K 1040 lumen	● 3000 K 1556 lumen
finitura / finished	bianco / white ■	bianco / white ■	bianco / white ■
voltaggio / voltage	AC 100-240V, 50/60Hz	AC 100-240V, 50/60Hz	AC 100-240V, 50/60Hz
driver	compreso / included	compreso / included	compreso / included
misure / measures	Ø 75 mm, H 124 mm, max H 1600 mm	Ø 113 mm, H 142 mm, max H 1600 mm	Ø 157 mm, H 158 mm, max H 1600 mm
angolo / beam angle	150°	150°	150°
durata / life	30.000 - 50.000 ore / hours	30.000 - 50.000 ore / hours	30.000 - 50.000 ore / hours
materiale / material	Alluminio / Aluminium	Alluminio / Aluminium	Alluminio / Aluminium
peso / weight	0,50 kg	0,90 kg	1,50 kg



LAMPADE DA ESTERNO LED
LED GARDEN LIGHTS

BIANCO / WHITE

ANTRACITE / DARK GREY

VOD 50_10 BI 3000K
VOD 50_25 BI 3000K
VOD 50_30 BI 3000K

VOD 50_10 DG 3000K
VOD 50_25 DG 3000K
VOD 50_30 DG 3000K

VOD 51_10 BI 3000K
VOD 51_25 BI 3000K
VOD 51_30 BI 3000K

VOD 51_10 DG 3000K
VOD 51_25 DG 3000K
VOD 51_30 DG 3000K

VOD 52_04 BI 3000K
VOD 52_12 BI 3000K

VOD 52_04 DG 3000K
VOD 52_12 DG 3000K

VOD 53_06 BI 3000K

VOD 53_06 DG 3000K

VOD 54_03 BI 3000K

VOD 54_03 DG 3000K

VOD 55_03 BI 3000K

VOD 55_03 DG 3000K

VOD 56_08 BI 3000K

VOD 57_08 BI 3000K
VOD 57_12 BI 3000K

VOD 59_12 BI 3000K
VOD 59_18 BI 3000K

VOD 60_10 BI 3000K

VOD 62_10 BI 3000K
VOD 62_11 BI 3000K

VOD 60_10 DG 3000K

VOD 61_10 DG 3000K

VOD 64_10 BI 3000K

VOD 62_10 DG 3000K
VOD 62_11 DG 3000K

VOD 63_10 DG 3000K

VOD 64_10 DG 3000K

VOD 78_10 BI

VOD 76_10 DG
VOD 76_50 DG

VOD 79_10 BI
VOD 79_50 BI

VOD 77_10 DG

VOD 80_10 BI

VOD 78_10 DG

VOD 81_10 BI

VOD 79_10 DG
VOD 79_50 DG

VOD 80_10 DG

VOD 81_10 DG

NERO / BLACK

VOD 83_10 NE
VOD 83_20 NE

VOD 83_30 NE
VOD 83_50 NE





OUTDOOR
ESTERNO



SELENE: plafoniera tonda led da esterno con finitura bianca o antracite.
SELENE: led ceiling light for outdoor - round, white or dark grey

VOD 50

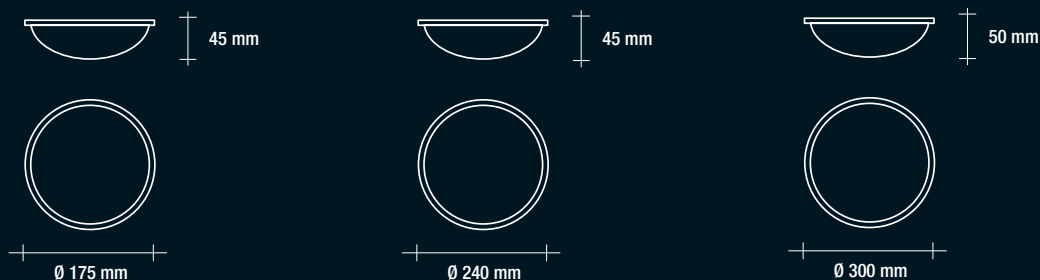

VOD 50_10 BI 3000K

- 3000 K
900 lumen

VOD 50_10 DG 3000K

- 3000 K
900 lumen

VOD 50_25 BI 3000K

- 3000 K
2300 lumen

VOD 50_25 DG 3000K

- 3000 K
2300 lumen

VOD 50_30 BI 3000K

- 3000 K
2800 lumen



VOD 50_30 DG 3000K



- 3000 K
2800 lumen

articolo / item

finitura / finished

bianco / white 
 antracite / dark grey 

bianco / white 
 antracite / dark grey 

bianco / white 
 antracite / dark grey 

voltaggio / voltage

AC 220-240V, 50/60 Hz

AC 220-240V, 50/60 Hz

AC 220-240V, 50/60 Hz

driver

compreso / included

compreso / included

compreso / included

misure / measures

Ø 175 mm, H 45 mm

Ø 240 mm, H 45 mm

Ø 300 mm, H 50 mm

angolo / beam angle

105°

105°

105°

durata / life

50.000 ore / hours

50.000 ore / hours

50.000 ore / hours

materiale / material

Alluminio + PC / Aluminium + PC

Alluminio + PC / Aluminium + PC

Alluminio + PC / Aluminium + PC

peso / weight

0,458 kg

0,813 kg

1,167 kg

10W  **IP54**

 1 pz  12 pz

25W  **IP54**

 1 pz  8 pz

30W  **IP54**

 1 pz  6 pz



SMART: plafoniera quadra led da esterno con finitura bianca o antracite.
SMART: led ceiling light for outdoor - squared, white or dark grey.

VOD 51

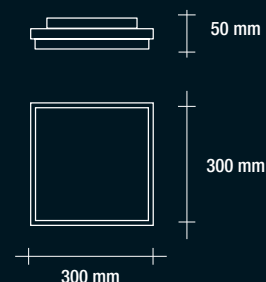
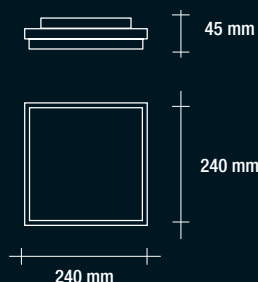
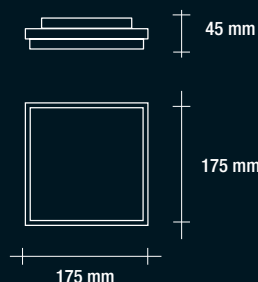
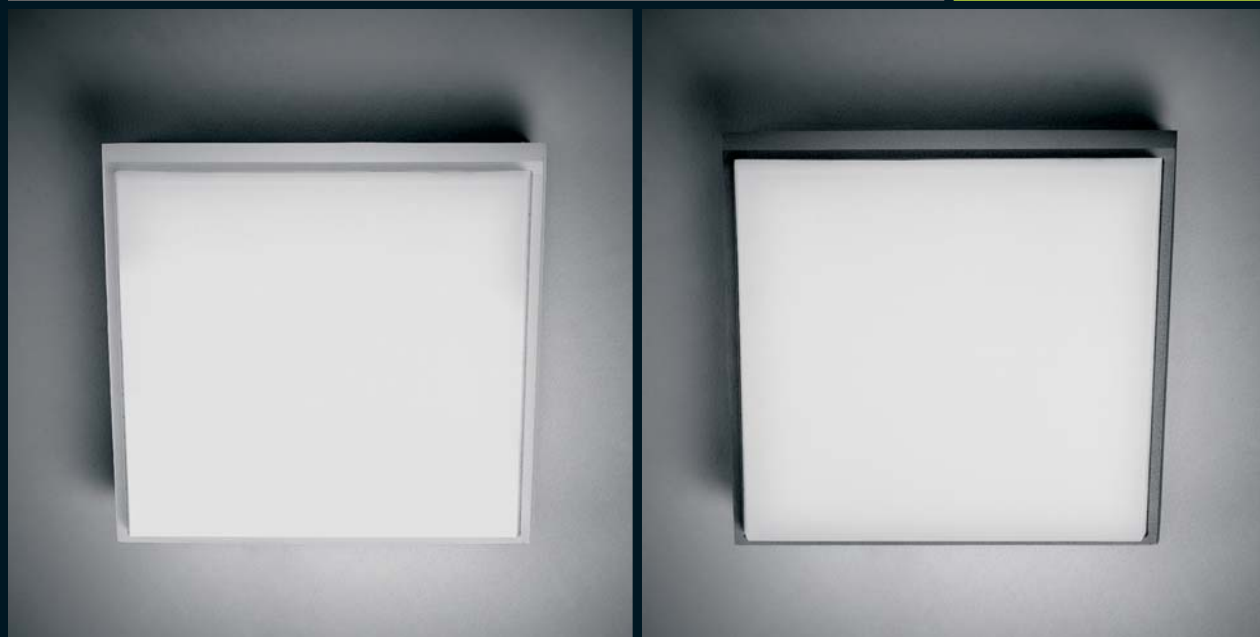

VOD 51_10 BI 3000K

- 3000 K
900 lumen

VOD 51_10 DG 3000K

- 3000 K
900 lumen

VOD 51_25 BI 3000K

- 3000 K
2300 lumen

VOD 51_25 DG 3000K

- 3000 K
2300 lumen

VOD 51_30 BI 3000K



- 3000 K
2800 lumen

VOD 51_30 DG 3000K

- 3000 K
2800 lumen

articolo / item

finitura / finished

bianco / white 
 antracite / dark grey 

bianco / white 
 antracite / dark grey 

bianco / white 
 antracite / dark grey 

voltaggio / voltage driver

AC 220-240V, 50/60 Hz
 compreso / included

AC 220-240V, 50/60 Hz
 compreso / included

AC 220-240V, 50/60 Hz
 compreso / included

misure / measures

175 x 175 mm, H 45 mm

240 x 240 mm, H 45 mm

300 x 300 mm, H 50 mm

angolo / beam angle

105°

105°

105°

durata / life

50.000 ore / hours

50.000 ore / hours

50.000 ore / hours

materiale / material

Alluminio + PC / Aluminium + PC

Alluminio + PC / Aluminium + PC

Alluminio + PC / Aluminium + PC

peso / weight

0,583 kg

1,00 kg

1,50 kg

10W  **IP54**



25W  **IP54**



30W  **IP54**









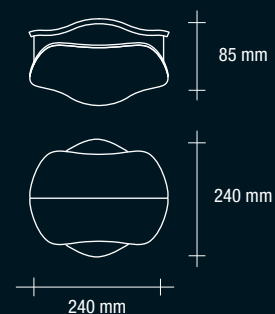
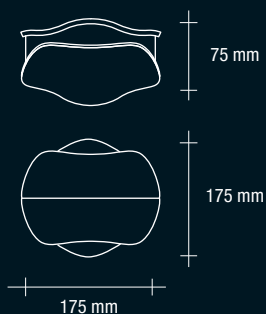

WAVE: applique / plafoniera led da esterno con finitura bianca o antracite.
WAVE: led ceilight light / applique for outdoor - white or dark grey.

VOD 52

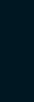

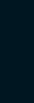
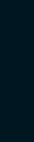
	<p>VOD 52_04 BI 3000K</p> <ul style="list-style-type: none"> ● 3000 K 350 lumen <p>VOD 52_04 DG 3000K</p> <ul style="list-style-type: none"> ● 3000 K 350 lumen 	<p>VOD 52_12 BI 3000K</p> <ul style="list-style-type: none"> ● 3000 K 850 lumen <p>VOD 52_12 DG 3000K</p> <ul style="list-style-type: none"> ● 3000 K 850 lumen
articolo / item		
finitura / finished	bianco / white  antracite / dark grey 	bianco / white  antracite / dark grey 
voltaggio / voltage	AC 220-240V, 50/60 Hz	AC 220-240V, 50/60 Hz
driver	compreso / included	compreso / included
misura / measures	175 x 175 mm, H 75 mm	240 x 240 mm, H 85 mm
durata / life	50.000 ore / hours	50.000 ore / hours
materiale / material	Alluminio + PC / Aluminium + PC	Alluminio + PC / Aluminium + PC
peso / weight	0,833 kg	1,50 kg
	<p>4W  IP54</p> <p> </p>	<p>12W  IP54</p> <p> </p>



LASER: applique led da esterno con doppio fascio di luce e finitura in bianco o antracite.
LASER: applique led for outdoor - double light (up and down), white or dark grey.

VOD 53

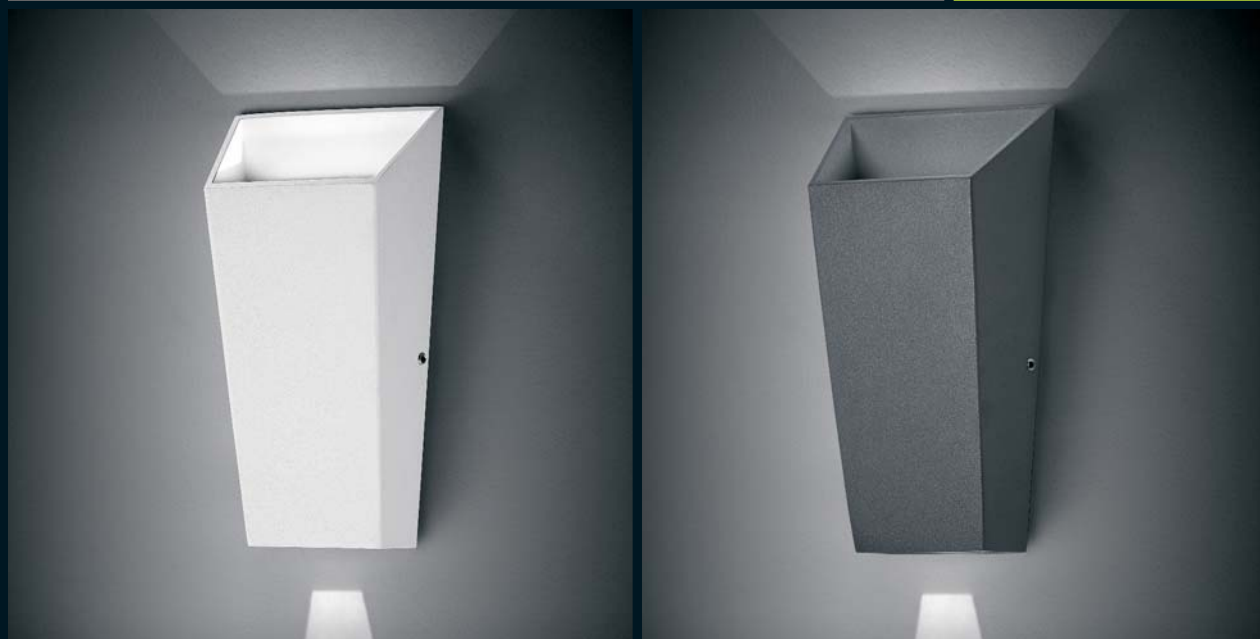

	VOD 53_06 BI 3000K	VOD 53_06 DG 3000K
articolo / item	● 3000 K 500 lumen	● 3000 K 500 lumen
finitura / finished	bianco / white 	antracite / dark grey
voltaggio / voltage	AC 220-240V, 50/60 Hz	AC 220-240V, 50/60 Hz
driver	compreso / included	compreso / included
misure / measures	65 mm x H 170 mm x 90 mm	65 mm x H 170 mm x 90 mm
durata / life	50.000 ore / hours	50.000 ore / hours
materiale / material	Alluminio / Aluminium	Alluminio / Aluminium
peso / weight	0,375 kg	0,375 kg

2x3W  IP54



2x3W  IP54





STEP ROUND: segnapassi led tondo da esterno con finitura bianca o antracite.
STEP ROUND: applique led for outdoor - round, white or dark grey.

VOD 54

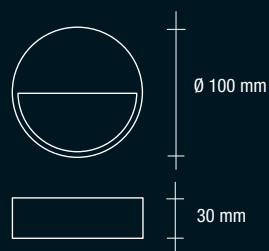

	VOD 54_03 BI 3000K	VOD 54_03 DG 3000K
articolo / item	● 3000 K 300 lumen	● 3000 K 300 lumen
finitura / finished	bianco / white 	antracite / dark grey
voltaggio / voltage	AC 220-240V, 50/60 Hz	AC 220-240V, 50/60 Hz
driver	compreso / included	compreso / included
misure / measures	Ø 100 mm, prof/depth 30 mm	Ø 100 mm, prof/depth 30 mm
durata / life	50.000 ore / hours	50.000 ore / hours
materiale / material	Alluminio / Aluminium	Alluminio / Aluminium
peso / weight	0,21 kg	0,21 kg

3W  **IP54**



3W  **IP54**





STEP SQUARE: segnapassi led quadro da esterno con finitura bianca o antracite.
STEP SQUARE: applique led for outdoor - squared, white or dark grey.

VOD 55

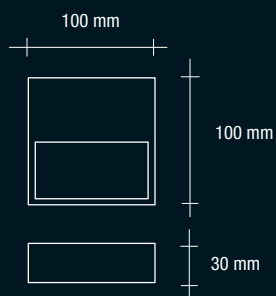

	VOD 55_03 BI 3000K	VOD 55_03 DG 3000K
articolo / item	● 3000 K 300 lumen	● 3000 K 300 lumen
finitura / finished	bianco / white 	antracite / dark grey
voltaggio / voltage	AC 220-240V, 50/60 Hz	AC 220-240V, 50/60 Hz
driver	compreso / included	compreso / included
misure / measures	100 x 100 mm, prof/depth 30 mm	100 x 100 mm, prof/depth 30 mm
durata / life	50.000 ore / hours	50.000 ore / hours
materiale / material	Alluminio / Aluminium	Alluminio / Aluminium
peso / weight	0,25 kg	0,25 kg

3W  **IP54**

1 pz 30 pz

3W  **IP54**

1 pz 30 pz



HOLLY: plafoniera ovale led da esterno con finitura bianca.

HOLLY: led ceiling light for outdoor - oval, white.

VOD 56

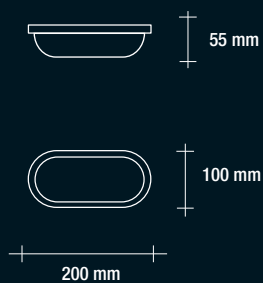

articolo / item	VOD 56_08 BI 3000K ● 3000 K 550 lumen
finitura / finished	bianco / white 
voltaggio / voltage	AC 220-240V, 50/60 Hz
driver	compreso / included
misure / measures	200 x 100 mm, H 55 mm
angolo / beam angle	120°
durata / life	30.000 ore / hours
materiale / material	PC
peso / weight	0,28 kg

8W  IP54

1 pz

16 pz



DOUBLE: plafoniera tonda led da esterno con bordo. Finitura bianca.
DOUBLE: led ceiling light with frame, for outdoor, round, white.

VOD 57

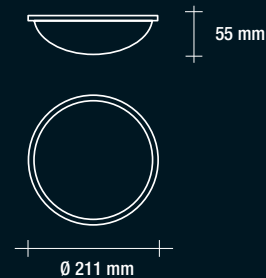
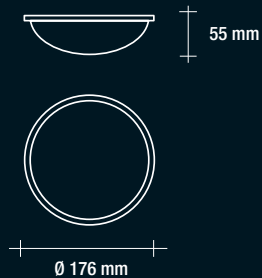

	VOD 57_08 BI 3000K	VOD 57_12 BI 3000K
articolo / item	● 3000 K 550 lumen	● 3000 K 850 lumen
finitura / finished	bianco / white 	bianco / white
voltaggio / voltage	AC 220-240V, 50/60 Hz	AC 220-240V, 50/60 Hz
driver	compreso / included	compreso / included
misura / measures	Ø 176 mm, H 55 mm	Ø 211 mm, H 55 mm
angolo / beam angle	120°	120°
durata / life	30.000 ore / hours	30.000 ore / hours
materiale / material	PC	PC
peso / weight	0,30 kg	0,40 kg

8W  **IP54**



12W  **IP54**





WHALE: plafoniera tonda led da esterno con finitura bianca.

WHALE: led ceiling light for outdoor - round, white.

VOD 59



62 mm









62 mm



∅ 220 mm



∅ 280 mm

	VOD 59_12 BI 3000K	VOD 59_18 BI 3000K
articolo / item	● 3000 K 800 lumen	● 3000 K 1200 lumen
finitura / finished	bianco / white ■	bianco / white ■
voltaggio / voltage	AC 220-240V, 50/60 Hz	AC 220-240V, 50/60 Hz
driver	compreso / included	compreso / included
misure / measures	∅ 220 mm, H 62 mm	∅ 280 mm, H 62 mm
angolo / beam angle	120°	120°
durata / life	25.000 ore / hours	25.000 ore / hours
materiale / material	PC	PC
peso / weight	0,40 kg	0,62 kg
	12W  IP44  1 pz  10 pz	18W  IP44  1 pz  10 pz



IRIDE: applique led a cubo da esterno, flussoregolabile, con finitura bianca o antracite.
IRIDE: led garden light - applique cube, adjustable light beam, white or dark grey.

VOD 60

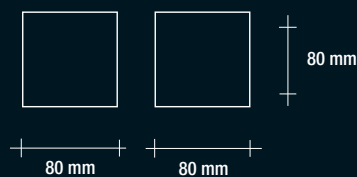

	VOD 60_10 BI	VOD 60_10 DG
articolo / item	● 3000 K 127 lumen	● 3000 K 127 lumen
finitura / finished	bianco / white 	antracite / dark grey
voltaggio / voltage	AC 220-240V, 50/60 Hz	AC 220-240V, 50/60 Hz
driver	compreso / included	compreso / included
misure / measures	80 x 80 mm, H 80 mm	80 x 80 mm, H 80 mm
angolo / beam angle	regolabile / adjustable	regolabile / adjustable
durata / life	30.000 ore / hours	30.000 ore / hours
materiale / material	Alluminio / Aluminium	Alluminio / Aluminium
peso / weight	0,393 kg	0,393 kg

2x3W  **IP54**



2x3W  **IP54**





KAORI: applique led rettangolare da esterno con finitura antracite.

KAORI: led garden light - rectangular applique, dark grey.

VOD 61

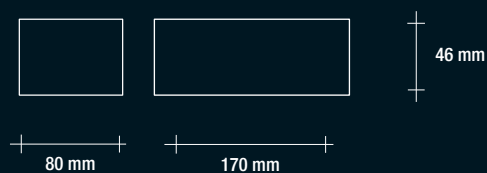

articolo / item

finitura / finished

voltaggio / voltage

misure / measures

angolo / beam angle

durata / life

materiale / material

peso / weight

VOD 61_10 DG

- 3000 K
398 lumen

antracite / dark grey

AC 220-240V, 50/60 Hz

170 x 80 mm, H 46 mm

110°

30.000 ore / hours

ABS & PC

0,288 kg

8W  **IP65**

1 pz

20 pz



CLOE: applique led orizzontale da esterno, slim, angoli arrotondati, con finitura bianca o antracite.
CLOE: led garden light - horizontal applique, slim, round borders, white or dark grey.

VOD 62

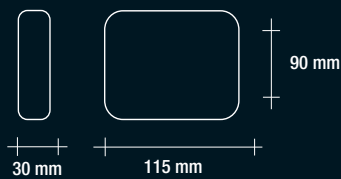
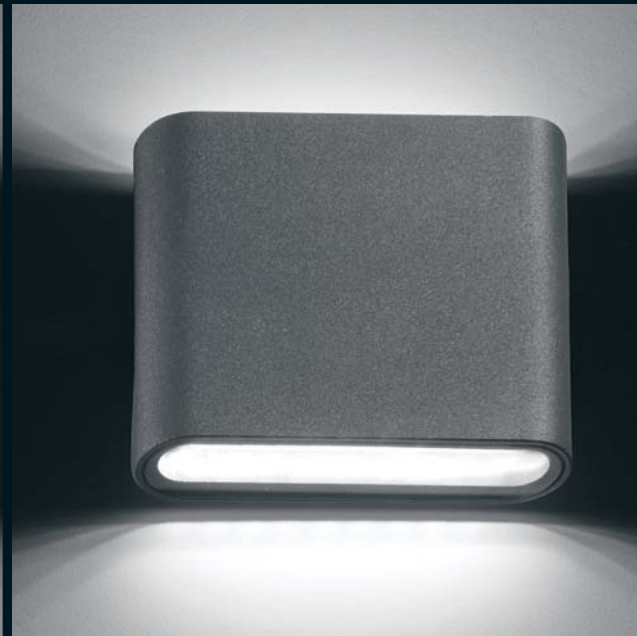

articolo / item	VOD 62_10 BI <ul style="list-style-type: none"> ● 3000 K 505 lumen VOD 62_10 DG <ul style="list-style-type: none"> ● 3000 K 505 lumen 	VOD 62_11 BI <ul style="list-style-type: none"> ● 3000 K 776 lumen VOD 62_11 DG <ul style="list-style-type: none"> ● 3000 K 776 lumen
finitura / finished	bianco / white  antracite / dark grey 	bianco / white  antracite / dark grey 
voltaggio / voltage	AC 220-240V, 50/60 Hz	AC 220-240V, 50/60 Hz
driver	compreso / included	compreso / included
misura / measures	115 x 30 mm, H 90 mm	175 x 30 mm, H 90 mm
angolo / beam angle	120°	120°
durata / life	30.000 ore / hours	30.000 ore / hours
materiale / material	Alluminio / Aluminium	Alluminio / Aluminium
peso / weight	0,411 kg	0,550 kg

6W  **IP54**



12W  **IP54**





DAFNE: applique led verticale da esterno, flussoregolabile, con finitura antracite.

DAFNE: led garden light - vertical applique, adjustable lamp head, dark grey.

VOD 63

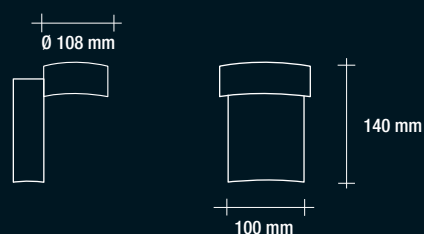

articolo / item

finitura / finished

voltaggio / voltage

driver

misure / measures

angolo / beam angle

durata / life

materiale / material

peso / weight

VOD 63_10 DG

- 3000 K
925 lumen

antracite / dark grey

AC 220-240V, 50/60 Hz

compreso / included

Ø 108 mm, 100 mm x H 140 mm

150°

30.000 ore / hours

Alluminio / Aluminium

0,491 kg

10W  IP54

1 pz



12 pz

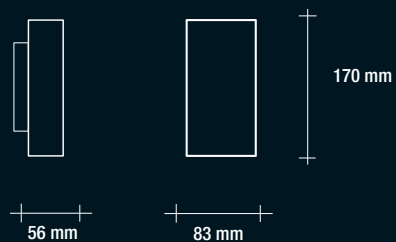
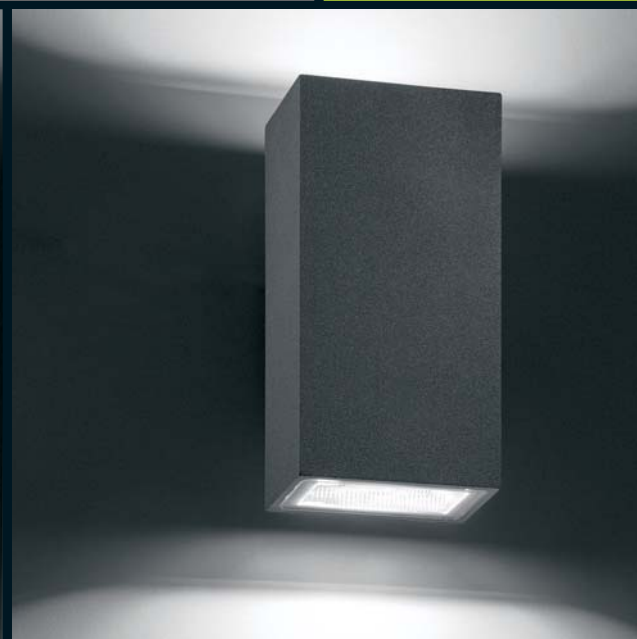

CLIZIA: applique COB led rettangolare slim, verticale, da esterno, con finitura bianca o antracite.
CLIZIA: led garden light - COB, rectangular applique, slim, vertical, white or dark grey.

VOD 64



	VOD 64_10 BI	VOD 64_10 DG
articolo / item	● 3000 K 674 lumen	● 3000 K 674 lumen
finitura / finished	bianco / white 	antracite / dark grey
voltaggio / voltage	AC 220-240V, 50/60 Hz	AC 220-240V, 50/60 Hz
driver	compreso / included	compreso / included
misure / measures	83 x 56mm, H 170 mm	83 x 56mm, H 170 mm
angolo / beam angle	160°	160°
durata / life	30.000 ore / hours	30.000 ore / hours
materiale / material	Alluminio / Aluminium	Alluminio / Aluminium
peso / weight	0,706 kg	0,706 kg
	2x5W  IP54 1 pz 12 pz	2x5W  IP54 1 pz 12 pz



SUNFLOWER: applique curva verticale led da esterno con finitura in antracite.
SUNFLOWER: led garden light - curved applique, dark grey.

VOD 76

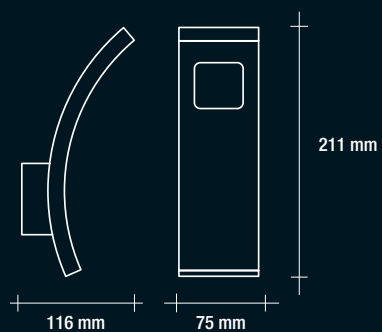

articolo / item

VOD 76_10 DG

- 4000 K
- 550 lumen

finitura / finished	antracite / dark grey 
voltaggio / voltage	AC 220-240V, 50/60 Hz
driver	compreso / included
misure / measures	75 x H 211 mm, prof/depth 116 mm
angolo / beam angle	95°
durata / life	20.000 ore / hours
materiale / material	Alluminio + PC / Aluminium + PC
peso / weight	0,36 kg

7,5W  IP54

1 pz

4 pz



SUNFLOWER: paletto curvo led da esterno in antracite.
SUNFLOWER: led garden light - curved floor lamp, dark grey.

VOD 76

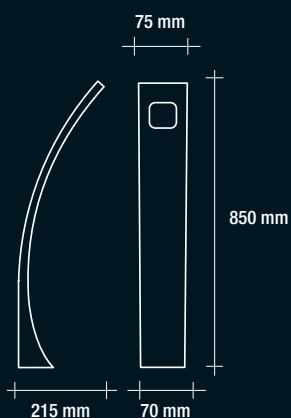

articolo / item

VOD 76_50 DG

- 4000 K
550 lumen

finitura / finished	antracite / dark grey
voltaggio / voltage	AC 220-240V, 50/60 Hz
driver	compreso / included
misure / measures	75 x H 850 mm, prof/depth 215 mm, base 70 mm
angolo / beam angle	95°
durata / life	20.000 ore / hours
materiale / material	Alluminio + PC / Aluminium + PC
peso / weight	1,01 kg

7,5W  IP54





SMILE: applique led a mezzaluna da esterno con finitura in antracite.
SMILE: led garden light - curved and horizontal applique, dark grey.

VOD 77

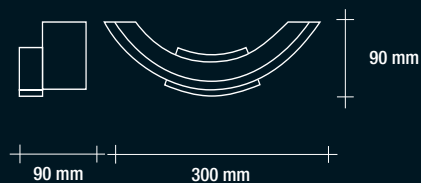

articolo / item

VOD 77_10 DG

- 4000 K
- 600 lumen

finitura / finished

antracite / dark grey 

voltaggio / voltage

AC 220-240V, 50/60 Hz

driver

compreso / included

misura / measures

300 x H 90 mm, prof/depth 90 mm

durata / life

20.000 ore / hours

materiale / material

Alluminio + PC / Aluminium + PC

peso / weight

0,60 kg

8,5W  IP54

1 pz

6 pz



UP&DOWN: applique orizzontale a led da esterno con finitura bianca o antracite.
UP&DOWN: led garden light - rectangular and horizontal applique, white or dark grey.

VOD 78

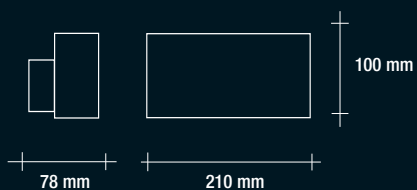

	VOD 78_10 BI	VOD 78_10 DG
articolo / item	● 4000 K 600 lumen	● 4000 K 600 lumen
finitura / finished	bianco / white 	antracite / dark grey
voltaggio / voltage	AC 220-240V, 50/60 Hz	AC 220-240V, 50/60 Hz
driver	compreso / included	compreso / included
misure / measures	210 x H 100 mm, prof/depth 78 mm	210 x H 100 mm, prof/depth 78 mm
durata / life	20.000 ore / hours	20.000 ore / hours
materiale / material	Alluminio + PC / Aluminium + PC	Alluminio + PC / Aluminium + PC
peso / weight	0,83 kg	0,83 kg

9W  **IP54**

1 pz 12 pz

9W  **IP54**

1 pz 12 pz



SKYLINE: applique led rettangolare da esterno con finitura bianca o antracite.
SKYLINE: led garden light - rectangular applique, white or dark grey.

VOD 79

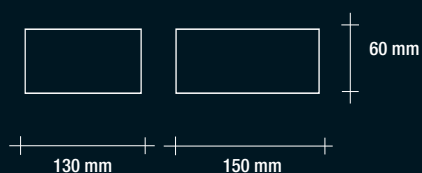

	VOD 79_10 BI	VOD 79_10 DG
articolo / item	● 4000 K 500 lumen	● 4000 K 500 lumen
finitura / finished	bianco / white 	antracite / dark grey
voltaggio / voltage	AC 220-240V, 50/60 Hz	AC 220-240V, 50/60 Hz
driver	compreso / included	compreso / included
misure / measures	150 x H 60 mm, prof/depth 130 mm	150 x H 60 mm, prof/depth 130 mm
durata / life	20.000 ore / hours	20.000 ore / hours
materiale / material	Alluminio + PC / Aluminium + PC	Alluminio + PC / Aluminium + PC
peso / weight	0,54 kg	0,54 kg

8W  **IP54**



8W  **IP54**





SKYLINE: paletto rettangolare led da esterno con finitura bianca o antracite.
SKYLINE: led garden light - rectangular floor lamp, white or dark grey.

VOD 79

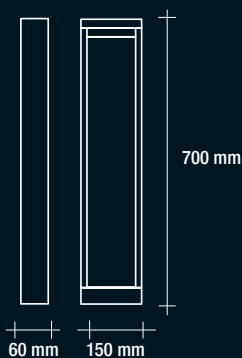
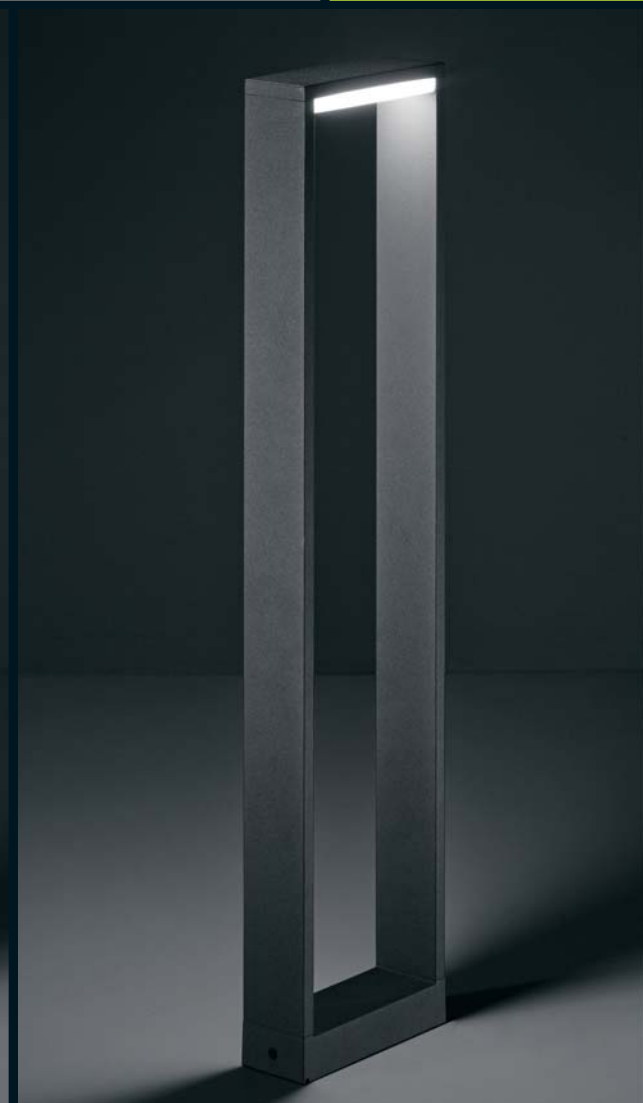
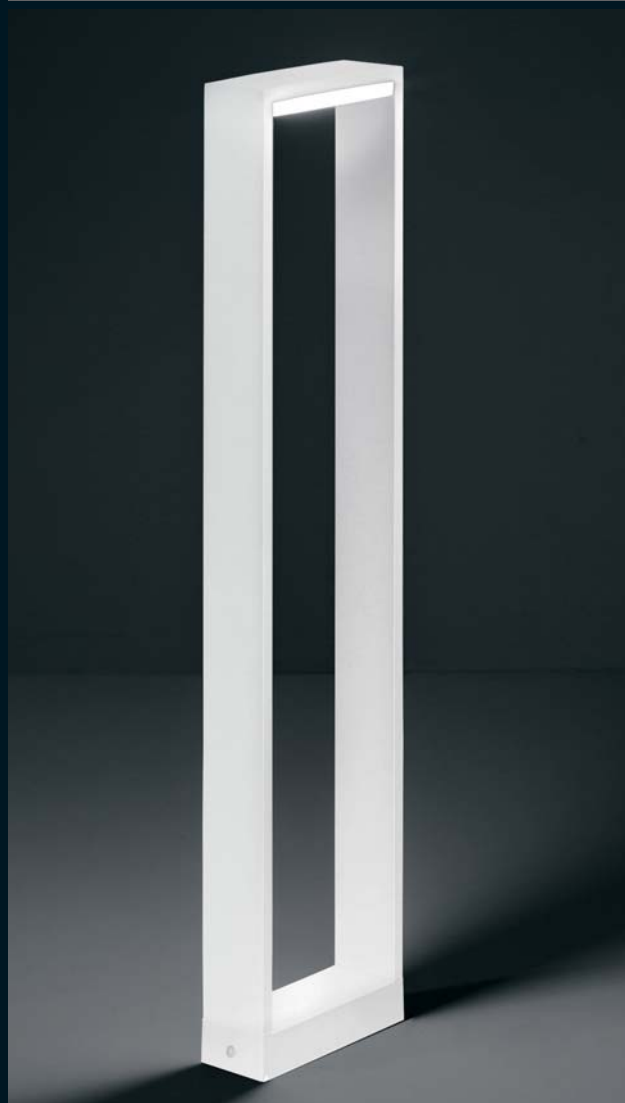

	VOD 79_50 BI	VOD 79_50 DG
articolo / item	● 4000 K 500 lumen	● 4000 K 500 lumen
finitura / finished	bianco / white 	antracite / dark grey
voltaggio / voltage	AC 220-240V, 50/60 Hz	AC 220-240V, 50/60 Hz
driver	compreso / included	compreso / included
misure / measures	150 x H 700 mm, prof/depth 60 mm	150 x H 700 mm, prof/depth 60 mm
durata / life	20.000 ore / hours	20.000 ore / hours
materiale / material	Alluminio + PC / Aluminium + PC	Alluminio + PC / Aluminium + PC
peso / weight	1,38 kg	1,38 kg

8W  IP54

1 pz 6 pz

8W  IP54

1 pz 6 pz



TENDER: applique cubo led da esterno con finitura bianca o antracite.
TENDER: led garden light - applique cube, white or dark grey.

VOD 80

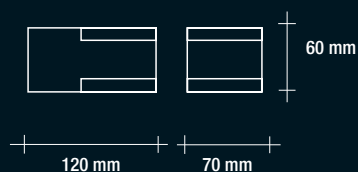
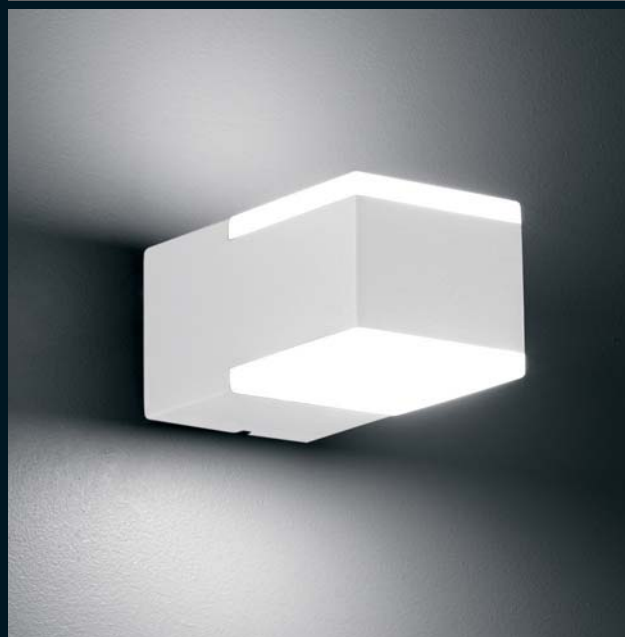

	VOD 80_10 BI	VOD 80_10 DG
articolo / item	● 4000 K 550 lumen	● 4000 K 550 lumen
finitura / finished	bianco / white 	antracite / dark grey
voltaggio / voltage	AC 220-240V, 50/60 Hz	AC 220-240V, 50/60 Hz
driver	compreso / included	compreso / included
misure / measures	70 x H 60 mm, prof/depth 120 mm	70 x H 60 mm, prof/depth 120 mm
durata / life	20.000 ore / hours	20.000 ore / hours
materiale / material	Alluminio + HIPP / Aluminium + HIPP	Alluminio + HIPP / Aluminium + HIPP
peso / weight	0,42 kg	0,42 kg

9W  **IP54**



9W  **IP54**





ELLE: applique 90° led da esterno con finitura bianca o antracite.
 ELLE: led garden light - applique with a a mould of 90°, white or dark grey.

VOD 81

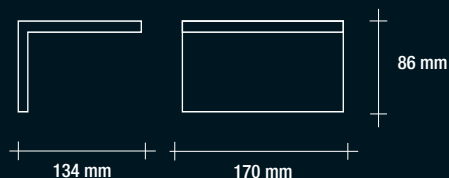

	VOD 81_10 BI	VOD 81_10 DG
articolo / item	● 4000 K 750 lumen	● 4000 K 750 lumen
finitura / finished	bianco / white 	antracite / dark grey
voltaggio / voltage	AC 100-240V, 50/60 Hz	AC 100-240V, 50/60 Hz
driver	compreso / included	compreso / included
misure / measures	170 x H 86 mm, prof/depth 134 mm	170 x H 86 mm, prof/depth 134 mm
angolo / beam angle	95°	95°
durata / life	20.000 ore / hours	20.000 ore / hours
materiale / material	Alluminio + PC / Aluminium + PC	Alluminio + PC / Aluminium + PC
peso / weight	0,57 kg	0,57 kg

10W  IP54



10W  IP54





FLOOD: applique led da esterno IP65 con finitura in nero.
FLOOD: led flood light for outdoor, IP65, black.

VOD 83



Altezza max d'installazione / Max installation height = 4 mt

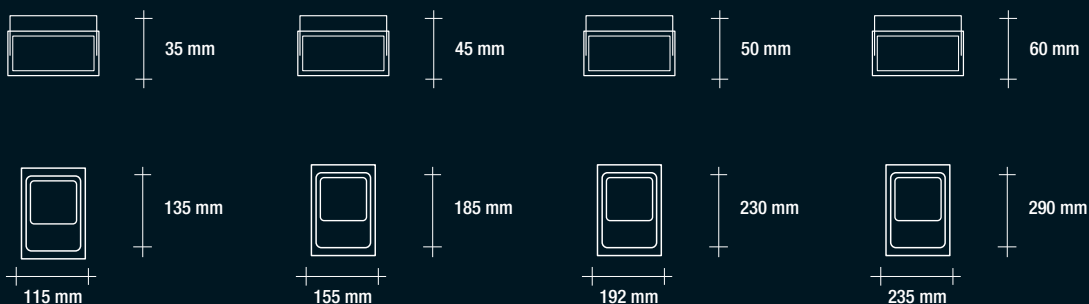

articolo / item	VOD 83_10 NE	VOD 83_20 NE	VOD 83_30 NE	VOD 83_50 NE
	● 4000K 508 lumen	● 4000K 1319 lumen	● 4000K 2196 lumen	● 4000K 3336 lumen
finitura / finished	nero / black <input type="checkbox"/>	nero / black <input type="checkbox"/>	nero / black <input type="checkbox"/>	nero / black <input type="checkbox"/>
voltaggio / voltage	AC 220-240V, 50/60 Hz	AC 220-240V, 50/60 Hz	AC 220-240V, 50/60 Hz	AC 220-240V, 50/60 Hz
driver	compreso / included	compreso / included	compreso / included	compreso / included
misure / measures	115 x H 135 mm, prof/depth 35 mm	155 x H 185 mm, prof/depth 45 mm	192 x H 230 mm, prof/depth 50 mm	235 x H 290 mm, prof/depth 60 mm
angolo / beam angle	120°	120°	120°	120°
durata / life	50.000 ore / hours	50.000 ore / hours	50.000 ore / hours	50.000 ore / hours
materiale / material	Alluminio / Aluminium	Alluminio / Aluminium	Alluminio / Aluminium	Alluminio / Aluminium
peso / weight	0,40 kg	0,80 kg	1,21 kg	1,71 kg
	10W IP65 	20W IP65 	30W IP65 	50W IP65

VIVIDA
TECHNOLOGY

concept: www.red-apple.it
art: paola rudoni
product photo: paolo volontà

VIVIDA
TECHNOLOGY

Vivida srl - Viale dell'Industria 10
20037 Paderno Dugnano (Mi) - Italy
P +39 02 91082343
F +39 02 91843359
info@vivaluce.com