

ATHENA
così in luce

 **ATHENA**
così in luce



La nostra azienda, presente sul mercato dal 1972 concentra nella propria sede tutte le fasi di lavorazione dei prodotti, dalla progettazione alla costruzione e all'assemblaggio.

La massima professionalità viene impiegata nella creazione e nella produzione dei nostri articoli per garantirne la più accurata qualità e la massima sicurezza. Seguendo tale impegno tutti i nostri prodotti hanno raggiunto la marcatura europea CE attestante la conformità alle norme di sicurezza. Da sempre a fianco della clientela per offrire la massima disponibilità e professionalità ad aiutare a risolvere ogni problematica in campo illuminotecnico e esecuzioni speciali o contract.

Collezioni di lampade da terra, lampade da parete, plafoniere, sospensioni e lampade da tavolo, sistemi su cavo a 220V e 12V. I nuovi sistemi e faretto a incasso a LED completano la gamma della produzione, che arreda ambienti sia moderni che in stile. L'evoluzione della nuova tecnologia LED si concretizza nella produzione di nuove collezioni e nei nuovi sistemi con sorgenti luminose a LED. L'esperienza dei nostri tecnici e designer, la ricerca di nuovi materiali, l'utilizzo delle nuove tecnologie di costruzione caratterizzano l'unicità delle nostre collezioni.

Nella ricerca costante della migliore funzionalità e qualità dei nostri prodotti, si riserva in qualsiasi momento la facoltà di apportare modifiche e migliorie sugli stessi senza alcun obbligo di avviso alla Clientela.

Our firm, on the market since 1972 converges all the manufacturing cycle of its production, from the design to the production and assembly, in its factory.

Great professionalism is used in the creation and production of our products to guarantee top quality and maximum safety.

Following that course, all our products have obtained the European EC mark, certifying their compliance with safety regulations. Always working alongside customers to offer maximum availability and professionalism, helping them find solutions to any problem that may arise in the field of lighting, for special executions or contracts.

Collections of floor lamps, wall lights, ceiling light fixtures, pendants and table lamps that furnish both modern and classical surroundings. Evolution of the new led technology has led to the creation of new collections and new systems using led light sources.

The experience of our technicians and designers, the search for new materials, the use of new manufacturing technologies characterize the unicity of our collections.

In the continuous engagement to improve the performance and quality of our products, we reserve the right to make modifications and improvements to them without prior notice to our Customers.

PROFILI

OMICRON	12
SIGMA	26
OMEGA	36
DELTA	42
TAU	48
SIHON	54
B-LIGHT	62
MICRO	64
VELA	68
KAPPA	70
PIATTO	71
RESINATI IP67	72
ETHA	76
STRIP FLEX	78

SISTEMI

FOCUS 300	90
FOCUS 160	102
TWIN	110

DECORATIVO

BRIDGE	136
SWING	140
LIBRO	142
MODÌ	145
OMICRON	146
INCROCIO	154
EDERA	164
DADAJE	172
GIOTTO	180
DEGAS	190
MONET	200
PICASSO	206
RIFLESSI	210
KITE	212
MILO	214
BETA	218
ARTE	220
FARETTI	221

INCASSO

ORIONE	227
PEGASO	239

ACCESSORI

DRIVERS	244
CENTRALINE	248
LAMPADINE	251







Simboli e marchi

Symbols and marks

-  **I prodotti sono conformi alle normative EMC**
The product comply with EEC directives.
La marcatura CE garantisce la libera circolazione dei prodotti sul mercato europeo.
EEC marking guarantees the free circulation of the products in the European market.
-  **Apparecchi dotati di morsetto di terra o cavo completo di conduttore di terra.**
Equipment with metal parts connected to the earth circuit.
-  **Apparecchi dotati di doppio isolamento e senza dispositivi di messa a terra.**
Equipment with double insulation and without earthing devices.
-  **Apparecchi alimentati con tensione inferiore a 50V.**
Equipment powered with safety voltage lower than 50V.
-  **Apparecchi idonei per essere installati su superfici infiammabili.**
Equipment can be used on inflammable surfaces.
-  **Dimensione del foro di incasso**
Hole dimensions
-  **Peso netto in gr. del prodotto**
Net weight in gr. of the product
-  **Calpestabile**
Walkable
-  **Apparecchio completo di driver**
Device completed with the driver
-  **Apparecchio non fornito di driver**
Device without the driver
-  **Apparecchio completo di dimmer**
Device completed with the dimmer
-  **Dimmer a richiesta**
Dimmer available under request
-  **Durata del prodotto**
Duration of the product
-  **Temperatura**
Temperature
-  **Misura di taglio**
Cutting size
-  **Apparecchio con luce rivolta verso il basso**
Device with the light pointing downward
-  **Apparecchio con luce rivolta verso l'alto**
Device with the light pointing upward
-  **Apparecchio con luce rivolta verso l'alto e il basso**
Device with the light pointing upward and downward
-  **Uso interno parete/soffitto**
Indoor wall/ceiling
-  **Uso interno ed esterno parete/soffitto**
Indoor and outdoor wall/ceiling

Indice protezione IP ...**Resistenza alla penetrazione di solidi (1^ cifra) e liquidi (2^ cifra)**

Protective degree IP ... Resistance of the fitting to the penetration of solid and liquids

- IP 1..  **Protetto contro la penetrazione di corpi solidi di dimensione superiore a 50 mm.**
Protected against penetration of solids larger than 50 mm.
- IP 2..  **Protetto contro la penetrazione di corpi solidi di dimensione superiore a 12 mm.**
Protected against penetration of solids larger than 12 mm.
- IP 3.. **Protetto contro la penetrazione di corpi solidi di dimensione superiore a 2,5 mm.**
Protected against penetration of solids larger than 2,5 mm.
- IP 4.. **Protetto contro la penetrazione di corpi solidi di dimensione superiore a 1 mm.**
Protected against penetration of solids larger than 1 mm.
- IP 5.. **Protetto contro la penetrazione della polvere**
Protected against penetration of dust
- IP 6.. **Protetto completamente contro la penetrazione della polvere**
Completely protected against penetration of dust
- IP ..0 **Non protetto / Unprotected**
- IP ..1 **Protetto contro le cadute verticali di gocce d'acqua**
Protected against vertical falling of water drops
- IP ..2 **Protetto contro la caduta d'acqua con inclinazione max di 15°**
Protected against falling of water with 15° maximum angle
- IP ..3  **Protetto contro la pioggia / Protected against rain**
- IP ..4  **Protetto contro gli spruzzi / Protected against sprinklings**
- IP ..5  **Protetto contro i getti d'acqua / Protected against water jets**
- IP ..6 **Protetto contro le ondate / Protected against heavy waves**
- IP ..7  **Protetto contro l'immersione temporanea**
Protected against temporary immersion

Sezione catalogo

INCASSO | ORIONE

227

Nome collezione

ORIONE

Design Athena

Descrizione prodotto

Faretto da incasso fisso per interno con corpo in ottone. Completo di molle per installazione.
Indoor fixed recessed metal spot light. Copper structure. Springs included.

Foto prodotto

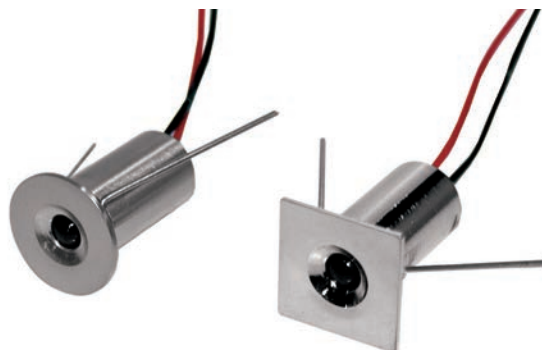

Collegamento in parallelo.
Parallel connection.

Caratteristiche tecniche prodotto

FARETTO INCASSO TONDO LED 1x0,5W - 24Vdc 20mA

Codice prodotto, finiture, led

Code	Color	Led	Optic
11301	1 Chrome	1 Natural White	120°
	2 Nickel	6 Warm White	
	5 White	2 Blue	
		4 Green	
		8 Red	
		9 RGB	

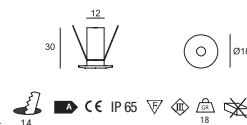

Marchi e simboli

FARETTO INCASSO QUADRO LED 1x0,5W - 24Vdc 20mA

Code	Color	Led	Optic
11311	1 Chrome	1 Natural White	120°
	2 Nickel	6 Warm White	
	5 White	2 Blue	
		4 Green	
		8 Red	
		9 RGB	

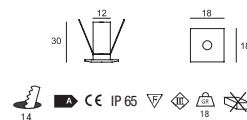

Accessori

DRIVERS

Utilizzare alimentatori 24Vdc da pag
Use DRIVERS 24Vdc from page

ACCESSORI

1130
Cassaforma + OR
Mould + OR
Ø 16x35

**COMPOSIZIONE CODICE PRODOTTO - da utilizzare in fase d'ordine**

APPLIQUE LED ORIENTABILE
Sorgente Led 1x12W - 220/240v dimmerabile

Code	Color	Led	Polycarbonate
5701	5 White	1 4000°K 1210 lm	1 Trasparent
		6 2800°K 1000 lm	7 Orange
			8 Red

Codice: **5601.5.6.7** applique bianca - warm white - polycarb. arancio

PROFILI E STRIP | PROFILES AND STRIP LED

PROFILI LED | LED PROFILES



ETHA 76

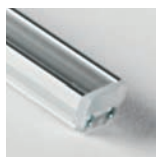

DELTA 43



OMICRON 13

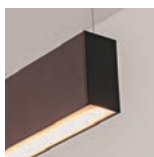

OMICRON 20



OMEGA WET 37



MICR 65



RESINATI 72



SIGMA 27

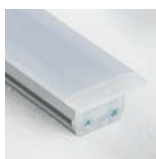

SIHON 55

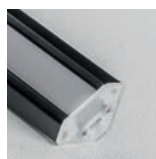

TAU 49

PROFILI | PROFILES

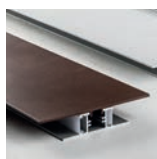

B-LIGHT 62

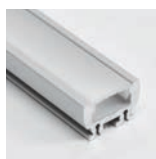

DELTA 46

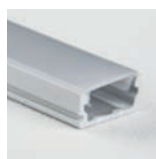

MICRO 66



KAPPA 70



OMEGA 40

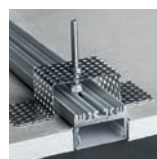

SIGMA 3 30



SIGMA 32

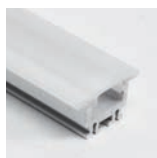

SIHON 58



TAU 52



PIATTO 71

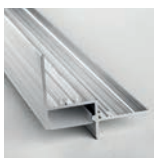

VELA 68

STRIP LED | STRIP LED

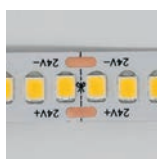

20,2 78

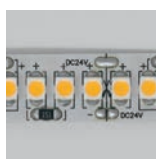

19,2 79



DYN. WHITE 80



RGB+WHITE 80



14,4 81



9,6 84

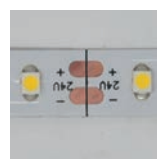

4,8 85



IP67 86

SISTEMI | SYSTEMS

FOCUS 300

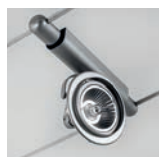

0211 99

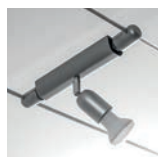

0272 0282 97



0240 95



0243 96



0234 0251 98



0289 91



0290 93

FOCUS 160



0434 0435 107



0457 103

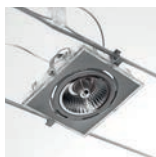

0458 104



0472 106



0490 105

TWIN



0353 118



0354 121



0355 119

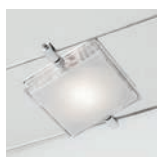

0357 111

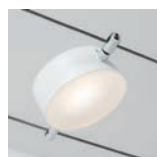

0358 113



0360 114



0361 0362 115

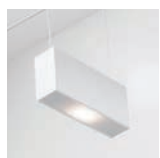

0363 117



1410 125



3110 122



3310 123



0631 127



0635 128



0639 129



0640 129

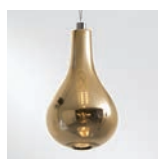

0644 128



0646 128



0647 127



0648 127



0649 129

DECORATIVO | DECORATIVO

PARETE | WALL FIXTURES

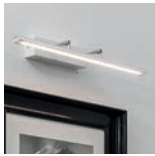

ARTE 220



BETA 218



DADAJÈ 172



DADAJÈ 174



DADAJÈ 176

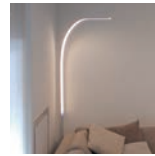

DEGAS 196



GIOTTO 187



GIOTTO 189



INCROCIO 154



INCROCIO 156



LIBRO 142



MILO 216



MILO 214



MILO 215



MODÌ 145



OMICRON 151



PICASSO 206

SOFFITTO | CEILING FIXTURES



BRIDGE 137



DADAJÈ 175



DADAJÈ 177



DADAJÈ 178



GIOTTO 187



INCROCIO 160



KITE 213



MILO 217

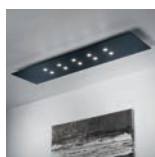

MONET 200

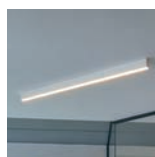

OMICRON 147



RIFLESSI 210



SWING 141



SWING 140

TERRA | FLOOR FIXTURES

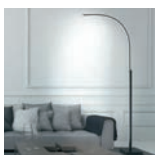

DEGAS 196

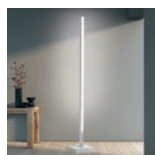

DEGAS 199

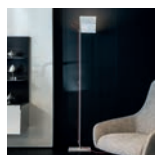

MODÌ 145

TAVOLO | TABLE FIXTURES



BETA 218

DECORATIVO | DECORATIVO

FARETTI | SPOT



BETA 219



DADAJÈ 175



JARIS 221



JARIS 223



MILO 216



MILO 215



SPOT 221

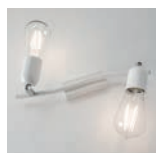

SPOT 222

SOSPENSIONI | SUSPENSIONS



DADAJÈ 179



DEGAS 195

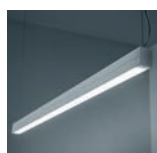

DEGAS 191



EDERA 165



GIOTTO 184



GIOTTO 181



INCROCIO 162

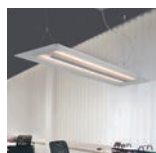

KITE 212



MONET 202



OMICRON 149

INCASSO | RECESSED SPOTS



1008 239



1010 240



1011 241



1038 239



1040 240



1041 241

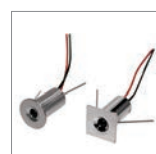

11301 227



11302 228



11303 229



11314 231



11401 234



11411 235



11421 236



11431 237



11481 238



11462 233

PROFILI

OMICRON
SIGMA
OMEGA
DELTA
TAU
SIHON
B-LIGHT
MICRO
VELA
KAPPA
PIATTO
RESINATI
ETHA
STRIP FLEX

PROFILI

OMICRON

Design Athena

Sistema modulare in alluminio verniciato completo di policarbonato PMMA. Disponibile nelle finiture bianco, nero, oro, corten e grigio. Gli accessori in dotazione permettono di comporre il sistema in varie soluzioni. I moduli vengono tagliati a misura secondo le esigenze del cliente e forniti completi di led. Alimentatori e accessori di dimmerazione vengono inseriti direttamente nel profilo. Tappi, drivers e accessori da ordinare separatamente in funzione del sistema da comporre.

Alluminium modular painted profiles completed with polycarbonate PMMA. It is available in white, black, gold, corten and grey. The attached accessories give the possibility to compose the system in various solutions. The modules are custom cut to meet the needs of the clients and are already sold with Leds. Power supplies and accessories are placed directly inside the profile. Caps, drivers and accessories are to be ordered separately based on the system to be composed.



MODULI A PLAFONE TAGLIATI A MISURA COMPLETI DI LED

Il codice del prodotto è riferito a 10 cm di modulo completo di led. Per definire la lunghezza finale del modulo considerare la misura di taglio del led.

Composizione Codice: modulo 1 linea led - bianco - WW - schermo satinato = 98210109.5.6.1 cm...

TAILORED CUT CEILING FIXTURES WITH LED

The code of the product is referred to 10 cm of it. To define the final length of the ceiling module consider the cut measure of the led.

Code Composition: profile 1 led line - White - WW - satin screen = 98210109..5.6.1 cm...

OMICRON LED PLAFONE MODULARE

Modulo composto da: profilo in alluminio, Led e schermo in policarbonato. Tappi, drivers e accessori da ordinare separatamente.
 Profile, Led and polycarbonate PMMA screen included. Dead ends, drivers and accessories must be ordered separately.



OMICRON PL 19 - 1 Linea led

240 led/mt 19,2 w/mt
 Lm/m 1580/1540/1490
 24 Vdc CRI90 **A** SDCM3

30.000h -20° +40° cm 2,5

Code - 10 cm

98210109



Color

- 3 Gold
- 4 Corten
- 5 White
- 7 Grey
- 9 Black

Led

- 1 4000°K
- 6 3000°K
- 8 2700°K



OMICRON PL 19 - 2 Linee led

240 led/mt 38,4 w/mt
 Lm/m 3160/3080/2980
 24 Vdc CRI90 **A** SDCM3

30.000h -20° +40° cm 2,5

Code - 10 cm

98210209



Color

- 3 Gold
- 4 Corten
- 5 White
- 7 Grey
- 9 Black

Led

- 1 4000°K
- 6 3000°K
- 8 2700°K



OMICRON PL 20 - 1 Linea led

224 led/mt 20,2 w/mt
 Lm/m 3114/2937/2740
 24 Vdc CRI90 **A** SDCM3

30.000h -20° +40° cm 3,57

Code - 10 cm

98310109



Color

- 3 Gold
- 4 Corten
- 5 White
- 7 Grey
- 9 Black

Led

- 1 4000°K
- 6 3000°K
- 8 2700°K



OMICRON PL 20 - 2 Linee led

224 led/mt 40,4 w/mt
 Lm/m 6228/5874/5480
 24 Vdc CRI90 **A** SDCM3

30.000h -20° +40° cm 3,57

Code - 10 cm

98310209



Color

- 3 Gold
- 4 Corten
- 5 White
- 7 Grey
- 9 Black

Led

- 1 4000°K
- 6 3000°K
- 8 2700°K

SCHERMI



1 Satinato 4 Curvo 5 Prismatico

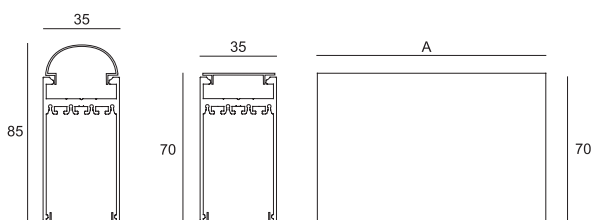

A: Color: 3 max cm 200 - 4-5-7-9 max cm 300

Led CRI >90 **A** CE IP 40



ACCESSORI OMICRON PLAFONE MODULARE



UGR<19 in funzione dell'installazione.
Utilizzabile solo con schermo prismatico. Fornito già assemblato nel modulo.
UGR<19 depending on installation. Use only with prismatic screen.
Already assembled into the module.

Code cm10

9895







Tappo piatto
Flat dead end

Code

9851



Color

- 3  Gold
- 4  Corten
- 5  White
- 7  Grey
- 9  Black







Tappo curvo
Curved flat end

Code

9852



Color

- 3  Gold
- 4  Corten
- 5  White
- 7  Grey
- 9  Black



Kit plafone
Ceiling Kit

Code

9853

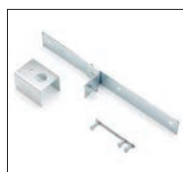

Kit Congiunzione
Junction Kit

Code

9854







Modulo vuoto plafone
Empty ceiling module

Code - cm 10

9897

Color

- 3  Gold
- 4  Corten
- 5  White
- 7  Grey
- 9  Black

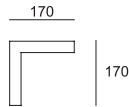

Curva 90° orizzontale - 90° Horizontal corner

Code	Color	Led 19,2 w/mt
98210111	3 Gold	1 LINEA LED 1 4000°K 5,7W 474 lm 6 3000°K 5,7W 462 lm 8 2700°K 5,7W 447 lm
	4 Corten	
	5 White	
98210211	7 Grey	2 LINEE LED 1 4000°K 10,6W 849 lm 6 3000°K 10,6W 847 lm 8 2700°K 10,6W 820 lm
	9 Black	

Code	Color	Led 20,2 w/mt
98310111	3 Gold	1 LINEA LED 1 4000°K 5,8W 888 lm 6 3000°K 5,8W 832 lm 8 2700°K 5,8W 776 lm
	4 Corten	
	5 White	
98310211	7 Grey	2 LINEE LED 1 4000°K 11,6W 1776 lm 6 3000°K 11,6W 1664 lm 8 2700°K 11,6W 1553 lm
	9 Black	

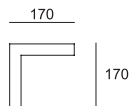

Curva 90° verticale luce IN - 90° Vertical corner light IN

Code	Color	Led 19,2 w/mt
98210112	3 Gold	1 LINEA LED 1 4000°K 3,9W 316 lm 6 3000°K 3,9W 308 lm 8 2700°K 3,9W 298 lm
	4 Corten	
	5 White	
98210212	7 Grey	2 LINEE LED 1 4000°K 7,7W 632 lm 6 3000°K 7,7W 616 lm 8 2700°K 7,7W 596 lm
	9 Black	

Code	Color	Led 20,2 w/mt
98310112	3 Gold	1 LINEA LED 1 4000°K 4,4W 666 lm 6 3000°K 4,4W 624 lm 8 2700°K 4,4W 582 lm
	4 Corten	
	5 White	
98310212	7 Grey	2 LINEE LED 1 3000°K 8,8W 1332 lm 6 3000°K 8,8W 1248 lm 8 2700°K 8,8W 1165 lm
	9 Black	

ACCESSORI OMICRON PLAFONE MODULARE

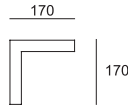

Curva 90° verticale luce OUT - 90° Vertical corner light OUT

Code	Color	Led 19,2 w/mt
98210113	3 Gold	1 LINEA LED 1 4000°K 5,7W 474 lm 6 3000°K 5,7W 462 lm 8 2700°K 5,7W 447 lm
	4 Corten	
	5 White	
	7 Grey	
	9 Black	
98210213	3 Gold	2 LINEE LED 1 4000°K 11,5W 948 lm 6 3000°K 11,5W 924 lm 8 2700°K 11,5W 894 lm
	4 Corten	
	5 White	
	7 Grey	
	9 Black	



GR 372



GR 386



Code	Color	Led 20,2 w/mt
98310113	3 Gold	1 LINEA LED 1 4000°K 5,8W 888 lm 6 3000°K 5,8W 832 lm 8 2700°K 5,8W 776 lm
	4 Corten	
	5 White	
	7 Grey	
	9 Black	
98310213	3 Gold	2 LINEE LED 1 4000°K 11,6W 1776 lm 6 3000°K 11,6W 1664 lm 8 2700°K 11,6W 1552 lm
	4 Corten	
	5 White	
	7 Grey	
	9 Black	



GR 372



GR 386

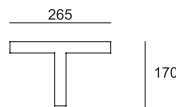

Congiunzione a T - T junction

Code	Color	Led 19,2 w/mt
98210114	3 Gold	1 LINEA LED 1 4000°K 7,2W 593 lm 6 3000°K 7,2W 578 lm 8 2700°K 7,2W 560 lm
	4 Corten	
	5 White	
	7 Grey	
	9 Black	
98210214	3 Gold	2 LINEE LED 1 4000°K 14,4W 1186 lm 6 3000°K 14,4W 1156 lm 8 2700°K 14,4W 1118 lm
	4 Corten	
	5 White	
	7 Grey	
	9 Black	



GR 486



GR 500



Code	Color	Led 20,2 w/mt
98310114	3 Gold	1 LINEA LED 1 4000°K 8W 1221 lm 6 3000°K 8W 1144 lm 8 2700°K 8W 1068 lm
	4 Corten	
	5 White	
	7 Grey	
	9 Black	
98310214	3 Gold	2 LINEE LED 1 4000°K 16W 2442 lm 6 3000°K 16W 2288 lm 8 2700°K 16W 2135 lm
	4 Corten	
	5 White	
	7 Grey	
	9 Black	



GR 486



GR 500

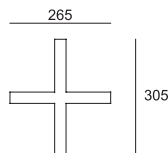
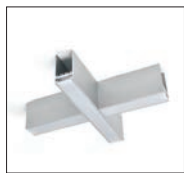

Congiunzione a croce - Cross junction

Code	Color	Led 19,2 w/mt
98210118	3 Gold	1 LINEA LED 1 4000°K 9,6W 790 lm 6 3000°K 9,6W 770 lm 8 2700°K 9,6W 745 lm
	4 Corten	
	5 White	
	7 Grey	
	9 Black	
98210218	3 Gold	2 LINEE LED 1 4000°K 19,2W 1580 lm 6 3000°K 19,2W 1540 lm 8 2700°K 19,2W 1490 lm
	4 Corten	
	5 White	
	7 Grey	
	9 Black	



GR 650



GR 670



Code	Color	Led 20,2 w/mt
98310118	3 Gold	1 LINEA LED 1 4000°K 8,7W 1332 lm 6 3000°K 8,7W 1248 lm 8 2700°K 8,7W 1165 lm
	4 Corten	
	5 White	
	7 Grey	
	9 Black	
98310218	3 Gold	2 LINEE LED 1 4000°K 17,4W 2442 lm 6 3000°K 17,4W 2288 lm 8 2700°K 17,4W 2134 lm
	4 Corten	
	5 White	
	7 Grey	
	9 Black	



GR 650



GR 670





ALIMENTATORI inseribili nei moduli a plafone
 DRIVERS to insert into ceiling modules

Code		
1240	max 20W	24Vdc
1241	max 35W	24Vdc
1242	max 60W	24Vdc
1201	max 75W	24Vdc
1202	max 100W	24Vdc
1181	max 150W	24Vdc

CENTRALINE PER DIMMERAZIONE inseribili nei moduli a plafone
 DIMMABLE DRIVERS to insert into ceiling modules

Code		
1300	max 240W	Master/Slave PUSH 0-10v 1-10v
1303	max 240W	CASAMBI
1304	max 240W	DALI - PUSH 0-10v

Grafico composizione sistema
System composition

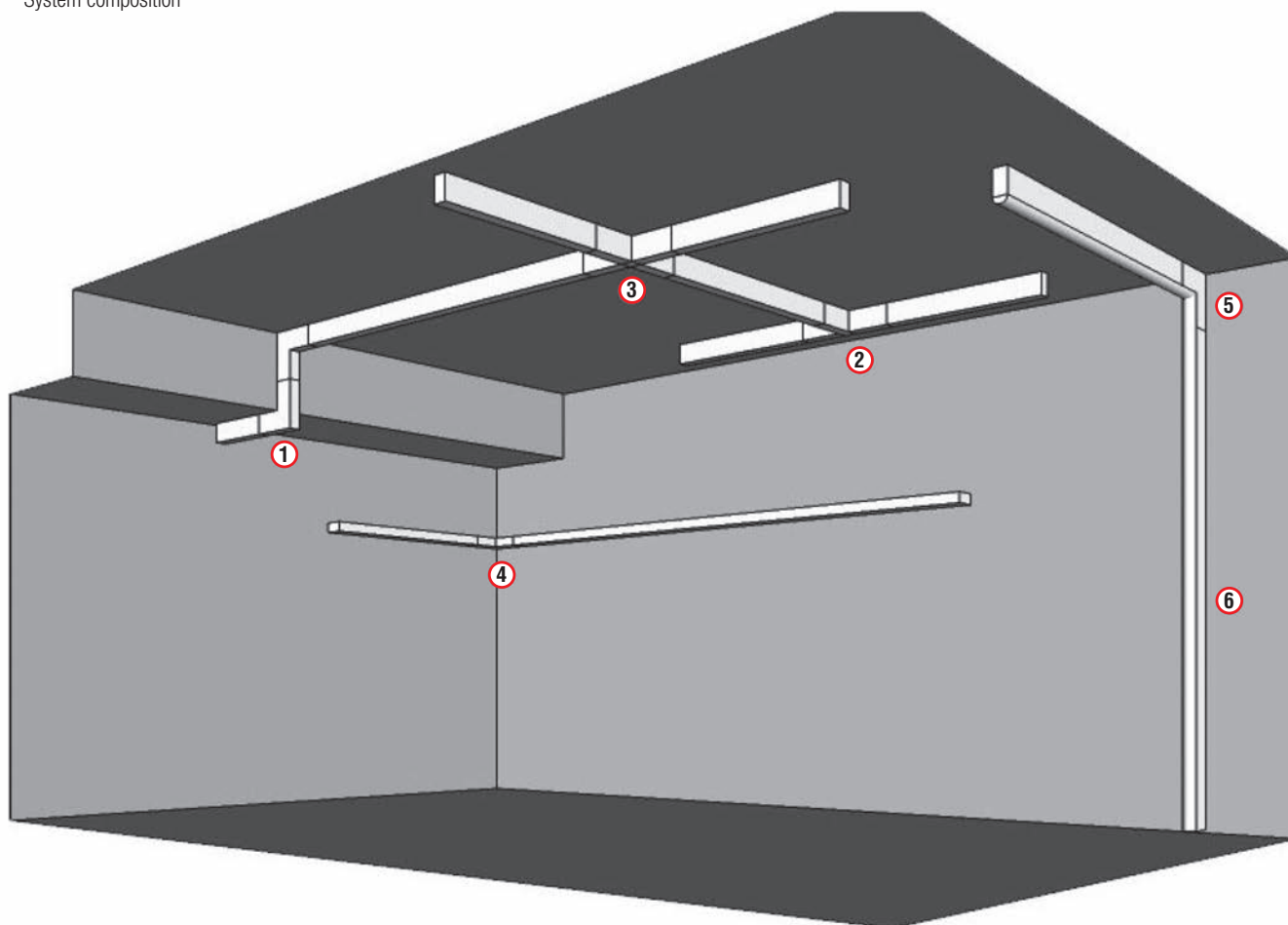

① **98210113 - 98210213**
98310113 - 98310213

Curva 90° Verticale luce OUT
90° vertical corner light OUT

② **98210114 - 98210214**
98310114 - 98310214

Congiunzione a T
T junction

③ **98210118 - 98210218**
98310118 - 98310218

Congiunzione a croce
Cross junction

④ **98210111 - 98210211**
98310111 - 98310211

Curva 90° orizzontale
90° horizontal corner

⑤ **98210112 - 98210212**
98310112 - 98310212

Curva 90° Verticale luce IN
90° vertical corner light IN

⑥ **98210109 - 98210209**
98310109 - 98310209

Omicron led plafone modulare
Omicron led ceiling module

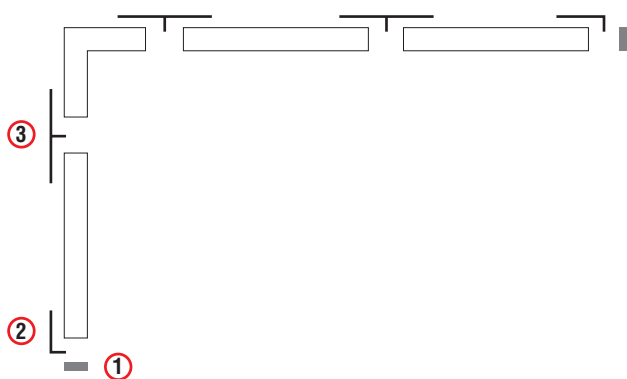

① **9851 - 9852**

Tappo - Dead end

② **9853**

Kit Plafone - Ceiling kit

③ **9854**

Kit congiunzione - Junction kit



BROTT.TO



OMICRON LED SOSPENSIONE MODULARE

Modulo composto da: profilo in alluminio, Led, due kit sospensione e schermo in policarbonato PMMA.
Kit alimentazione, tappi, drivers e accessori da ordinare separatamente.

Profile, led, two suspension kit and polycarbonate PMMA screen included. Electricity supply, dead ends, drivers and accessories must be ordered separately.

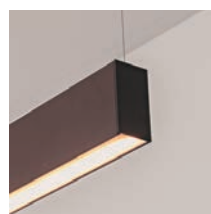

OMICRON S019 - 1 Linea led

240 led/mt 19,2 w/mt
Lm/m 1580/1540/1490
24 Vdc CRI90 **A** SDCM3

30.000h $-20^{\circ} + 40^{\circ}$ cm 2,5

Code - 10 cm

98510109



Color

3 Gold
4 Corten
5 White
7 Grey
9 Black

Led

1 4000°K
6 3000°K
8 2700°K

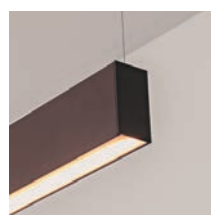

OMICRON S019 - 2 Linee led

240 led/mt 38,4 w/mt
Lm/m 3160/3080/2980
24 Vdc CRI90 **A** SDCM3

30.000h $-20^{\circ} + 40^{\circ}$ cm 2,5

Code - 10 cm

98510209



Color

3 Gold
4 Corten
5 White
7 Grey
9 Black

Led

1 4000°K
6 3000°K
8 2700°K

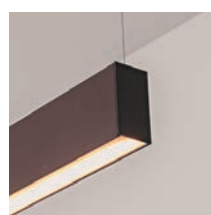

OMICRON S019 - 1+1 Linea led

240 led/mt 19,2+19,2 w/mt
Lm/m 1580+1580/1540+1540/1490+1490
24 Vdc CRI90 **A** SDCM3

30.000h $-20^{\circ} + 40^{\circ}$ cm 2,5

Code - 10 cm

98511109



Color

3 Gold
4 Corten
5 White
7 Grey
9 Black

Led

1 4000°K
6 3000°K
8 2700°K

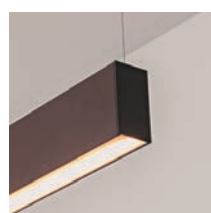

OMICRON S019 - 1+2 Linee led

240 led/mt 19,2+38,4 w/mt
Lm/m 1580+3160/1540-3080/1490+2980
24 Vdc CRI90 **A** SDCM3

30.000h $-20^{\circ} + 40^{\circ}$ cm 2,5

Code - 10 cm

98511209



Color

3 Gold
4 Corten
5 White
7 Grey
9 Black

Led

1 4000°K
6 3000°K
8 2700°K

SOSPENSIONI TAGLIATE A MISURA COMPLETE DI LED

Il codice del prodotto è riferito a 10 cm di sospensione completa di led.

Per definire la lunghezza finale della sospensione considerare la misura di taglio del led.

TAILORED CUT suspensions with LED

The code of the product is referred to 10 cm of it.

To define the final length of the suspension consider the cut measure of the led.



OMICRON S020 - 1 Linea led

224 led/mt 20,2 w/mt
Lm/m 3114/2937/2740
24 Vdc CRI90 **A** SDCM3

30.000h $-20^{\circ} + 40^{\circ}$ cm 3,57

Code - 10 cm

98710109



Color

- 4 Corten
- 5 White
- 7 Grey
- 9 Black

Led

- 1 4000°K
- 6 3000°K
- 8 2700°K



OMICRON S020 - 2 Linee led

224 led/mt 40,4 w/mt
Lm/m 6228/5874/5480
24 Vdc CRI90 **A** SDCM3

30.000h $-20^{\circ} + 40^{\circ}$ cm 3,57

Code - 10 cm

98710209



Color

- 4 Corten
- 5 White
- 7 Grey
- 9 Black

Led

- 1 4000°K
- 6 3000°K
- 8 2700°K

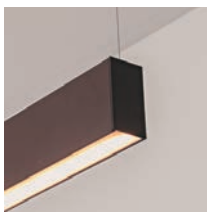

OMICRON S020 - 1+1 Linea led

224 led/mt 20,2 w/mt+20,2 w/mt
Lm/m 3114+3114/2937+2937/2740+2740
24 Vdc CRI90 **A** SDCM3

30.000h $-20^{\circ} + 40^{\circ}$ cm 3,57

Code - 10 cm

98711109



Color

- 4 Corten
- 5 White
- 7 Grey
- 9 Black

Led

- 1 4000°K
- 6 3000°K
- 8 2700°K

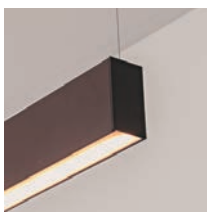

OMICRON S020 - 1+2 Linee led

224 led/mt 20,2 w/mt+40,4 w/mt
Lm/m 3114+6228/2937+5874/2740+5480
24 Vdc CRI90 **A** SDCM3

30.000h $-20^{\circ} + 40^{\circ}$ cm 3,57

Code - 10 cm

98711209



Color

- 4 Corten
- 5 White
- 7 Grey
- 9 Black

Led

- 1 4000°K
- 6 3000°K
- 8 2700°K

SCHERMI



1 Satinato

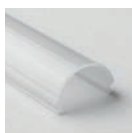

4 Curvo



5 Prismatico

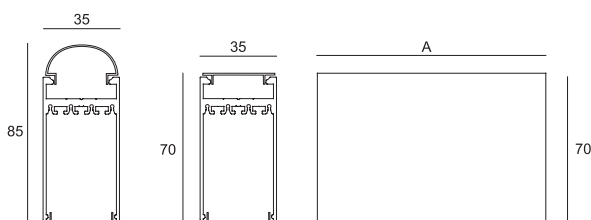

A: Color: 3 max cm 200 - 4-5-7-9 max cm 300

Led CRI > 90 **A** CE IP 40



ACCESSORI PER SISTEMA MODULARE A SOSPENSIONE



UGR<19 in funzione dell'installazione.
Utilizzabile solo con schermo prismatico. Fornito già assemblato nel modulo.
UGR<19 depending on installation. Use only with prismatic screen.
Already assembled into the module.

Code - cm 10

9895



Tappo piatto
Flat dead end

Code

9851



Color

- 3 Gold
- 4 Corten
- 5 White
- 7 Grey
- 9 Black



Tappo curvo
Curved flat end

Code

9852



Color

- 3 Gold
- 4 Corten
- 5 White
- 7 Grey
- 9 Black



Kit Congiunzione
Junction Kit

Code

9858



Kit Alimentazione
Electricity supply Kit

A richiesta cavi colorati/On request coloured cables

- 2 Blue
- 5 White
- 8 Red
- 9 Black

Cavo in tessuto cm 200

Code

9857



Color

- 3 Gold
- 4 Corten
- 5 White
- 7 Grey
- 9 Black



Modulo vuoto plafone sospensione
Empty suspension module

Code cm10

9898

Color

- 3 Gold
- 4 Corten
- 5 White
- 7 Grey
- 9 Black

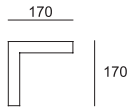

Curva 90° orizzontale - 90° Horizontal corner

Code	Color	Led 19,2 w/mt		
98510111	3 Gold	1 LINEA LED 1 4000°K 5,7W 474 lm 6 3000°K 5,7W 462 lm 8 2700°K 5,7W 447 lm		
	4 Corten			
	5 White			
	7 Grey			
	9 Black			
98510211	3 Gold	2 LINEE LED 1 4000°K 10,6W 869 lm 6 3000°K 10,6W 847 lm 8 2700°K 10,6W 820 lm		
	4 Corten			
	5 White			
	7 Grey			
	9 Black			
98710111	3 Gold	1 LINEA LED 1 4000°K 5,8W 888 lm 6 3000°K 5,8W 832 lm 8 2700°K 5,8W 776 lm		
	4 Corten			
	5 White			
	7 Grey			
	9 Black			
98710211	3 Gold	2 LINEE LED 1 4000°K 11,6W 1776 lm 6 3000°K 11,6W 1664 lm 8 2700°K 11,6W 1553 lm		
	4 Corten			
	5 White			
	7 Grey			
	9 Black			

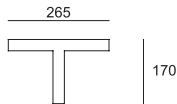

Congiunzione a T - T junction

Code	Color	Led 19,2 w/mt		
98510114	3 Gold	1 LINEA LED 1 4000°K 7,2W 593 lm 6 3000°K 7,2W 578 lm 8 2700°K 7,2W 560 lm		
	4 Corten			
	5 White			
	7 Grey			
	9 Black			
98510214	3 Gold	2 LINEE LED 1 4000°K 14,4W 1186 lm 6 3000°K 14,4W 1156 lm 8 2700°K 14,4W 1118 lm		
	4 Corten			
	5 White			
	7 Grey			
	9 Black			
98710114	3 Gold	1 LINEA LED 1 4000°K 8W 1221 lm 6 3000°K 8W 1144 lm 8 2700°K 8W 1068 lm		
	4 Corten			
	5 White			
	7 Grey			
	9 Black			
98710214	3 Gold	2 LINEE LED 1 4000°K 16W 2442 lm 6 3000°K 16W 2288 lm 8 2700°K 16W 2135 lm		
	4 Corten			
	5 White			
	7 Grey			
	9 Black			

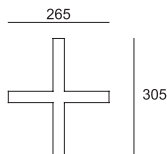

Congiunzione croce - Cross junction

Code	Color	Led 19,2 w/mt		
98510118	3 Gold	1 LINEA LED 1 4000°K 9,6W 790 lm 6 3000°K 9,6W 770 lm 8 2700°K 9,6W 745 lm		
	4 Corten			
	5 White			
	7 Grey			
	9 Black			
98510218	3 Gold	2 LINEE LED 1 4000°K 19,2W 1580 lm 6 3000°K 19,2W 1540 lm 8 2700°K 19,2W 1480 lm		
	4 Corten			
	5 White			
	7 Grey			
	9 Black			
98710118	3 Gold	1 LINEA LED 1 4000°K 8,7W 1332 lm 6 3000°K 8,7W 1248 lm 8 2700°K 8,7W 1165 lm		
	4 Corten			
	5 White			
	7 Grey			
	9 Black			
98710218	3 Gold	2 LINEE LED 1 4000°K 17,4W 2664 lm 6 3000°K 17,4W 2496 lm 8 2700°K 17,4W 2328 lm		
	4 Corten			
	5 White			
	7 Grey			
	9 Black			



ALIMENTATORI inseribili nei moduli a sospensione
DRIVERS to insert into suspension modules

Code		
1240	max 20W	24Vdc
1241	max 35W	24Vdc
1242	max 60W	24Vdc
1201	max 75W	24Vdc
1202	max 100W	24Vdc
1181	max 150W	24Vdc

CENTRALINE PER DIMMERAZIONE inseribili nei moduli a sospensione
DIMMABLE DRIVERS to insert into suspension modules

Code		
1300	max 240W	Master/Slave PUSH 0-10v 1-10v
1303	max 240W	CASAMBI
1304	max 240W	DALI - PUSH 0-10v

Grafico composizione sistema
System composition

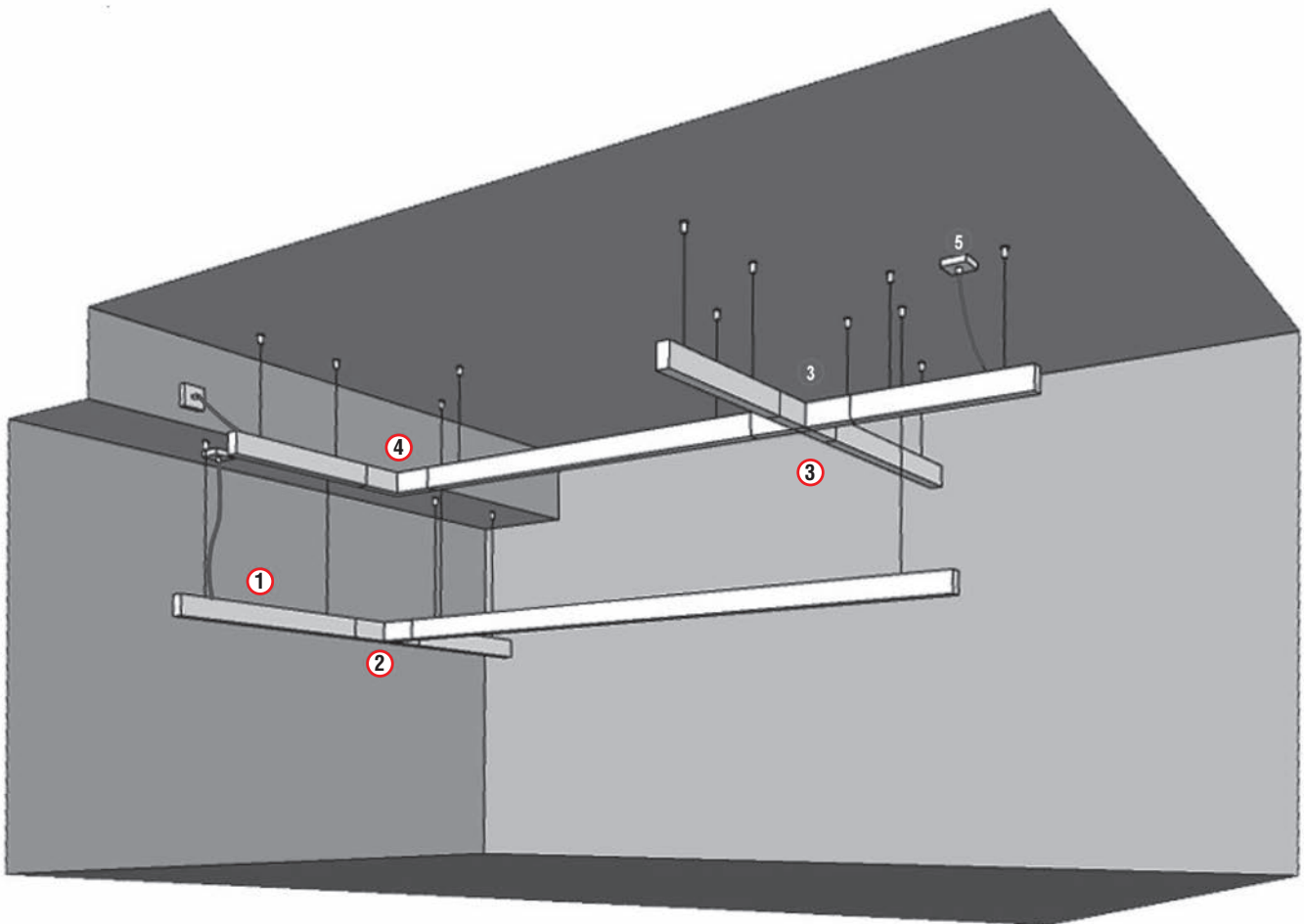

- ① **98510109 - 98510209**
98511109 - 98511209
98710109 - 98710209
98711109 - 98711209

Omicron led sospensione modulare
Omicron led modular suspension

- ② **98510114 - 98510214**
98710114 - 98710214

Congiunzione a T
T junction

- ③ **98510118 - 98510218**
98710118 - 98710218

Congiunzione a croce
Cross junction

- ④ **98210111 - 98210211**
98710111 - 98710211

Curva 90° orizzontale
90° horizontal corner

- ⑤ **9857**

Kit alimentazione
Electricity supply kit

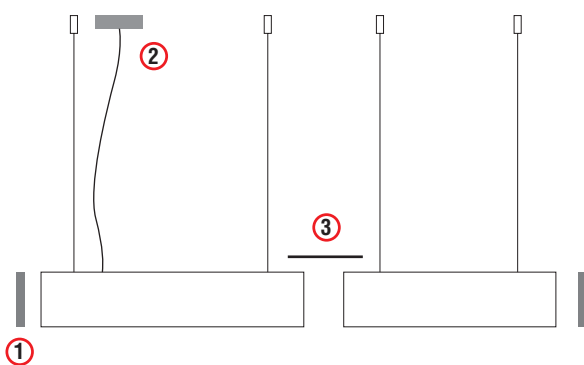

- ① **9851 - 9852**
Tappo piatto - Flat dead end
- ② **9857**
Kit Alimentazione - Electricity supply kit
- ③ **9858**
Kit congiunzione - Junction kit

SIGMA

Design Athena

Profilo in alluminio anodizzato completo di strip LED. Schermo in policarbonato, cavo alimentazione mm 2000.

Anodized aluminium profile completed with strip LED. Polycarbonate screen, wire lenght mm 2000.

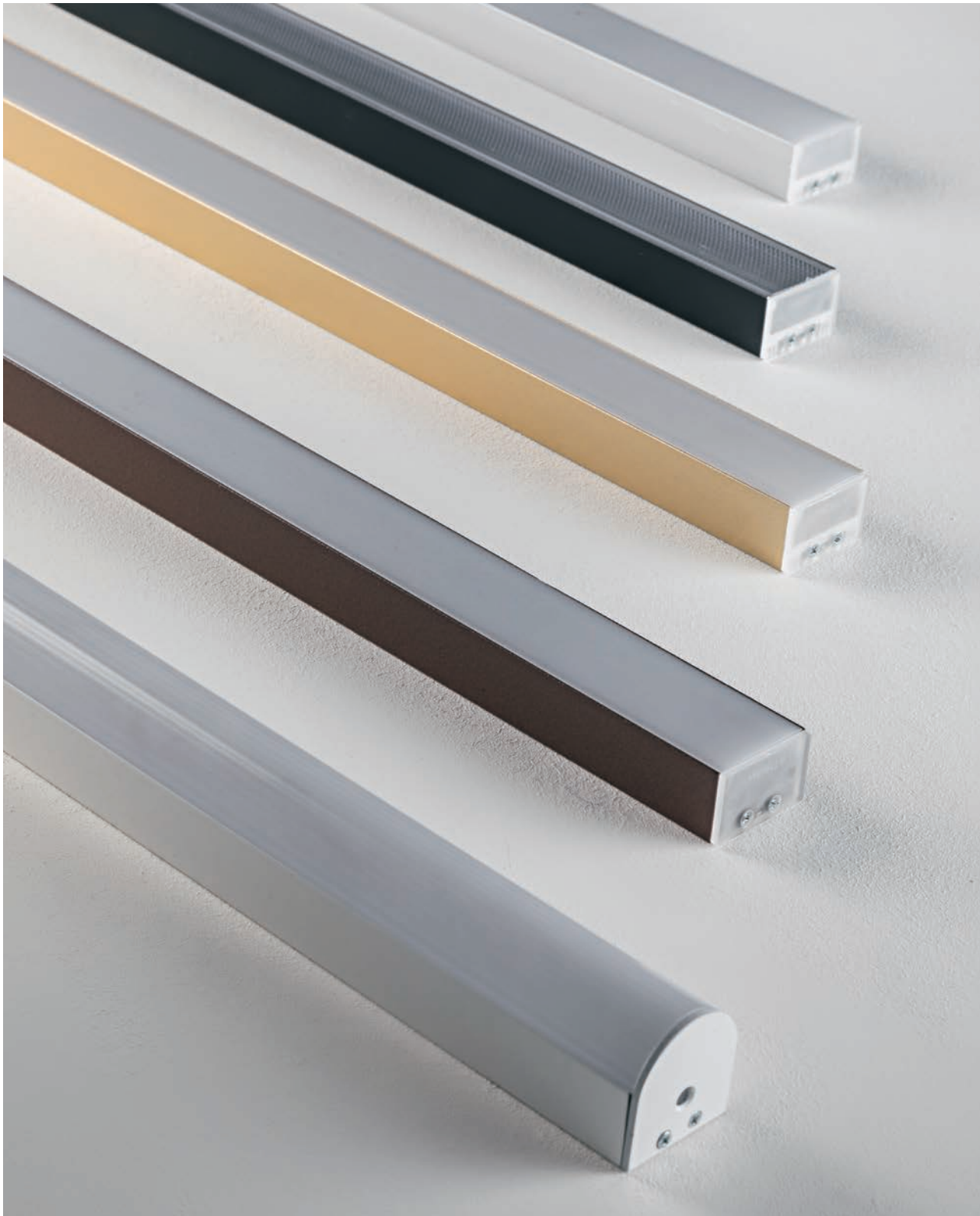

PROFILI TAGLIATI A MISURA PERSONALIZZATA COMPLETI DI LED

Il codice del prodotto è riferito a 10 cm di modulo completo di led. Per definire la lunghezza finale del profilo considerare la misura di taglio del led.

Composizione Codice: modulo cm 270 bianco - 19.2 WW - schermo piatto = 9019.5.6.1 cm 270

TAILORED CUT PROFILES WITH LED

The code of the product is referred to 10 cm of it. To define the final length of the profile consider the cut measure of the led.

Code Composition: profile cm 270 - White - 19.2 WW - flat screen = 9019.5.6.1 cm 270

SIGMA LED 1

Design Athena



SIGMA LED 14 - 1 linea led

140 led/mt 14,4 w/mt
Lm/m 1947/1836/1712
24 Vdc CRI90 **A** SDCM3

30.000h $-20^{\circ} + 40^{\circ}$ cm 5

Code - 10 cm

9024

Color

- 2 Aluminium
- 3 Gold
- 4 Corten
- 5 White
- 9 Black

Led

- 1 4000°K
- 6 3000°K
- 8 2700°K



SIGMA LED 19 - 1 linea led

240 led/mt 19,2 w/mt
Lm/m 1580/1540/1490
24 Vdc CRI90 **A** SDCM3

30.000h $-20^{\circ} + 40^{\circ}$ cm 2,5

Code - 10 cm

9019

Color

- 2 Aluminium
- 3 Gold
- 4 Corten
- 5 White
- 9 Black

Led

- 1 4000°K
- 6 3000°K
- 8 2700°K



SIGMA LED 20 - 1 linea led

224 led/mt 20,2 w/mt
Lm/m 3114/2937/2740
24 Vdc CRI90 **A** SDCM3

30.000h $-20^{\circ} + 40^{\circ}$ cm 3,57

Code - 10 cm

9021

Color

- 2 Aluminium
- 3 Gold
- 4 Corten
- 5 White
- 9 Black

Led

- 1 4000°K
- 6 3000°K
- 8 2700°K

SCHERMI



1 Satinato

4 Curvo

5 Prismatico

ACCESSORI Dettagli pag 32-33

9654
Kit
sospensione

9656
Supporto
fisso

9659
Supporto
orientabile

9661
Supporto
calamita

9662
Supporto
sbalzo

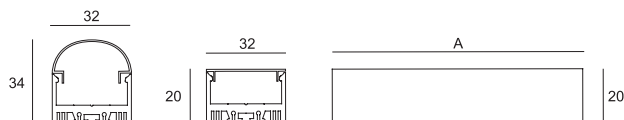

A: Color: 2 max cm 400 - 4-5-9 max cm 300 - 3 max cm 200

Led CRI >90 **A** CE IP 40

SIGMA LED 2

Design Athena



SIGMA LED 14 - 2 linee led

140 led/mt 14,4 w/mt
Lm/m 3894/3672/3424
24 Vdc CRI90 **A** SDCM3

30.000h -20°+40° cm 5

Code - 10 cm

90224

Color

2 Aluminium
3 Gold
4 Corten
5 White
9 Black

Led

1 4000°K
6 3000°K
8 2700°K



SIGMA LED 19 - 2 linee led

240 led/mt 19,2 w/mt
Lm/m 3160/3080/2980
24 Vdc CRI90 **A** SDCM3

30.000h -20°+40° cm 2,5

Code - 10 cm

90219

Color

2 Aluminium
3 Gold
4 Corten
5 White
9 Black

Led

1 4000°K
6 3000°K
8 2700°K



SIGMA LED 20 - 2 linee led

224 led/mt 20,2 w/mt
Lm/m 6228/5874/5480
24 Vdc CRI90 **A** SDCM3

30.000h -20°+40° cm 3,57

Code - 10 cm

90221

Color

2 Aluminium
3 Gold
4 Corten
5 White
9 Black

Led

1 4000°K
6 3000°K
8 2700°K

SCHERMI



1 Satinato

4 Curvo

5 Prismatico

ACCESSORI Dettagli pag 32-33

9654
Kit
sospensione

9656
Supporto
fissa

9659
Supporto
orientabile

9661
Supporto
calamita

9662
Supporto
sbalzo

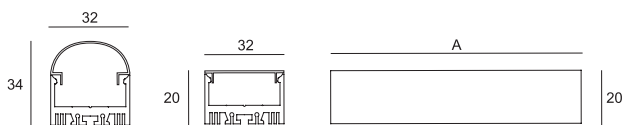

A: Color: 2 max cm 400 - 4-5-9 max cm 300 - 3 max cm 200

Led CRI >90 **A** CE IP 40



SIGMA

Design Athena

Profilo in alluminio estruso con schermo in policarbonato PMMA. Disponibile nelle finiture alluminio gold, corten, bianco e nero.



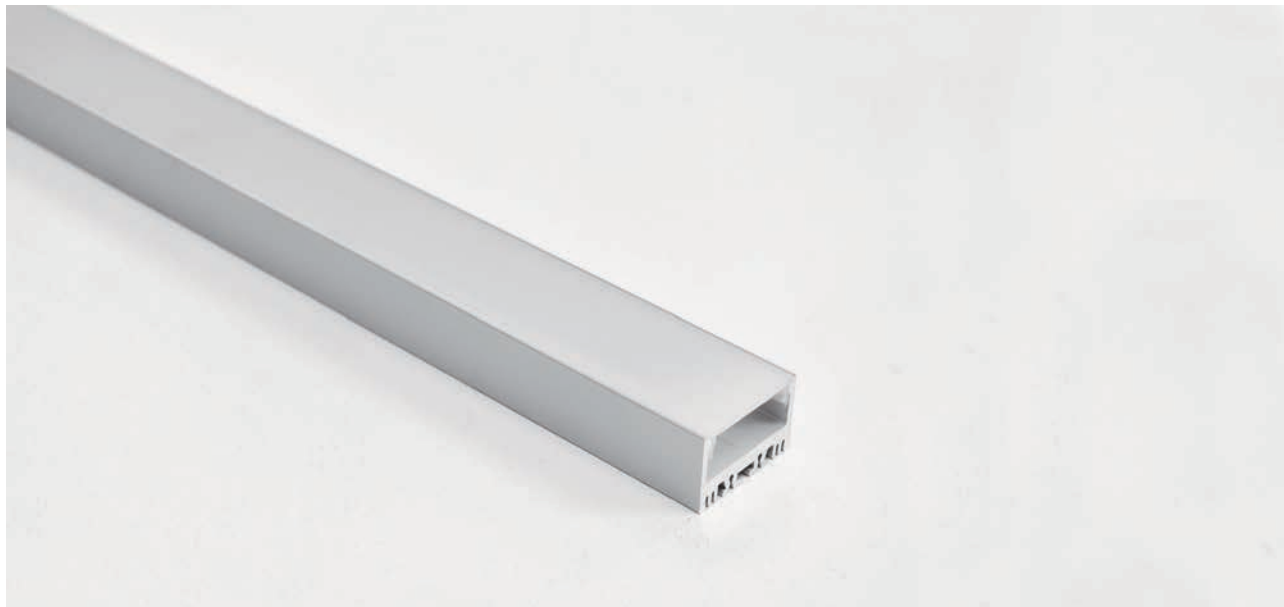

Anodized aluminium profile completed with polycarbonate PMMA. Available in white, golden, corten, and black finishings.



Code - 10 cm

Color

9099

- | | | |
|----------|---|-----------|
| 2 |  | Aluminium |
| 3 |  | Gold |
| 4 |  | Corten |
| 5 |  | White |
| 9 |  | Black |

SCHERMI



1 Satinato

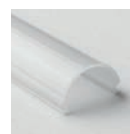

4 Curvo



5 Prismatico

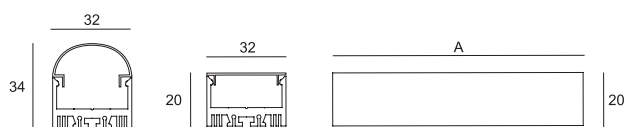

A: Color: **2** max cm 400 - **4-5-9** cm 300 - **3** max cm 200

Il codice del prodotto è riferito a 10 cm di profilo. In fase d'ordine precisare la misura del profilo richiesta.

Code number refer to 10 cm profile. Ordering, specify the length of the profile request.



ACCESSORI SIGMA



Tappo per schermo curvo
Dead-end for curved screen

Code**9047** con foro**9048** senza foro**Color****2** Aluminium**3** Gold**4** Corten**5** White**9** Black

Tappo per schermo piatto
Dead-end for flat screen

Code**9051** senza foro**9052** con foro

2



Angolo 90° verticale
90° vertical corner

**Code****9049**

180

Color**2** Aluminium**3** Gold**4** Corten**5** White**9** Black

Angolo 90° orizzontale
90° horizontal corner

**Code****9050**

180

Color**2** Aluminium**3** Gold**4** Corten**5** White**9** Black

Lavorazione taglio ad angolo 45° dei profili
45° cutting of the profiles

Code**9660**

Elemento di congiunzione meccanico
Straight mechanical connector

Code**9653**

0,8



Elemento di congiunzione meccanico per angolo 90° orizzontale
Mechanical connector for horizontal corner 90°

Code**9657**

0,8



Elemento di congiunzione meccanico per angolo 90° verticale
Mechanical connector for vertical corner 90°

Code**9658**

0,8



Supporto per sospensione H 2000 mm
Suspension kit H 2000 mm

Code**9654**

155



Supporto parete/soffitto
Wall/ceiling kit

Code

9656



Supporto parete/soffitto orientabile
Wall/ceiling adjustable kit

Code

9659



Supporto parete/soffitto a calamita
Magnet wall/ceiling support

Code

9661



Supporto parete/soffitto a sbalzo
Wall/ceiling cantilever support

Code

9662



SIGMA 3 Profilo a incasso

Design Athena

Profilo in alluminio anodizzato con schermo in policarbonato completo di accessori per installazione a scomparsa in soffitti e pareti in cartongesso.

Anodized aluminium profile with polycarbonate screen and accessories for recessed mounting.

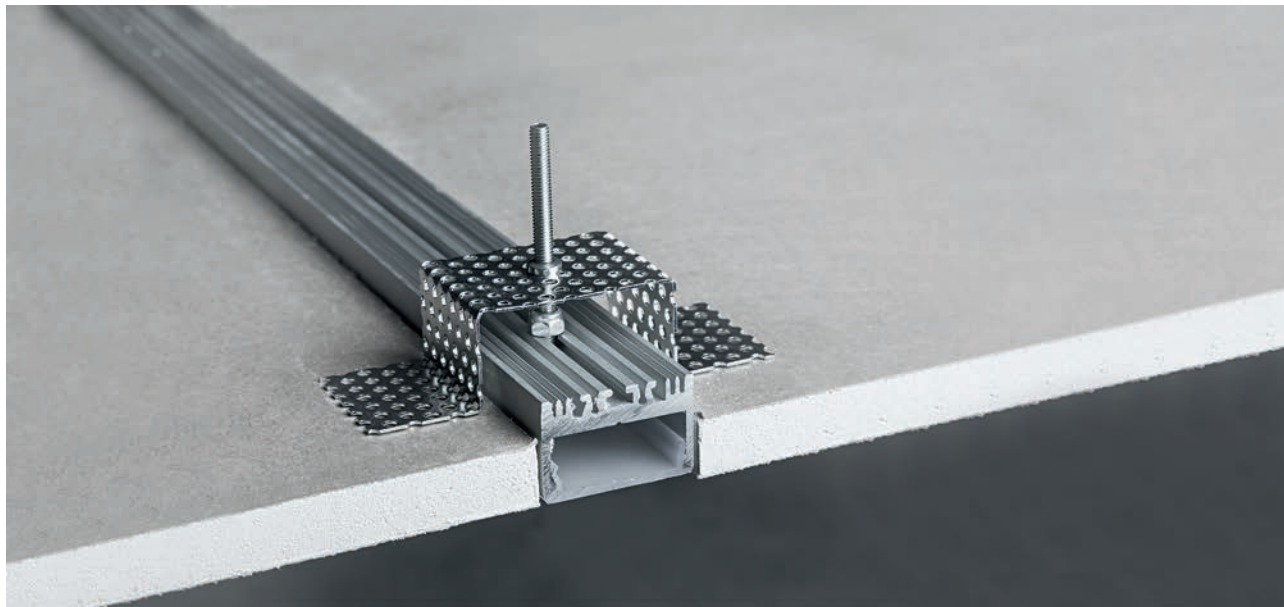

Code _____

Color _____

90399

2 Aluminium

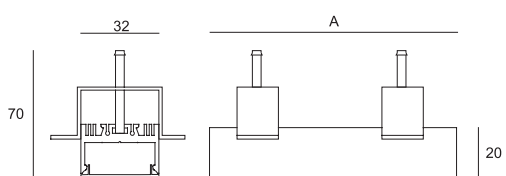

A: Lunghezza massima cm 400 - per spedizioni max cm 300

Schema installazione

Mounting scheme

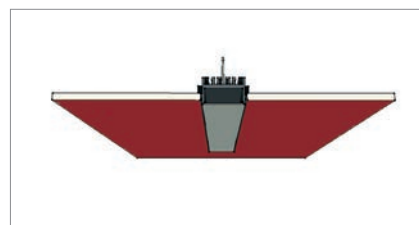
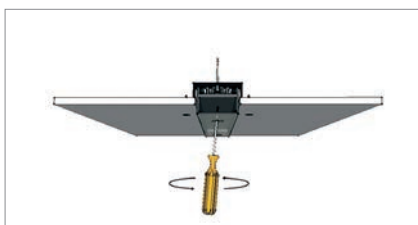
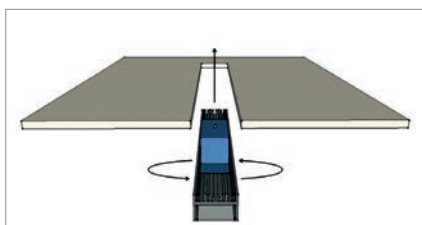

ACCESSORI SIGMA 3



Tappo
Dead-end

Code

9051 senza foro

9052 con foro



Angolo 90° verticale
90° vertical corner



Code

90349

Color

2 Aluminium



Angolo 90° orizzontale
90° horizontal corner



Code

90350

Color

2 Aluminium



Elemento di congiunzione meccanico
Straight mechanical connector

Code

9653



Elemento di congiunzione meccanico per angolo 90° orizzontale
Mechanical connector for horizontal corner 90°

Code

9657



Elemento di congiunzione meccanico per angolo 90° verticale
Mechanical connector for vertical corner 90°

Code

9658



Lavorazione taglio ad angolo 45° dei profili
45° cutting of the profiles

Code

9660

OMEGA

Design Athena

Profilo in alluminio anodizzato. Schermo in policarbonato PMMA, cavo alimentazione mm 2000.

Anodized aluminium profile and polycarbonate PMMA screen. Wire lenght mm 2000.



OMEGA WET

Design Athena

Profilo in alluminio anodizzato completo di strip LED e inserito in tubo trasparente idoneo per IP67. Schermo in policarbonato. Completo di attacco parete/soffitto, tappo di chiusura e cavo di alimentazione Fror cm 200. Idoneo per ambienti interni ed esterni.
 Anodized aluminium profile completed with strip, inserted in an IP67 clear tube. Polycarbonate screen. For indoor and outdoor environments. Complete with wall/ceiling connection, closure plug and 200 cm.

CAVO DI ALIMENTAZIONE FROR CM. 200 + TAPPO



OMEGA WET - 05

60 led/mt 4,8 w/mt
 Lm/m 400/360
 24 Vdc CRI80 **A** SDCM3

30.000h -20° +40° cm 10

Code - 10 cm

95505

Color

2 Aluminium

Led

1 4000°K
 6 3000°K



OMEGA WET - 10

60 led/mt 9,6 w/mt
 Lm/m 800/780
 24 Vdc CRI80 **A** SDCM3

30.000h -20° +40° cm 5

Code - 10 cm

95510

Color

2 Aluminium

Led

1 4000°K
 6 3000°K



OMEGA WET - 14

140 led/mt 14,4 w/mt
 Lm/m 1947/1836/1712
 24 Vdc CRI90 **A** SDCM3

30.000h -20° +40° cm 5

Code - 10 cm

95524

Color

2 Aluminium

Led

1 4000°K
 6 3000°K
 8 2700°K

SCHERMI

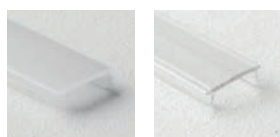

1 Satinato

2 Trasparente

PROFILI TAGLIATI A MISURA INSERITI IN TUBO TRASPARENTE E COMPLETI DI STRIP LED

Il codice del prodotto è riferito a 10 cm di profilo inserito in tubo trasparente e completo di strip led.
 Per definire la lunghezza finale del binario considerare la misura di taglio della strip + misura serracavo.

TAILORED CUT PROFILES INSERT IN A CLEAR TUBE AND COMPLETED WITH LED STRIP

The code of the product is referred to 10 cm of it.

To define the final length of the profile consider the cut measure of the strip + measure of the cablestopping.

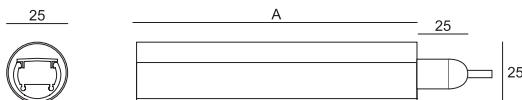

A = max cm 300

Led CRI >90 **A** CE IP 67



CAVO DI ALIMENTAZIONE FROR CM. 200 + CAVO FROR CM 20



OMEGA WET - 05

60 led/mt 4,8 w/mt
Lm/m 400/360
24 Vdc CRI90 **A** SDCM3

30.000h $-20^{\circ} + 40^{\circ}$ cm 10

Code - 10 cm

95605

Color

2 Aluminium

Led

1 4000°K

6 3000°K



OMEGA WET - 10

60 led/mt 9,6 w/mt
Lm/m 800/780
24 Vdc CRI90 **A** SDCM3

30.000h $-20^{\circ} + 40^{\circ}$ cm 5

Code - 10 cm

95610

Color

2 Aluminium

Led

1 4000°K

6 3000°K



OMEGA WET - 14

140 led/mt 14,4 w/mt
Lm/m 1947/1836/1712
24 Vdc CRI90 **A** SDCM3

30.000h $-20^{\circ} + 40^{\circ}$ cm 5

Code - 10 cm

95624

Color

2 Aluminium

Led

1 4000°K

6 3000°K

8 2700°K

SCHERMI

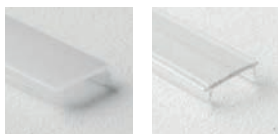

1 Satinato

2 Trasparente

PROFILI TAGLIATI A MISURA INSERITI IN TUBO TRASPARENTE E COMPLETI DI STRIP LED

Il codice del prodotto è riferito a 10 cm di profilo inserito in tubo trasparente e completo di strip led.
Per definire la lunghezza finale del binario considerare la misura di taglio della strip + misura serracavo.

TAILORED CUT PROFILES INSERT IN A CLEAR TUBE AND COMPLETED WITH LED STRIP

The code of the product is referred to 10 cm of it.

To define the final length of the profile consider the cut measure of the strip + measure of the cablestopping.

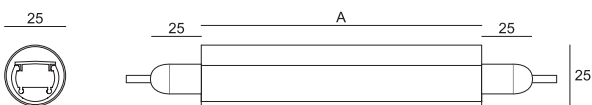

A = max cm 300

Led CRI >90 **A** CE IP 67

OMEGA

Design Athena

Profilo in alluminio anodizzato con schermo in policarbonato PMMA.

Anodized aluminium profile complete with polycarbonate screen PMMA.



Code

9599

Color - cm 10

2  Aluminium

SCHERMI

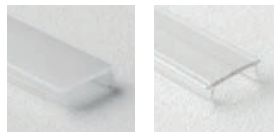

1 Satinato

2 Trasparente

ACCESSORI



Tappo
Dead-end

Code

9551 senza foro

9552 con foro



Supporto parete/soffitto
Wall/ceiling adjustable support

Code

9555



A

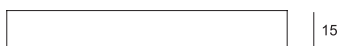

A = max cm 300

Il codice del prodotto è riferito a 10 cm di profilo. In fase d'ordine precisare la misura del profilo richiesta.
Code number refer to 10 cm profile. Ordering, specify the length of the profile request.



DELTA

Design Athena

Profilo in alluminio anodizzato completo di strip LED. Schermo in policarbonato PMMA, cavo alimentazione mm 2000.

Anodized aluminium profile completed with strip LED and polycarbonate PMMA screen. Wire length mm 2000.

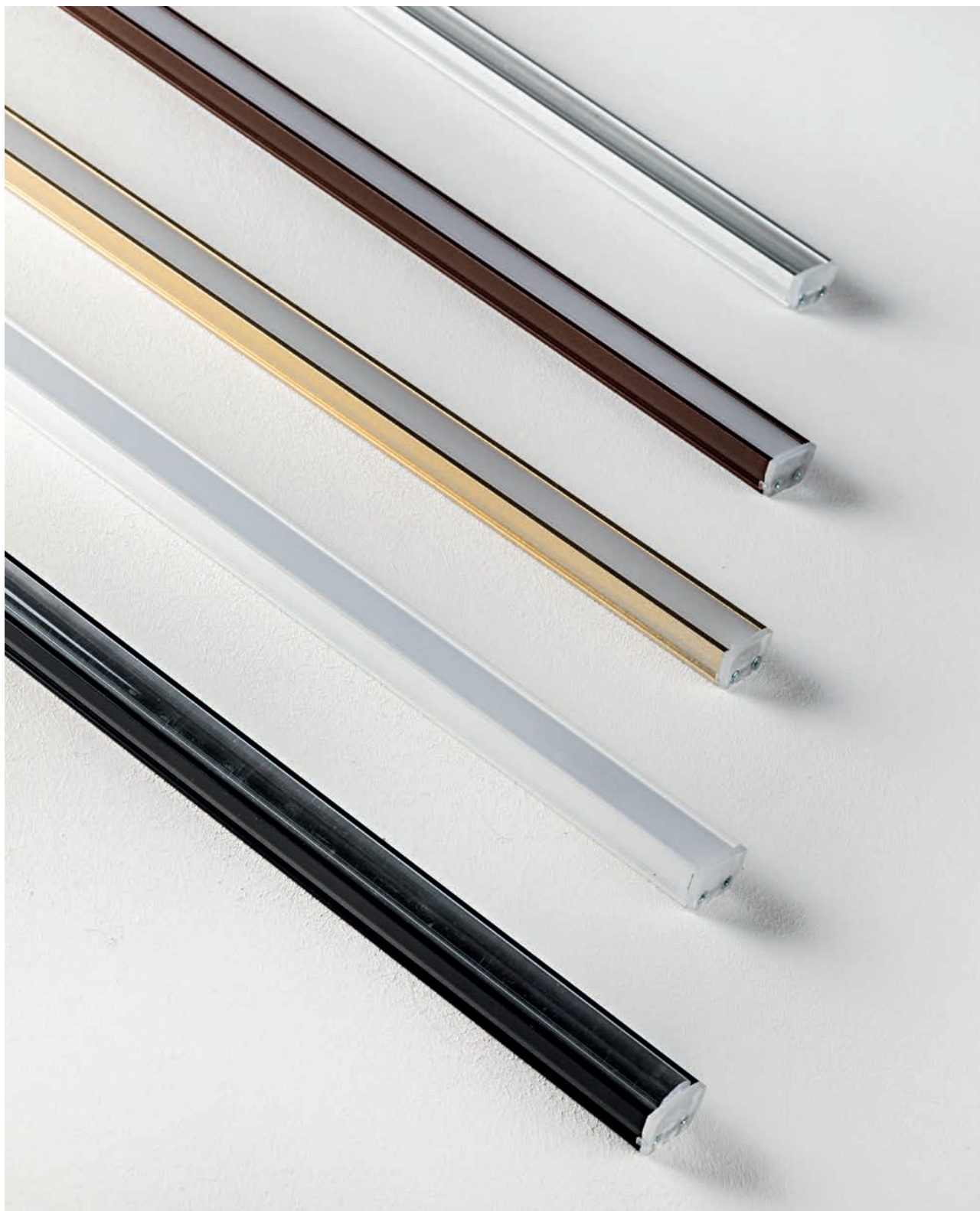

PROFILI TAGLIATI A MISURA PERSONALIZZATA COMPLETI DI LED

Il codice del prodotto è riferito a 10 cm di modulo completo di led. Per definire la lunghezza finale del profilo considerare la misura di taglio del led.

Composizione Codice: modulo cm 270 bianco - 19.2 WW - schermo sat = 9619.5.6.1 cm 270

TAILORED CUT PROFILES WITH LED

The code of the product is referred to 10 cm of it. To define the final length of the profile consider the cut measure of the led.

Code Composition: profile cm 270 - all - 19.2 WW - sat screen = 9619.2.6.1 cm 270

DELTA LED

Design Athena

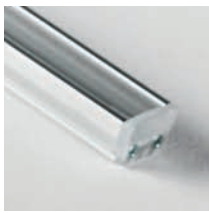

DELTA LED - 14

140 led/mt 14,4 w/mt
Lm/m 1947/1836/1712
24 Vdc CRI90 **A** SDCM3

30.000h $-20^{\circ} + 40^{\circ}$ cm 5

Code - 10 cm

9624

Color

- 2 Aluminium
- 3 Gold
- 4 Corten
- 5 White
- 9 Black

Led

- 1 4000°K
- 6 3000°K
- 8 2700°K

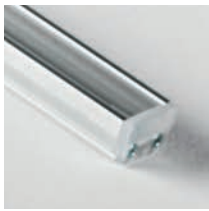

DELTA LED - 19

240 led/mt 19,2 w/mt
Lm/m 1580/1540/1490
24 Vdc CRI90 **A** SDCM3

30.000h $-20^{\circ} + 40^{\circ}$ cm 2,5

Code - 10 cm

9619

Color

- 2 Aluminium
- 3 Gold
- 4 Corten
- 5 White
- 9 Black

Led

- 1 4000°K
- 6 3000°K
- 8 2700°K



DELTA LED - 20

224 led/mt 20,2 w/mt
Lm/m 3114/2937/2740
24 Vdc CRI90 **A** SDCM3

30.000h $-20^{\circ} + 40^{\circ}$ cm 3,57

Code - 10 cm

9621

Color

- 2 Aluminium
- 3 Gold
- 4 Corten
- 5 White
- 9 Black

Led

- 1 4000°K
- 6 3000°K
- 8 2700°K

SCHERMI



- 1 Satinato
- 2 Trasparente
- 3 Lente 40°/Trasp.

ACCESSORI Dettagli pag 47

- 9654**
Kit
sospensione
- 9655**
Supporto
orientabile
- 9656**
Supporto
fisso
- 9661**
Supporto
calamita
- 9662**
Supporto
sbalzo

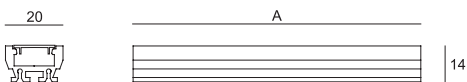

A: Color 2 max cm 400 - 4-5-9 max cm 300 - 3 max cm 200

Led CRI >90 **A** CE IP 40

DELTA LED TOUCH

Delta LED con interruttore dimmerabile touch - Potenza massima 60W.

Delta LED with dimmable touch switch (max 60W).



DELTA LED TOUCH - 14

140 led/mt 14,4 w/mt
Lm/m 1947/1836/1712
24 Vdc CRI90 **A** SDCM3

30.000h -20° +40° cm 5

Code - 10 cm

96824

Color

2 Aluminium
3 Gold
4 Corten
5 White
9 Black

Led

1 4000°K
6 3000°K
8 2700°K



DELTA LED TOUCH - 19

240 led/mt 19,2 w/mt
Lm/m 1580/1540/1490
24 Vdc CRI90 **A** SDCM3

30.000h -20° +40° cm 2,5

Code - 10 cm

96819

Color

2 Aluminium
3 Gold
4 Corten
5 White
9 Black

Led

1 4000°K
6 3000°K
8 2700°K

DELTA LED MOVE

Delta LED con sensore di presenza (rilevazione max 3 mt. - 120° - max 140W).

Delta LED with presence detector (detection max 3 mt. - 120° - max 140W).



DELTA LED MOVE - 10

120 led/mt 9,6 w/mt
Lm/m 887/837
24 Vdc CRI80 **A** SDCM3

30.000h -20° +40° cm 5

Code - 10 cm

96710

Color

2 Aluminium
3 Gold
4 Corten
5 White
9 Black

Led

1 4000°K
6 3000°K



DELTA LED MOVE - 14

140 led/mt 14,4 w/mt
Lm/m 1947/1836/1712
24 Vdc CRI90 **A** SDCM3

30.000h -20° +40° cm 5

Code - 10 cm

96724

Color

2 Aluminium
3 Gold
4 Corten
5 White
9 Black

Led

1 4000°K
6 3000°K
8 2700°K

ACCESSORI Dettagli pag 47

9662 Supporto a sbalzo
9661 Supporto magnete
9656 Supporto fisso
9655 Supporto orientabile
9654 Kit sospensione

DELTA TOUCH

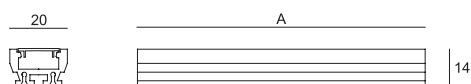

DELTA MOVE

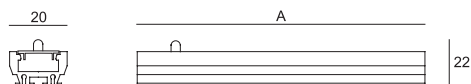

A: Color 2 max cm 400 - 4-5-9 max cm 300 - 3 max cm 200

Led CRI >90 **A** CE IP 40

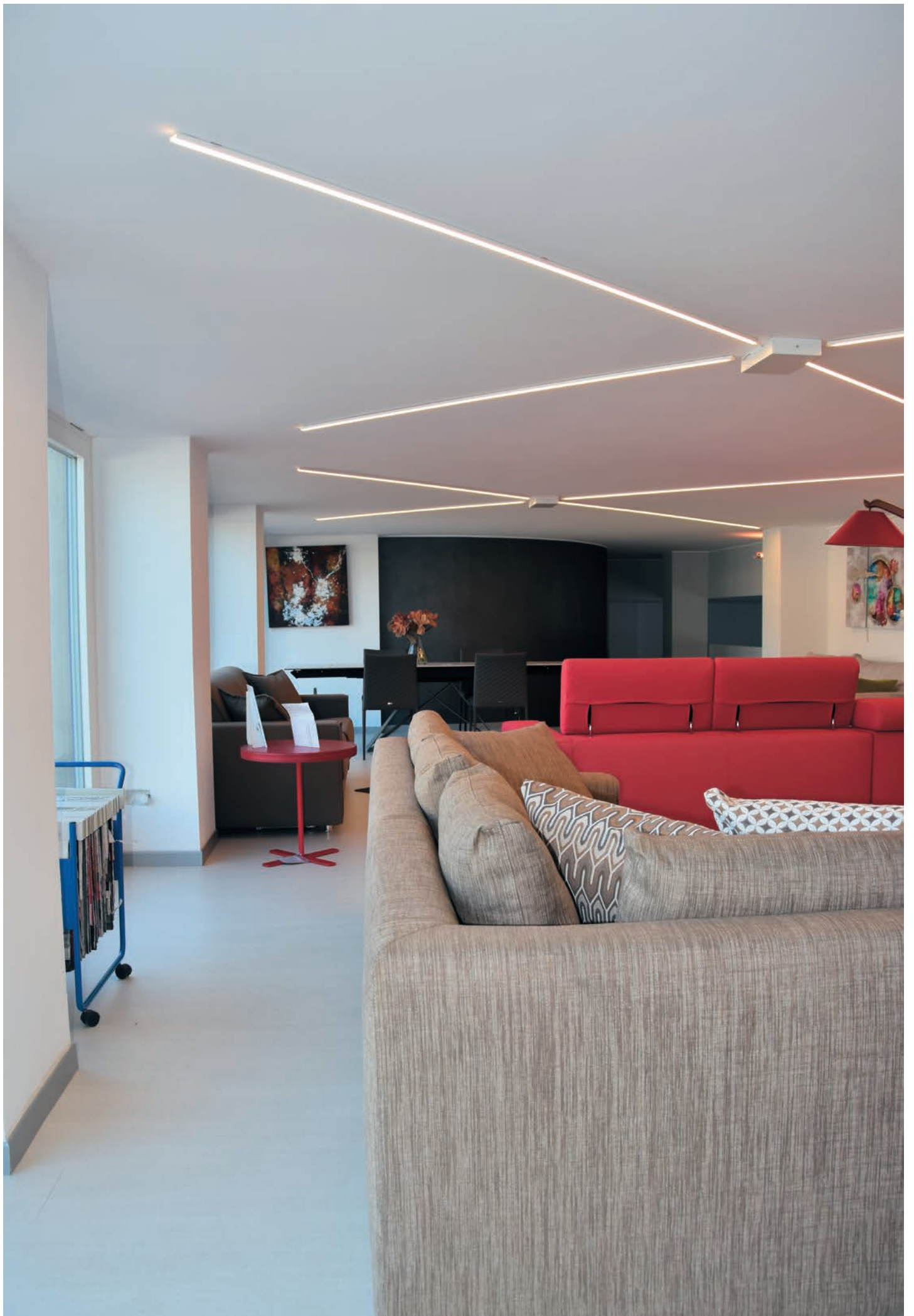

DELTA

Design Athena

Profilo in alluminio anodizzato con schermo in policarbonato PMMA.

Anodized aluminium profile complete with polycarbonate screen PMMA.



Code - cm 10

9699

Color

- | | |
|---|-----------|
| 2 | Aluminium |
| 3 | Gold |
| 4 | Corten |
| 5 | White |
| 9 | Black |

SCHERMI

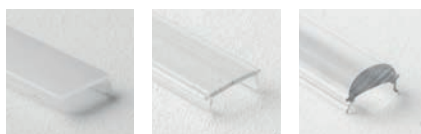

- 1 Satinato 2 Trasparente 3 Lente 40/ trasp.

ACCESSORI



Tappo
Dead-end

Code

9651 senza foro

9652 con foro



Angolo 90° verticale
90° vertical corner

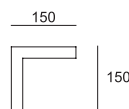

Code

9649



Color

- | | |
|---|-----------|
| 2 | Aluminium |
| 3 | Gold |
| 4 | Corten |
| 5 | White |
| 9 | Black |

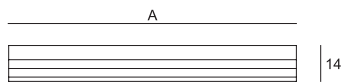









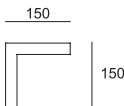

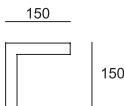









A: Color 2 max cm 400 - 4-5-9 max cm 300 - 3 max cm 200

Il codice del prodotto è riferito a 10 cm di profilo. In fase d'ordine precisare la misura del profilo richiesta.

Code number refer to 10 cm profile. Ordering, specify the length of the profile request.

ACCESSORI DELTA

	Angolo 90° orizzontale 90° horizontal corner		Code	Color										
	Angolo 90° orizzontale 90° horizontal corner		9650 	<table border="0"> <tr><td>2</td><td>Aluminium</td></tr> <tr><td>3</td><td>Gold</td></tr> <tr><td>4</td><td>Corten</td></tr> <tr><td>5</td><td>White</td></tr> <tr><td>9</td><td>Black</td></tr> </table>	2	Aluminium	3	Gold	4	Corten	5	White	9	Black
2	Aluminium													
3	Gold													
4	Corten													
5	White													
9	Black													
	Lavorazione taglio ad angolo 45° dei profili 45° cutting of the profiles		9660											
	Elemento di congiunzione meccanico Straight mechanical connector		9653 											
	Elemento di congiunzione meccanico per angolo 90° orizzontale Mechanical connector for horizontal corner 90°		9657 											
	Elemento di congiunzione meccanico per angolo 90° verticale Mechanical connector for vertical corner 90°		9658 											
	Supporto per sospensione H 2000 mm Suspension kit H 2000 mm		9654 											
	Supporto parete/soffitto orientabile Wall/ceiling adjustable kit		9655 											
	Supporto parete/soffitto Wall/ceiling kit		9656 											
	Supporto a magnete Magnet support		9661 											
	Supporto parete/soffitto a sbalzo Wall/ceiling cantilever support		9662 											

TAU

Design Athena

Profilo in alluminio anodizzato angolare completo di strip LED. Schermo in policarbonato PMMA, cavo alimentazione mm 2000.

Anodized aluminium profile complete with strip LED. Polycarbonate screen PMMA, wire length mm 2000.



PROFILI TAGLIATI A MISURA PERSONALIZZATA COMPLETI DI LED

Il codice del prodotto è riferito a 10 cm di modulo completo di led. Per definire la lunghezza finale del profilo considerare la misura di taglio del led.

Composizione Codice: modulo cm 270 bianco - 19.2 WW - schermo sat = 9119.5.6.1 cm 270

TAILORED CUT PROFILES WITH LED

The code of the product is referred to 10 cm of it. To define the final length of the profile consider the cut measure of the led.

Code Composition: profile cm 270 - all - 19.2 WW - sat screen = 9119.2.6.1 cm 270

TAU LED

Design Athena

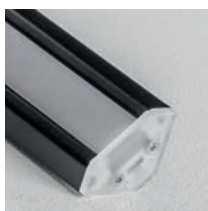

TAU LED - 14

140 led/mt 14,4 w/mt
Lm/m 1947/1836/1712
24 Vdc CRI90 **A** SDCM3

30.000h -20° +40° cm 5

Code - 10 cm

9124

Color

- 2 Aluminium
- 5 White
- 9 Black

Led

- 1 4000°K
- 6 3000°K
- 8 2700°K

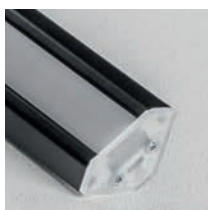

TAU LED - 19

240 led/mt 19,2 w/mt
Lm/m 1580/1540/1490
24 Vdc CRI90 **A** SDCM3

30.000h -20° +40° cm 2,5

Code - 10 cm

9119

Color

- 2 Aluminium
- 5 White
- 9 Black

Led

- 1 4000°K
- 6 3000°K
- 8 2700°K

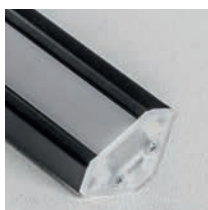

TAU LED - 20

224 led/mt 20,2 w/mt
Lm/m 3114/2937/2740
24 Vdc CRI90 **A** SDCM3

30.000h -20° +40° cm 3,57

Code - 10 cm

9121

Color

- 2 Aluminium
- 5 White
- 9 Black

Led

- 1 4000°K
- 6 3000°K
- 8 2700°K

SCHERMI



1 Satinato

2 Trasparente

ACCESSORI Dettagli pag 53

9656
Supporto
fisso

9661
Supporto
calamita

9662
Supporto
sbalzo

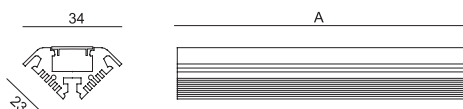

A: Color: 2 max cm 400 - 5-9 max cm 300

Led CRI >90 **A** CE IP 40

TAU LED TOUCH

Tau LED con interruttore dimmerabile touch - Potenza massima 60W.

Tau LED with dimmable touch switch (max 60W).

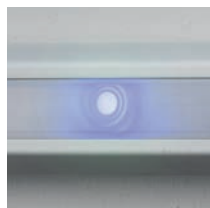

TAU LED TOUCH - 14

140 led/mt 14,4 w/mt
Lm/m 1947/1836/1712
24 Vdc CRI90 **A** SDCM3

30.000h -20° +40° cm 5

Code - 10 cm

91824

Color

2 Aluminium
5 White
9 Black

Led

1 4000°K
6 3000°K
8 2700°K

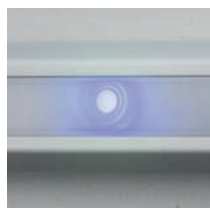

DELTA LED TOUCH - 19

240 led/mt 19,2 w/mt
Lm/m 1580/1540/1490
24 Vdc CRI90 **A** SDCM3

30.000h -20° +40° cm 2,5

Code - 10 cm

91819

Color

2 Aluminium
5 White
9 Black

Led

1 4000°K
6 3000°K
8 2700°K

TAU LED MOVE

Tau LED con sensore di presenza (rilevazione max 3 mt. - 120° - max 140W).

Tau LED with presence detector (detection max 3 mt. - 120° - max 140W).



TAU LED MOVE - 10

120 led/mt 9,6 w/mt
Lm/m 887/837
24 Vdc CRI80 **A** SDCM3

30.000h -20° +40° cm 5

Code - 10 cm

91710

Color

2 Aluminium
5 White
9 Black

Led

1 4000°K
6 3000°K



DELTA LED MOVE - 14

140 led/mt 14,4 w/mt
Lm/m 1947/1836/1712
24 Vdc CRI90 **A** SDCM3

30.000h -20° +40° cm 5

Code - 10 cm

91724

Color

2 Aluminium
5 White
9 Black

Led

1 4000°K
6 3000°K
8 2700°K

TAU LED TOUCH

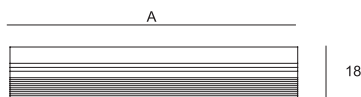
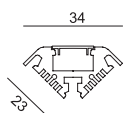

TAU LED MOVE

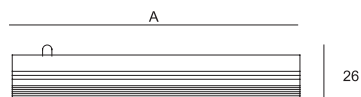
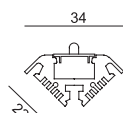

A: Color 2 max cm 400 - 5-9 max cm 300

Led CRI 90 **A** CE IP 40



TAU

Design Athena

Profilo angolare in alluminio anodizzato con schermo in policarbonato.

Anodized aluminium profile with polycarbonate screen.



Code

9199

Color

- 2 Aluminium
- 5 White
- 9 Black

SCHERMI

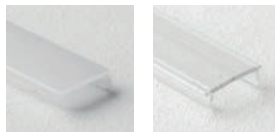

1 Satinato

2 Trasparente

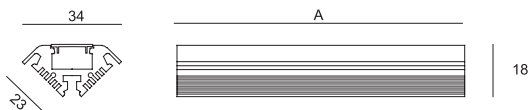

A = Color **2** max cm 400 - **5-9** max cm 300

Il codice del prodotto è riferito a 10 cm di profilo. In fase d'ordine precisare la misura del profilo richiesta.

Code number refer to 10 cm profile. Ordering, specify the length of the profile request.

ACCESSORI TAU



Tappo
Dead-end

Code _____

9151 senza foro

9152 con foro



2



Elemento di congiunzione meccanico
Straight mechanical connector

Code _____

9653



0,8



Supporto parete/soffitto
Wall/ceiling kit

Code _____

9656



1,50



Lavorazione taglio ad angolo 45° dei profili
45° cutting of the profiles

Code _____

9660



Supporto a magnete
Magnet support

Code _____

9661



13



Supporto parete/soffitto a sbalzo
Wall/ceiling cantilever support

Code _____

9662



74

SIHON

Design Athena

Profilo in alluminio anodizzato completo di strip led. Installazione a parete, soffitto e ad incasso.
Schermo in policarbonato satinato: a richiesta schermo trasparente. Cavo di alimentazione rosso/nero mm500.

Anodized aluminium profile complete with strip led. Wall, ceiling and recessed installation. Satined polycarbonate screen: clear screen on demand. Red/black mm500 cable.

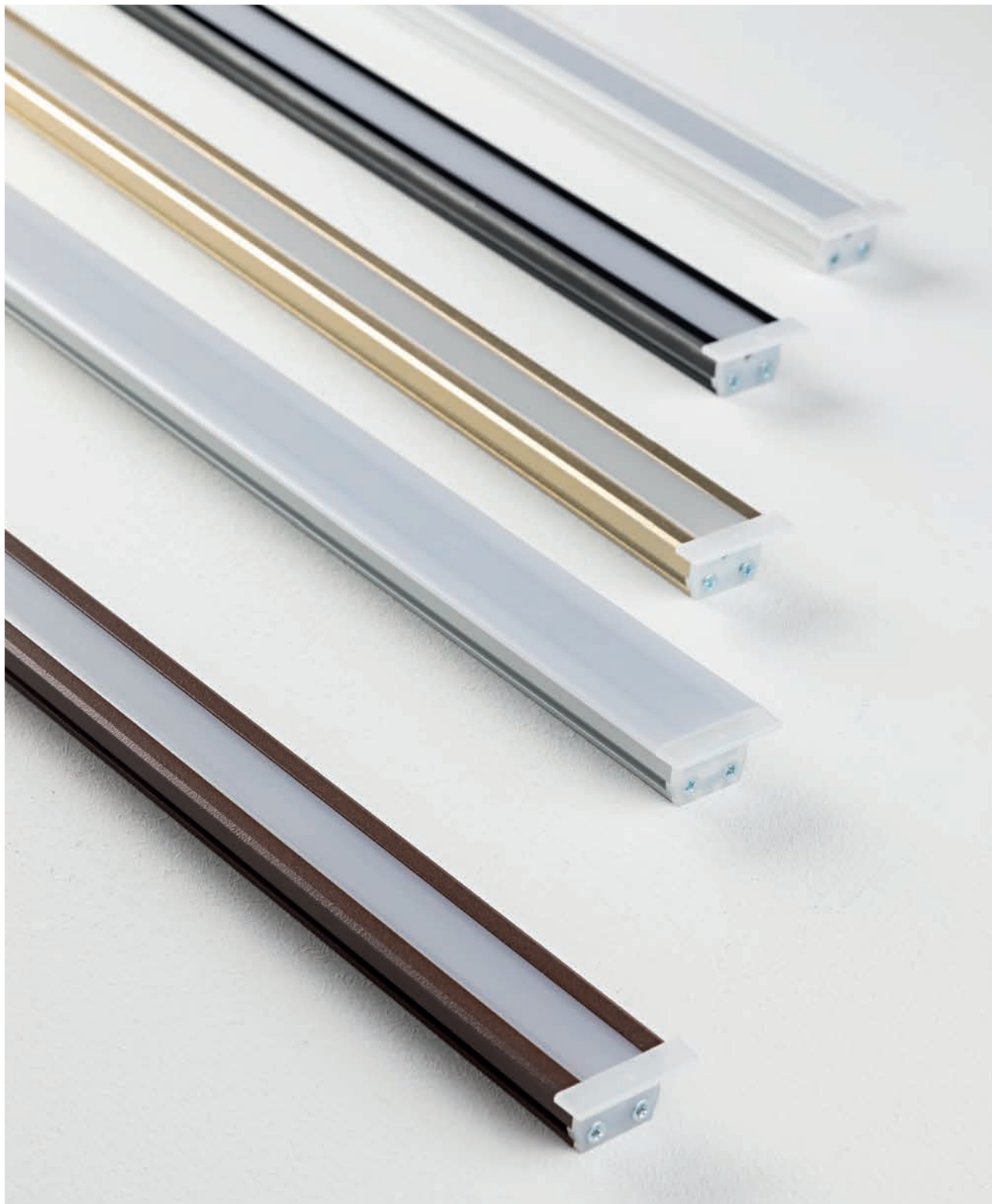

PROFILI TAGLIATI A MISURA PERSONALIZZATA COMPLETI DI LED

Il codice del prodotto è riferito a 10 cm di modulo completo di led. Per definire la lunghezza finale del profilo considerare la misura di taglio del led.

Composizione Codice: modulo cm 270 bianco - 19.2 NW - schermo sat = 9319.5.1.1 cm 270

TAILORED CUT PROFILES WITH LED

The code of the product is referred to 10 cm of it. To define the final length of the profile consider the cut measure of the led).

Code Composition: profile cm 270 - all - 19.2 WW - sat screen = 9319.2.6.1 cm 270

SIHON LED

Design Athena



SIHON LED - 14

140 led/mt 14,4 w/mt
Lm/m 1947/1836/1712
24 Vdc CRI90 **A** SDCM3

30.000h -20° +40° cm 5

Code - 10 cm

9324

Color

- 2 Aluminium
- 3 Gold
- 4 Corten
- 5 White
- 9 Black

Led

- 1 4000°K
- 6 3000°K
- 8 2700°K



SIHON LED - 19

240 led/mt 19,2 w/mt
Lm/m 1580/1540/1490
24 Vdc CRI90 **A** SDCM3

30.000h -20° +40° cm 2,5

Code - 10 cm

9319

Color

- 2 Aluminium
- 3 Gold
- 4 Corten
- 5 White
- 9 Black

Led

- 1 4000°K
- 6 3000°K
- 8 2700°K



SIHON LED - 20

224 led/mt 20,2 w/mt
Lm/m 3114/2937/2740
24 Vdc CRI90 **A** SDCM3

30.000h -20° +40° cm 3,57

Code - 10 cm

9321

Color

- 2 Aluminium
- 3 Gold
- 4 Corten
- 5 White
- 9 Black

Led

- 1 4000°K
- 6 3000°K
- 8 2700°K

SCHERMI



1 Satinato S
L28

2 Satinato D
L14

ACCESSORI Dettagli pag 59

- 9656** Supporto fisso
- 9655** Supporto orientabile
- 9654** Kit sospensione
- 9661** Supporto calamita
- 9662** Supporto sbalzo

ACCESSORI PER INCASSO Dettagli pag 60-61

- 930549** Controcassa curva oriz.
- 930550** Controcassa curva vert.
- 930599** Controcassa per incasso
- 9353** Molla per incasso
- 9354** Molla a pressione

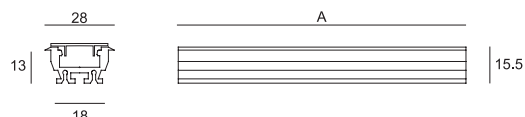

A = Color: **2** max cm 400 - **4-5-9** max cm 300 - **3** max cm 200

Led CRI >90 **A** CE IP 40

SIHON LED TOUCH

Sihon LED con interruttore dimmerabile touch - Potenza massima 60W.

Sihon LED with dimmable touch switch (max 60W).

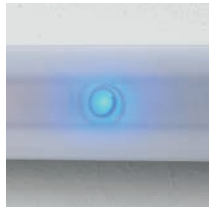

SIHON LED TOUCH - 14

140 led/mt 14,4 w/mt
Lm/m 1947/1836/1712
24 Vdc CRI90 **A** SDCM3

30.000h -20°+40° cm 5

Code - 10 cm

93824

Color

2 Aluminium
3 Gold
4 Corten
5 White
9 Black

Led

1 4000°K
6 3000°K
8 2700°K

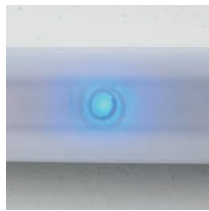

SIHON LED TOUCH - 19

240 led/mt 19,2 w/mt
Lm/m 1580/1540/1490
24 Vdc CRI90 **A** SDCM3

30.000h -20°+40° cm 2,5

Code - 10 cm

93819

Color

2 Aluminium
3 Gold
4 Corten
5 White
9 Black

Led

1 4000°K
6 3000°K
8 2700°K

SIHON LED MOVE

Sihon LED con sensore di presenza (rilevazione max 3 mt. - 120° - max 140W).

Sihon LED with presence detector (detection max 3 mt. - 120° - max 140W).



SIHON LED MOVE - 10

120 led/mt 9,6 w/mt
Lm/m 800/780
24 Vdc CRI80 **A** SDCM3

30.000h -20°+40° cm 5

Code - 10 cm

93710

Color

2 Aluminium
5 White
9 Black

Led

1 4000°K
6 3000°K



SIHON LED MOVE - 14

140 led/mt 14,4 w/mt
Lm/m 1947/1836/1712
24 Vdc CRI90 **A** SDCM3

30.000h -20°+40° cm 5

Code - 10 cm

93724

Color

2 Aluminium
3 Gold
4 Corten
5 White
9 Black

Led

1 4000°K
6 3000°K
8 2700°K

ACCESSORI Dettagli pag 59

9656
Supporto
fisso

9655
Supporto
orientabile

9661
Supporto
calamita

9662
Supporto
sbalzo

9353
Molla
per incasso

9354
Molla
a pressione

SIHON LED TOUCH

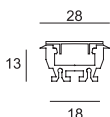

SIHON LED MOVE

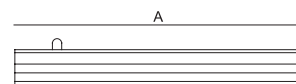
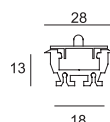

A = Color **2** max cm 400 - **4-5-9** max cm 300 - **3** max cm 200

Led CRI 90 **A** CE IP 40

OHANA | *Cafe*



SIHON

Design Athena

Profilo in alluminio anodizzato con schermo in policarbonato satinato, installazione anche ad incasso.





Anodized aluminium recessed profile complete with satined polycarbonate screen.



Code - 10 cm

Color

9399

2		Aluminium
3		Gold
4		Corten
5		White
9		Black

SCHERMI



1 Satinato S

2 Satinato D

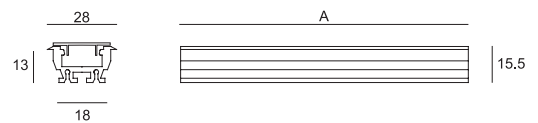











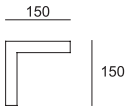







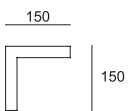





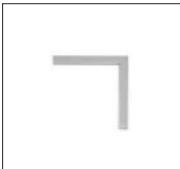



A = Color: **2** max cm 400 - **4-5-9** max cm 300 - **3** max cm 200

Il codice del prodotto è riferito a 10 cm di profilo. In fase d'ordine precisare la misura del profilo richiesta.

Code number refer to 10 cm profile. Ordering, specify the length of the profile request.

ACCESSORI SIHON

	Tappo Dead-end		Code 9352	
			 0,6	
	Angolo 90° verticale 90° vertical corner		Code 9349	Color
			 60	2  Aluminium 3  Gold 4  Corten 5  White 9  Black
	Angolo 90° orizzontale 90° horizontal corner		Code 9350	Color
			 60	2  Aluminium 3  Gold 4  Corten 5  White 9  Black
	Lavorazione taglio ad angolo 45° dei profili 45° cutting of the profiles		Code 9660	
	Elemento di congiunzione meccanico Straight mechanical connector		Code 9653	
			 0,8	
	Elemento di congiunzione meccanico per angolo 90° orizzontale Mechanical connector for horizontal corner 90°		Code 9657	
			 0,8	
	Elemento di congiunzione meccanico per angolo 90° verticale Mechanical connector for vertical corner 90°		Code 9658	
			 0,80	
	Supporto per sospensione H 2000 mm Suspension kit H 2000 mm		Code 9654	
			 155	
	Supporto parete/soffitto Wall/ceiling kit		Code 9656	
			 1,50	
	Supporto parete/soffitto a sbalzo Wall/ceiling cantilever support		Code 9662	
			 72	

ACCESSORI SIHON



Supporto parete/soffitto orientabile
Wall/ceiling kit

Code

9655

Molla per incasso controsoffitto e controcassa
Foro incasso larghezza 19 mm:
Posizionare inizio-fine +1 ogni 50 cm.
Spring for recessed ceiling. Recessed hole width 19 mm.
Place: beginning, end and 1 every 50 cm

Code

9353

Molla a pressione
Foro incasso larghezza 19 mm:
Posizionare inizio-fine +1 ogni 50 cm.
Spring for recessed ceiling. Recessed hole width 19 mm.
Place: beginning, end and 1 every 50 cm

Code

9354

Supporto a calamita.
Posizionare inizio-fine +1 ogni 50 cm.
Magnet support.
Place: beginning, end and 1 every 50 cm

Code

9661

ACCESSORI SIHON



Controcassa curva orizzontale
per incasso murature e laterizio.
Horizontal corner casing for brickwork.

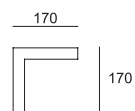

Code

930549



Controcassa curva verticale
per incasso murature e laterizio.
Vertical corner casing for brickwork.

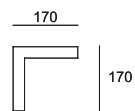

Code

930550



Controcassa per incasso murature e laterizio.
Casing for brickwork.

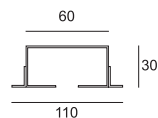

Code - cm 10

930599



B-LIGHT

Design Athena

Profilo in alluminio anodizzato disponibile nelle finiture alluminio, bianco e corten. Lo spessore ridotto del profilo e la possibilità di inserire due linee di luce bi-direzionale ne permettono l'utilizzo in tutti gli ambienti creando una illuminazione diffusa e d'effetto.

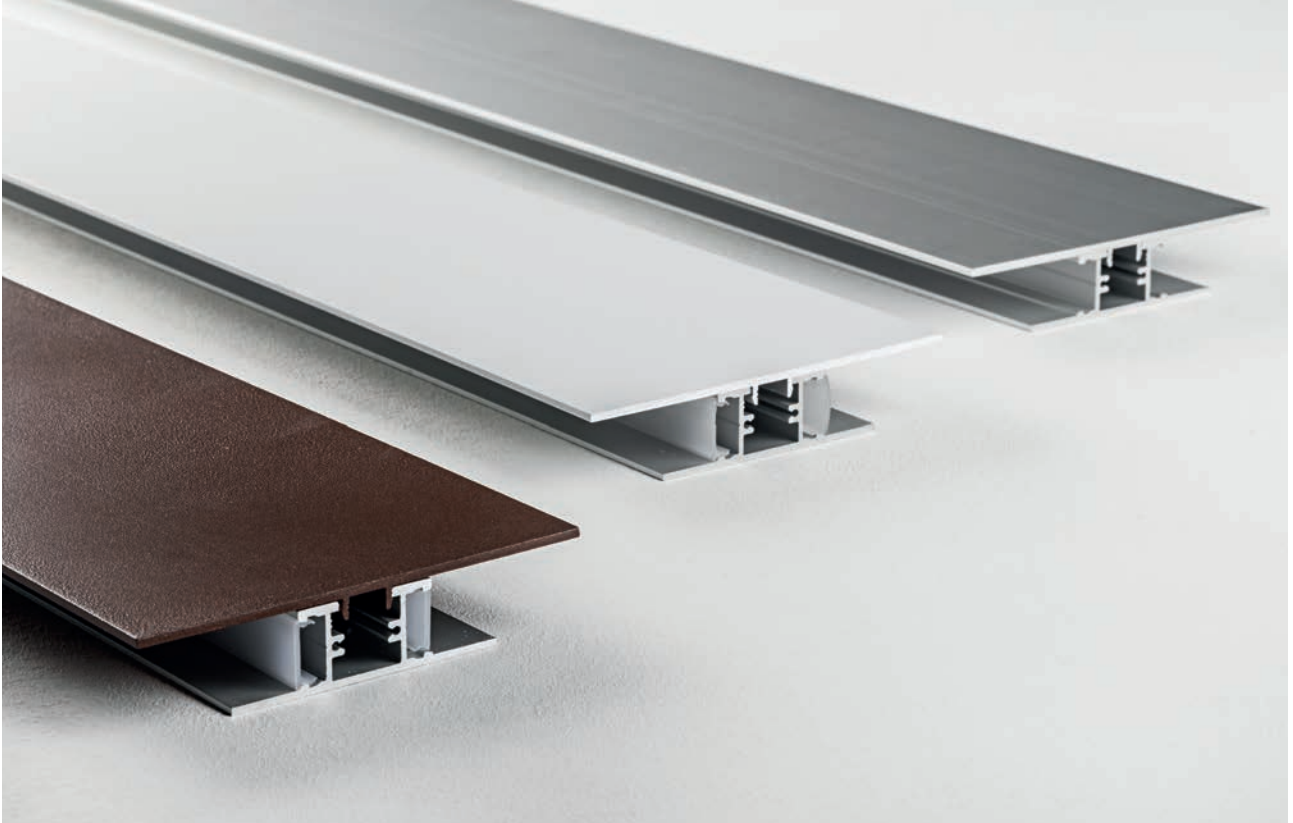
Anodized aluminium profile available in aluminium, White and Corten finishings. The reduced thickness of the profile and the possibility to insert two lines of bidirectional light, allow the usage of it in every location, creating a diffused and impressive lighting.







Code	Color
9493	2  Aluminium
	4  Corten max
	5  White max

ACCESSORI



Tappo
Dead-end

Code	Color
9456	2  Aluminium
	4  Corten
	5  White

 50

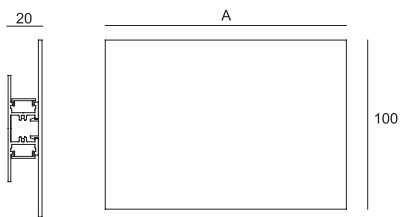

max cm 200

Il codice del prodotto è riferito a 10 cm di profilo. In fase d'ordine precisare la misura del profilo richiesta.
Code number refer to 10 cm profile. Ordering, specify the length of the profile request.



MICRO

Design Athena

Profilo in alluminio anodizzato completo di strip led. Schermo in policarbonato. Cavo alimentazione mm 2000.

Anodized aluminium profile complete with strip led. Polycarbonate screen. Cable mm 2000.



PROFILI TAGLIATI A MISURA PERSONALIZZATA COMPLETI DI LED

Il codice del prodotto è riferito a 10 cm di modulo completo di led. Per definire la lunghezza finale del profilo considerare la misura di taglio del led.

Composizione Codice: modulo cm 270 bianco - 19.2 WW - schermo sat = 949519.2.1.1 cm 270

TAILORED CUT PROFILES WITH LED

The code of the product is referred to 10 cm of it. To define the final length of the profile consider the cut measure of the led.

Code Composition: profile cm 270 - all - 19.2 WW - sat screen = 949519.2.1.1 cm 270

MICRO LED

Design Athena

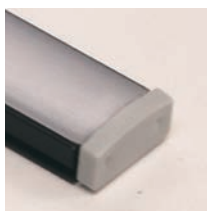

MICRO LED - 14

140 led/mt 14,4 w/mt
Lm/m 1947/1836/1712
24 Vdc CRI90 **A** SDCM3

30.000h $-20^{\circ} + 40^{\circ}$ cm 5

Code - 10 cm

949524

Color

- 2 Aluminium
- 5 White
- 9 Black

Led

- 1 4000°K
- 6 3000°K
- 8 2700°K

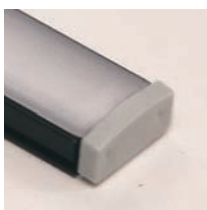

MICRO LED - 19

240 led/mt 19,2 w/mt
Lm/m 1580/1540/1490
24 Vdc CRI90 **A** SDCM3

30.000h $-20^{\circ} + 40^{\circ}$ cm 2,5

Code - 10 cm

949519

Color

- 2 Aluminium
- 5 White
- 9 Black

Led

- 1 4000°K
- 6 3000°K
- 8 2700°K

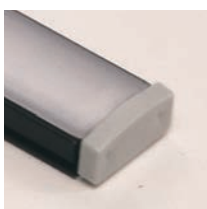

MICRO LED - 20

224 led/mt 20,2 w/mt
Lm/m 3114/2937/2740
24 Vdc CRI90 **A** SDCM3

30.000h $-20^{\circ} + 40^{\circ}$ cm 3,57

Code - 10 cm

949521

Color

- 2 Aluminium
- 5 White
- 9 Black

Led

- 1 4000°K
- 6 3000°K
- 8 2700°K

SCHERMI



- 1 Satinato
- 2 Trasparente
- 3 Lente 40°/Trasp.

ACCESSORI Dettagli pag 67

9656
Supporto
fisso



A: Color: **2** max cm 400 - **5-9** max cm 300 - **3** max cm 200

Led CRI >90 **A** CE IP 40

MICRO

Design Athena

Profilo in alluminio anodizzato con schermo in policarbonato.

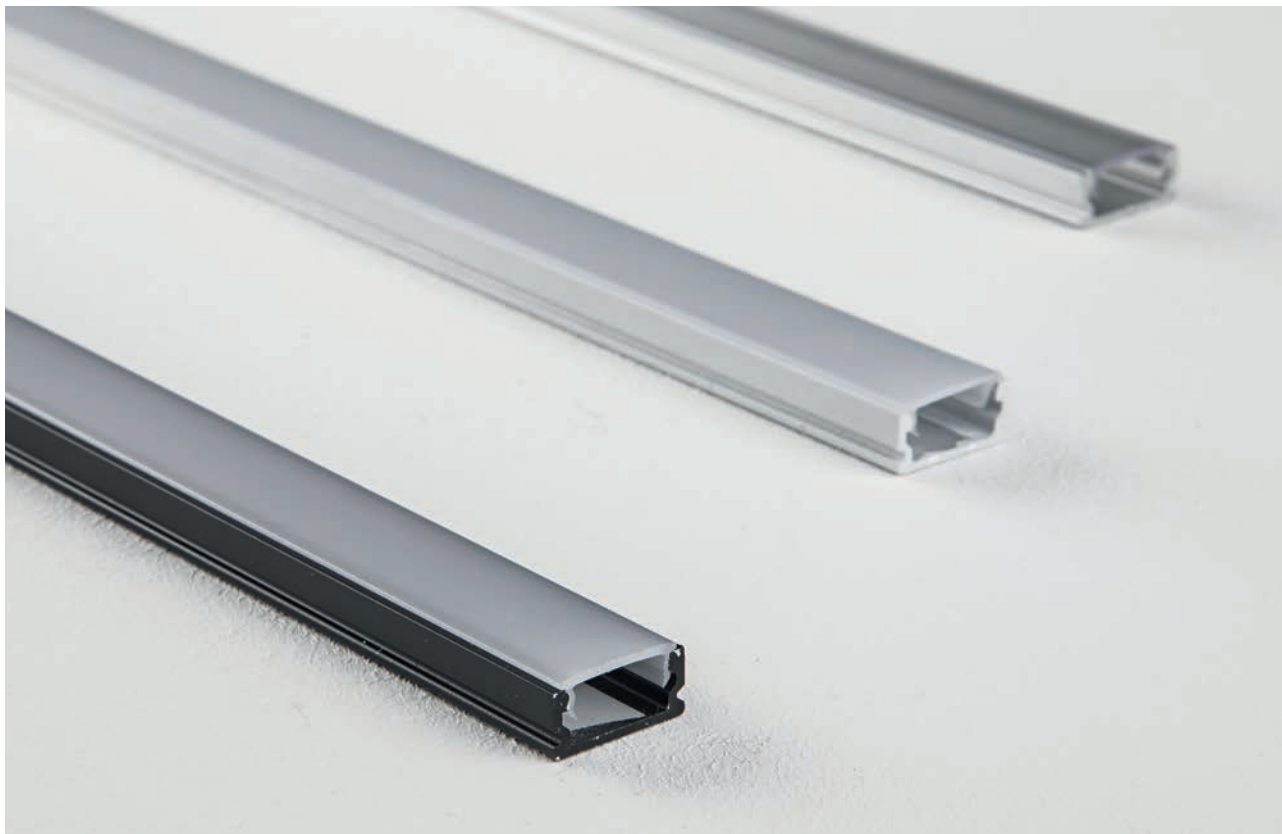

Anodized aluminium profile complete with polycarbonate screen.



Code - 10 cm

Color

9495

- 2  Aluminium
- 5  White
- 9  Black

SCHERMI



1 Satinato

2 Trasparente

3 Lente 40°/Trasp.

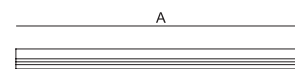

A = max cm 300

| 10

Il codice del prodotto è riferito a 10 cm di profilo. In fase d'ordine precisare la misura del profilo richiesta.

Code number refer to 10 cm profile. Ordering, specify the length of the profile request.



ACCESSORI MICRO



Tappo
Dead-end

Code _____

9453 senza foro

9454 con foro



Lavorazione taglio ad angolo 45° dei profili
45° cutting of the profiles

Code _____

9660



Supporto parete/soffitto
Wall/ceiling support

Code _____

9656



VELA

Design Athena

Profilo in estruso di alluminio anodizzato. Utilizzabile per applicazioni con cartongesso e adatto per installazioni perimetrali.

Extruded profile in anodized aluminium. It can be used for drywall applications and it is suitable for perimeter installations.

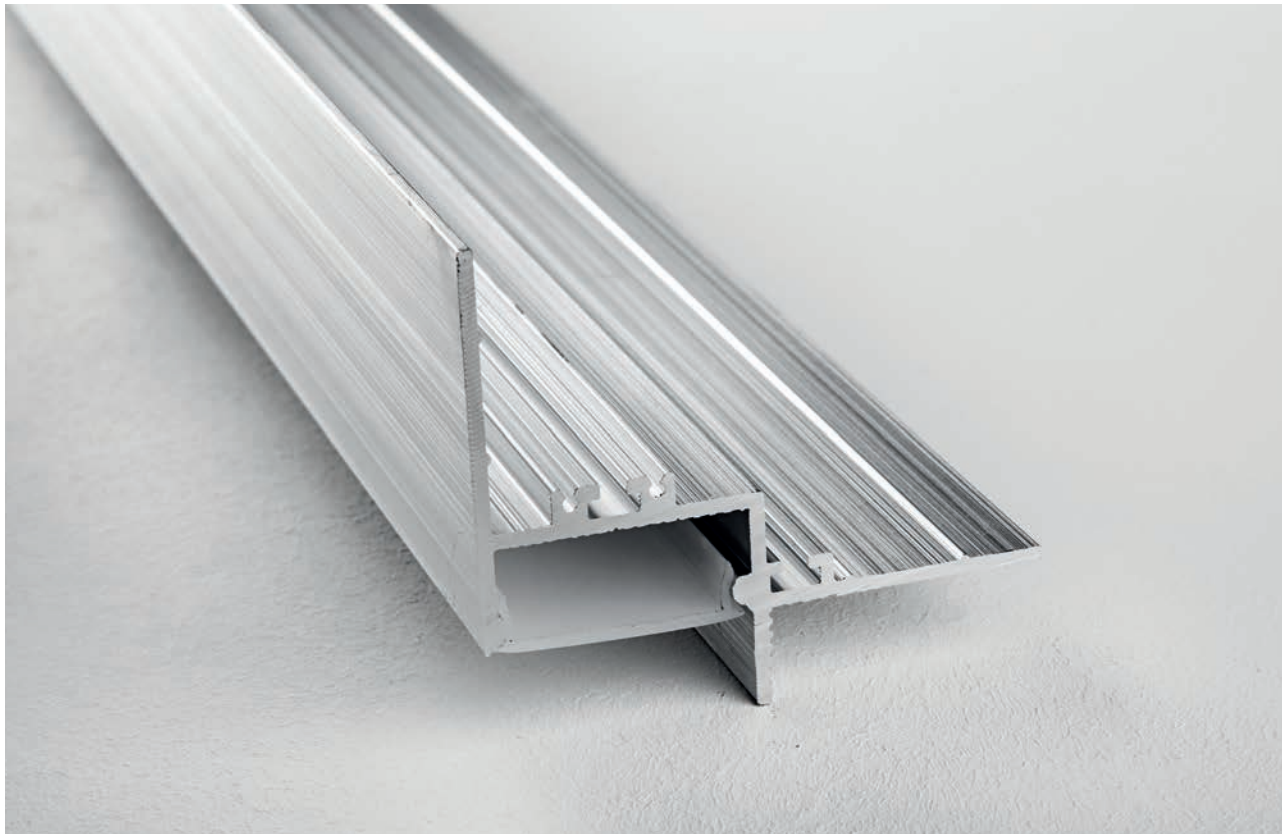

Code - 10 cm

Color

9494

2 Aluminium

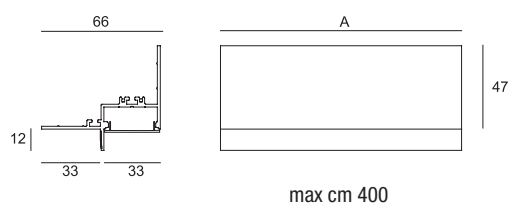

Il codice del prodotto è riferito a 10 cm di profilo. In fase d'ordine precisare la misura del profilo richiesta.
Code number refer to 10 cm profile. Ordering, specify the length of the profile request.

ACCESSORI VELA



Tappo
Dead-end

Code

9455



Elemento di congiunzione meccanico
Straight mechanical connector

Code

9653



Elemento di congiunzione meccanico per angolo 90° orizzontale
Mechanical connector for horizontal corner 90°

Code

9657



Schema di installazione
Installation scheme

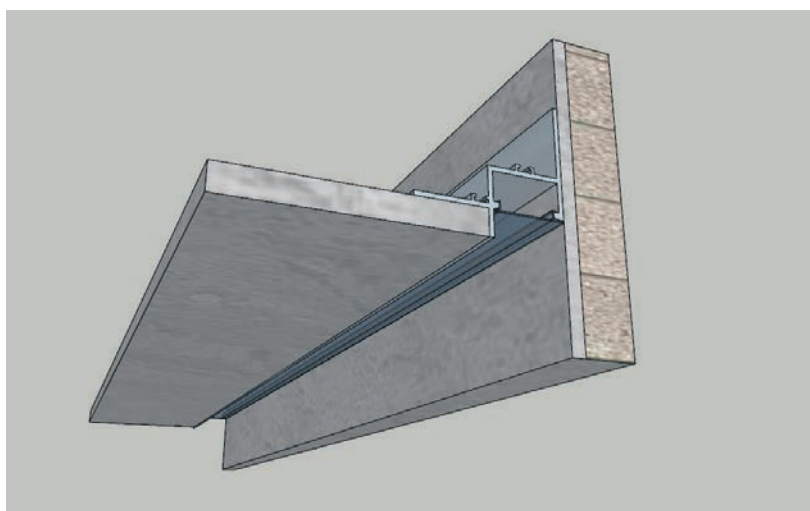

KAPPA

Design Athena

Profilo in alluminio anodizzato con schermo in policarbonato.

Anodized aluminium profile complete with polycarbonate screen.



Code - 10 cm

Color

SCHERMI

9499

2  Aluminium



1 Satinato



2 Trasparente



3 Lente 40/ trasp.

ACCESSORI

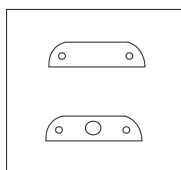

Tappo
Dead-end

Code

9451 senza foro

9452 con foro



2

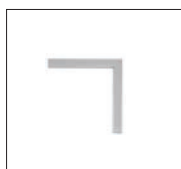

Lavorazione taglio
ad angolo 45° dei profili
45° cutting of the profiles

Code

9660



60



max cm 300

Il codice del prodotto è riferito a 10 cm di profilo. In fase d'ordine precisare la misura del profilo richiesta.

Code number refer to 10 cm profile. Ordering, specify the length of the profile request.

PIATTO

Design Athena

Piatto alluminio per dissipazione del calore.
Aluminium bar for heat dissipation.



Code - 10 cm **Color**

9491 2  Aluminium

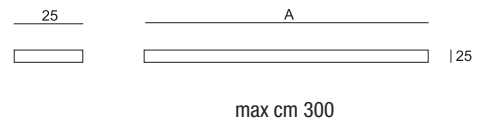

Code - 10 cm **Color**

9492 2  Aluminium

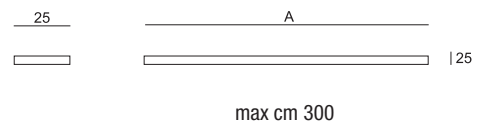

Il codice del prodotto è riferito a 10 cm di profilo. In fase d'ordine precisare la misura del profilo richiesta.
Code number refer to 10 cm profile. Ordering, specify the length of the profile request.

RESINATI IP67

Design Athena

Profilo in alluminio anodizzato completo di strip led e copertura in resina trasparente o satinata. Cavo di alimentazione FROR mm 2000. Grado di protezione IP67. Adatto sia ambienti interni che esterni.

Anodized aluminium profile and completed with led strips and a transparent or satin resin coverage. Power cord FROR mm 2000. Protection degree IP. Suitable for both inters and outdoors.



PROFILI TAGLIATI A MISURA PERSONALIZZATA COMPLETI DI LED

Il codice del prodotto è riferito a 10 cm di modulo completo di led. Per definire la lunghezza finale del profilo considerare la misura di taglio del led.

Composizione Codice: modulo Delta cm 270 bianco - 14,4 WW - schermo sat = 96424.2.6.1 cm 270

TAILORED CUT PROFILES WITH LED

The code of the product is referred to 10 cm of it. To define the final length of the profile consider the cut measure of the led.

Code Composition: profile Delta cm 270 - all - 14.4 WW - sat screen = 96424.2.6.1 cm 270

RESINATI DELTA IP67

Design Athena



RESINATI DELTA - 05

60 led/mt 4,8 w/mt
Lm/m 438/418
24 Vdc CRI80 **A** SDCM3

30.000h -20° +40° cm 10

Code - 10 cm

96405

Color

- 2 Aluminium
- 4 Corten
- 5 White

Led

- 1 4000°K
- 6 3000°K



RESINATI DELTA - 10

120 led/mt 9,6 w/mt
Lm/m 887/837
24 Vdc CRI80 **A** SDCM3

30.000h -20° +40° cm 5

Code - 10 cm

96410

Color

- 2 Aluminium
- 4 Corten
- 5 White

Led

- 1 4000°K
- 6 3000°K



RESINATI DELTA - 14

140 led/mt 14,4 w/mt
Lm/m 1947/1836/1712
24 Vdc CRI90 **A** SDCM3

30.000h -20° +40° cm 5

Code - 10 cm

96424

Color

- 2 Aluminium
- 4 Corten
- 5 White

Led

- 1 4000°K
- 6 3000°K
- 8 2700°K

RESINATURA



- 1 Trasparente
- 2 Satinato bianco

ACCESSORI



Supporto parete/soffitto
Wall/ceiling adjustable support

Code

9656

1,50



Supporto a magnete
Magnet support

Code

9661

13

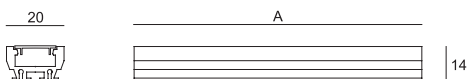

max cm 300

Solo finitura 2

Led CRI >90 **A** CE IP 67

RESINATI SIHON IP67

Design Athena



RESINATI SIHON - 05

60 led/mt 4,8 w/mt
Lm/m 438/418
24 Vdc CRI80 **A** SDCM3

30.000h -20°+40° cm 10

Code - 10 cm

93405

Color

2 Aluminium
4 Corten
5 White

Led

1 4000°K
6 3000°K

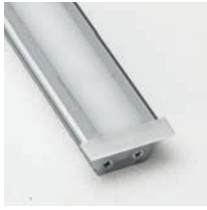

RESINATI SIHON - 10

120 led/mt 9,6 w/mt
Lm/m 887/837
24 Vdc CRI80 **A** SDCM3

30.000h -20°+40° cm 5

Code - 10 cm

93410

Color

2 Aluminium
4 Corten
5 White

Led

1 4000°K
6 3000°K



RESINATI SIHON - 14

140 led/mt 14,4 w/mt
Lm/m 1947/1836/1712
24 Vdc CRI90 **A** SDCM3

30.000h -20°+40° cm 5

Code - 10 cm

93424

Color

2 Aluminium
4 Corten
5 White

Led

1 4000°K
6 3000°K
8 2700°K

RESINATURA



1 Trasparente 2 Satinato bianco

ACCESSORI Dettagli pag 50

9656Supporto
fisso**9661**Supporto
calamita

ACCESSORI PER INCASSO Dettagli pag 60-61

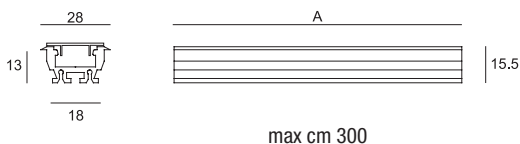
930549Controcassa
curva oriz.**930550**Controcassa
curva vert.**930599**Controcassa
per incasso**9353**Molla
per incasso**9354**Molla
a pressione

Solo finitura 2

Led CRI >90 **A** CE IP 67



ETHA

Design Athena

Profilo CALPESTABILE in alluminio anodizzato. Schermo in policarbonato completo di strip Led e cavo alimentazione mm 2000. Grado di protezione IP67. Adatto per ambienti interni ed esterni

WALKABLE anodized aluminium profile. Polycarbonate complete with strip led and wire lenght mm 2000. Degree of protection IP67. Suitable for indoor and outdoor environments.



Cassaforma senza bordo
Anodized aluminium profile

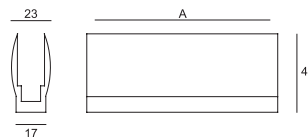

Code - 10 cm

Color

9298

2  Aluminium

Cassaforma con bordo
Anodized aluminium profile

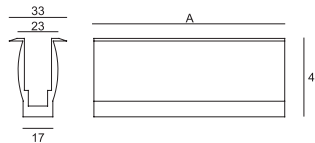

Code - 10 cm

Color

9299

2  Aluminium

Policarbonato con strip led
Polycarbonate with strip led

ETHA - 05

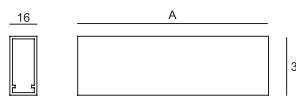

60 led/mt 4,8 w/mt
Lm/m 438/418
24 Vdc CRI80  SDCM3



Code - 10 cm

Led

9205

1  4000°K
6  3000°K

  -20°+40°  cm 10 



ETHA - 10

120 led/mt 9,6 w/mt
Lm/m 887/837
24 Vdc CRI80  SDCM3

Code - 10 cm

Led

9210

1  4000°K
6  3000°K

  -20°+40°  cm 5 

POLICARBONATO TAGLIATO A MISURA COMPLETO DI STRIP LED E CAVO FROR 2x0,50 CM 200

Il codice del prodotto è riferito a 10 cm di modulo completo di led. Per definire la lunghezza finale del binario considerare multipli da 10 cm per strip 4,8w e multipli da 5 cm per strip 9,6w + 4 cm per i tappi di chiusura e il cablaggio.

TAILORED CUT PROFILES COMPLETED WITH LED STRIPS

The code of the product is referred to 10 cm of it. To define the final length of the profile consider multiples of 10 cm for strip 4,8w and multiples of 5 cm for strip 9,6w + 4 cm for the closing tops and the wiring.

Led CRI 75-80   IP 67   



STRIP FLEX 20,2 W/MT 224 LED/MT - CRI 90 - IP 20

Strip led flessibile 20,2 w/mt con biadesivo 3M, cavo alimentazione rosso/nero cm 30.

Flexible 20,2 w/mt strip led, red/black cable cm 30



ROLLA CM 500

224 led/mt 20,2 w/mt - IP 20
CRI90 - SDCM3 - SMD2835
Lm/mt 1-3114 / 6-2937 / 8-2740
24 Vdc - input current 0,84 A/MT

30.000h $-20^{\circ} + 40^{\circ}$ cm 3,57 8 LED

Code

979020

Led

1 4000°K
6 3000°K
8 2700°K



STRIP CM 10

224 led/mt 20,2 w/mt - IP 20
CRI90 - SDCM3 - SMD2835
Lm/mt 1-3114 / 6-2937 / 8-2740
24 Vdc - input current 0,84 A/MT

30.000h $-20^{\circ} + 40^{\circ}$ cm 3,57 8 LED

Code - cm 10

979029

Led

1 4000°K
6 3000°K
8 2700°K

Installare su superfici dissipanti il calore. Applicazione in luoghi asciutti in ambienti interni.

Install only on dissipating surfaces. Application on a dry place indoors.

Il codice è riferito a cm10 - Per definire la lunghezza della strip considerare la misura di taglio del Led

Code is referred to 10cm - To define the final length of the strip consider the cut measure of the Led

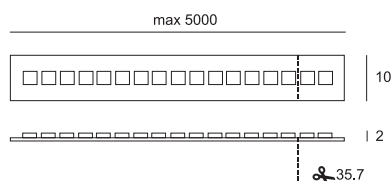

Led CRI 90 **A+** CE IP 20

STRIP FLEX 19,2 W/MT 240 LED/MT - CRI 90 - IP 20

Strip led flessibile 19,2 w/mt con biadesivo 3M, cavo alimentazione rosso/nero cm 30.

Flexible 19,2 w/mt strip led, red/black cable cm 30



ROLLA CM 500
 240 led/mt 19,2 w/mt - IP 20
 CRI90 - SDCM3 - SMD 3528
 Lm/mt 1-1580 / 6-1540 / 8-1490
 24 Vdc - input current 0,8 A/MT

30.000h $-20^{\circ}+40^{\circ}$ cm 2,5 6 LED

Code
979060

Led
 1 4000°K
 6 3000°K
 8 2700°K



STRIP CM 10
 240 led/mt 19,2 w/mt - IP 20
 CRI90 - SDCM3 - SMD 3528
 Lm/mt 1-1580 / 6-1540 / 8-1490
 24 Vdc - input current 0,8 A/MT

30.000h $-20^{\circ}+40^{\circ}$ cm 2,5 6 LED

Code - cm 10
979069

Led
 1 4000°K
 6 3000°K
 8 2700°K

Led CRI 90 **A+** CE IP 20

STRIP FLEX 19,2 W/MT 240 LED/MT - CRI 80 - IP 20

Strip led flessibile 19,2 w/mt con biadesivo 3M, cavo alimentazione rosso/nero cm 30.

Flexible 19,2 w/mt strip led, red/black cable cm 30



ROLLA CM 500
 240 led/mt 19,2 w/mt - IP 20
 CRI80 - SDCM3 - SMD 3528
 Lm/mt 1-1580 / 6-1540 / 8-1490
 24 Vdc - input current 0,8 A/MT

30.000h $-20^{\circ}+40^{\circ}$ cm 2,5 6 LED

Code
9760

Led
 1 4000°K
 6 3000°K
 8 2700°K



STRIP CM 10
 240 led/mt 19,2 w/mt - IP 20
 CRI80 - SDCM3 - SMD 3528
 Lm/mt 1-1580 / 6-1540 / 8-1490
 24 Vdc - input current 0,8 A/MT

30.000h $-20^{\circ}+40^{\circ}$ cm 2,5 6 LED

Code
9769

Led
 1 4000°K
 6 3000°K
 8 2700°K

Installare su superfici dissipanti il calore. Applicazione in luoghi asciutti in ambienti interni.
 Install only on dissipating surfaces. Application on a dry place indoors.

Led CRI 80 **A+** CE IP 20

Il codice è riferito a cm10 - Per definire la lunghezza della strip considerare la misura di taglio del Led
 Code is referred to 10cm - To define the final length of the strip consider the cut measure of the Led

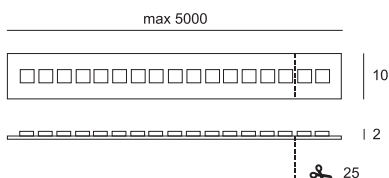

STRIP FLEX DYNAMIC White 120 LED/MT - CRI 80 - IP 20

Strip led flessibile con biadesivo 3M, regolazione colore da bianco freddo a bianco caldo.
Flexible strip led, colour from cold to warm white.



ROLLA CM 500

120 led/mt 19,2 w/mt - IP 20
CRI80 - SDCM3
Lm/mt 800
24 Vdc - input current 0,8 A/mt

30.000h -20° +40° cm 5 6 LED

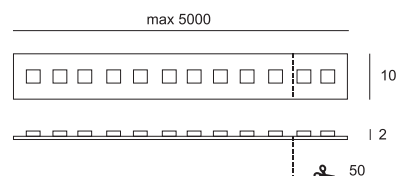

Code

97900

Led

Dynamic White
2700-7000°K



STRIP CM 10

120 led/mt 19,2 w/mt - IP 20
CRI80 - SDCM3
Lm/mt 800
24 Vdc - input current 0,8 A/mt

30.000h -20° +40° cm 5 6 LED

Code - cm 10

97990

Led

Dynamic White
2700-7000°K

Led CRI 80 IP 20

STRIP FLEX RGB + White 60 LED/MT - CRI 80 - IP 20

Strip led flessibile con biadesivo 3M cavo alimentazione rosso/nero cm 30.
Flexible strip led, red/black cable cm 30.



ROLLA CM 500

60 led/mt 19,2 w/mt - IP 20
CRI80 - SDCM3
Bianco = 2800/3300° K
24 Vdc - input current 0,8 A/mt

30.000h -20° +40° cm 5 6 LED

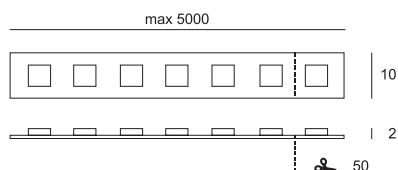

Code

97803

Led

RGB + White



STRIP CM 10

60 led/mt 19,2 w/mt - IP 20
CRI80 - SDCM3
Bianco = 2800/3300° K
24 Vdc - input current 0,8 A/mt

30.000h -20° +40° cm 5 6 LED

Code - cm 10

97893

Led

RGB + White

Led CRI 80 IP 20

Installare su superfici dissipanti il calore.

Applicazione in luoghi asciutti in ambienti interni.

Install only on dissipating surfaces. Application on a dry place indoors.

Il codice è riferito a cm10 - Per definire la lunghezza della strip considerare la misura di taglio del Led

Code is referred to 10cm - To define the final length of the strip consider the cut measure of the Led

STRIP FLEX 14,4 W/MT 140 LED/MT - CRI 90 - IP20

Strip led flessibile con biadesivo 3M 14,4 w/mt, cavo alimentazione rosso/nero cm 30.
Flexible strip led 14,4 w/mt, Red/Black cable cm 30.



ROLLA CM 500
140 led/mt 14,4 w/mt - IP 20
CRI90 - SDCM3 - SMD 2835
Lm/mt 1-1947 / 6-1836 / 8-1712 Lm
24 Vdc - input current 0,6 A/mt

30.000h -20° +40° cm 5,1 7 LED

Code

999040

Led

1 4000°K
6 3000°K
8 2700°K



STRIP CM 10
140 led/mt 14,4 w/mt - IP 20
CRI90 - SDCM3 - SMD 2835
Lm/mt 1-1947 / 6-1836 / 8-1712 Lm
24 Vdc - input current 0,6 A/mt

30.000h -20° +40° cm 5,1 7 LED

Code - cm 10

999049

Led

1 4000°K
6 3000°K
8 2700°K

Led CRI 90 IP 20

STRIP FLEX 14,4 W/MT 140 LED/MT - CRI 90 - IP 64

Strip led flessibile con biadesivo 3M 14,4 w/mt, cavo alimentazione rosso/nero cm 30.
Flexible strip led 14,4 w/mt, Red/Black cable cm 30.

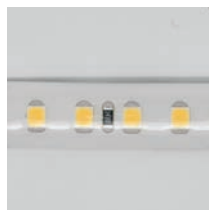

ROLLA CM 500
140 led/mt 14,4 w/mt - IP 64
CRI90 - SDCM3 - SMD 2835
Lm/mt 1-1947 / 6-1836 / 8-1712 Lm
24 Vdc - input current 0,6 A/mt

30.000h -20° +40° cm 5,1 6 LED

Code

999030

Led

1 4000°K
6 3000°K
8 2700°K

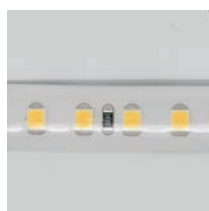

STRIP CM 10
140 led/mt 14,4 w/mt - IP 64
CRI90 - SDCM3 - SMD 2835
Lm/mt 1-1947 / 6-1836 / 8-1712 Lm
24 Vdc - input current 0,6 A/mt

30.000h -20° +40° cm 5,1 6 LED

Code - cm 10

999039

Led

1 4000°K
6 3000°K
8 2700°K

Led CRI 90 IP 64

Installare su superfici dissipanti il calore.

Applicazione: IP20 luoghi asciutti - IP64 luoghi asciutti e umidi

Install only on dissipating surfaces. Application: IP20 dry places - IP64 dry and humid places

Il codice è riferito a cm10 - Per definire la lunghezza della strip considerare la misura di taglio del Led

Code is referred to 10cm - To define the final length of the strip consider the cut measure of the Led

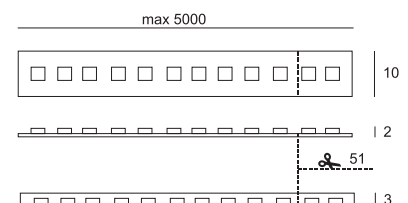

STRIP FLEX 14,4 W/MT 120 LED/MT - CRI 90 - IP 20

Strip led flessibile con biadesivo 3M 14,4 w/mt, cavo alimentazione rosso/nero cm 30 - lunghezza 10 mt.

Flexible strip led 14,4 w/mt, Red/Black cable cm 30 - lenght 10 mt.

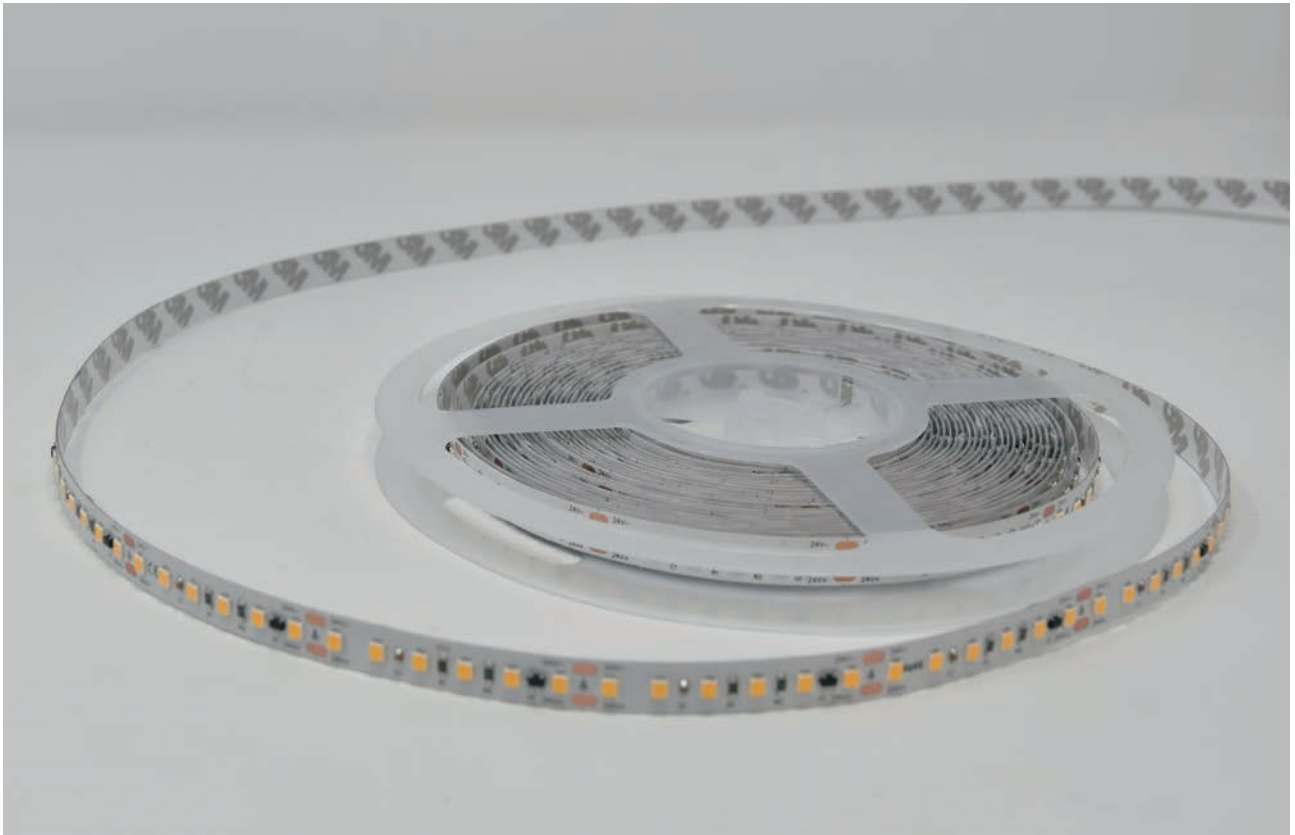

ROLLA CM 1000

120 led/mt 14,4 w/mt - IP 20
CRI90 - SDCM3 - SMD 2835
Lm/mt 1-1668 / 6-1573 / 8-1626
24 Vdc - input current 0,6 A/mt

30.000h $-20^{\circ}+40^{\circ}$ cm 5 6 LED

Code

999050

Led

1 4000°K
6 3000°K
8 2700°K

Installare su superfici dissipanti il calore. Applicazione in luoghi asciutti in ambienti interni.

Install only on dissipating surfaces. Application on a dry place indoors.

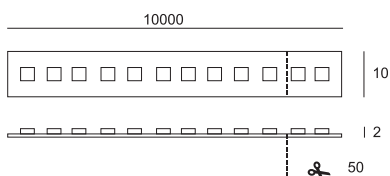

Led CRI 90 **A+** CE IP 20

STRIP FLEX 14,4 W/MT 60 LED/MT - CRI 80 - IP 20

Strip led flessibile con biadesivo 3M 14,4 w/mt, cavo alimentazione rosso/nero cm 30.
Flexible strip led 14,4 w/mt, Red/Black cable cm 30.



ROLLA CM 500
60 led/mt 14,4 w/mt - IP 20
CRI80 - SDCM3 - SMD 5050
Lm/mt 1-1487 / 6-1380
24 Vdc - input current 0,6 A/mt

Code

Led

9910

1 4000/4500°K
6 2800/3300°K
9 RGB

30.000h $-20^{\circ}+40^{\circ}$ cm 10 6 LED



STRIP CM 10
60 led/mt 14,4 w/mt - IP 20
CRI80 - SDCM3 - SMD 5050
Lm/mt 1-1487 / 6-1380
24 Vdc - input current 0,6 A/mt

Code - cm 10

Led

9919

1 4000/4500°K
6 2800/3300°K
9 RGB

30.000h $-20^{\circ}+40^{\circ}$ cm 10 6 LED

Led CRI 80 **A+** CE IP 20

STRIP FLEX 14,4 W/MT 60 LED/MT - CRI 80 - IP 64

Strip led flessibile con biadesivo 3M 14,4 w/mt, cavo alimentazione rosso/nero cm 30.
Flexible strip led 14,4 w/mt, Red/Black cable cm 30.

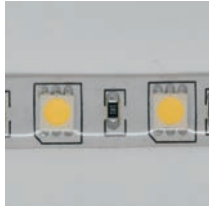

ROLLA CM 500
60 led/mt 14,4 w/mt - IP 64
CRI80 - SDCM3 - SMD 5050
Lm/mt 1-1487 / 6-1380
24 Vdc - input current 0,6 A/mt

Code

Led

990

1 4000/4500°K
6 2800/3300°K
9 RGB

30.000h $-20^{\circ}+40^{\circ}$ cm 10 6 LED

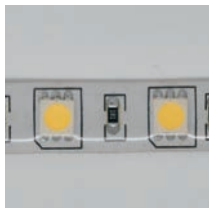

STRIP CM 10
60 led/mt 14,4 w/mt - IP 64
CRI80 - SDCM3 - SMD 5050
Lm/mt 1-1487 / 6-1380
24 Vdc - input current 0,6 A/mt

Code - cm 10

Led

999

1 4000/4500°K
6 2800/3300°K
9 RGB

30.000h $-20^{\circ}+40^{\circ}$ cm 10 6 LED

Installare su superfici dissipanti il calore. Applicazione: IP20 luoghi asciutti - IP64 luoghi asciutti e umidi
Install only on dissipating surfaces. Application: IP20 dry places - IP64 dry and humid places

Led CRI 80 **A+** CE IP 64

Il codice è riferito a cm10 - Per definire la lunghezza della strip considerare la misura di taglio del Led
Code is referred to 10cm - To define the final length of the strip consider the cut measure of the Led

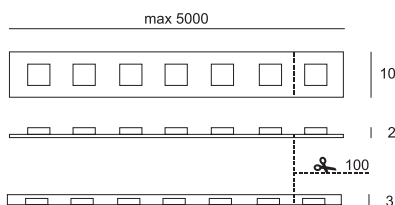

STRIP FLEX 9,6 W/MT 120 LED/MT - CRI 80 - IP 20

Strip led flessibile con biadesivo 3M 9,6 w/mt, cavo alimentazione rosso/nero cm 30.

Flexible strip led 9,6 w/mt, Red/Black cable cm 30.

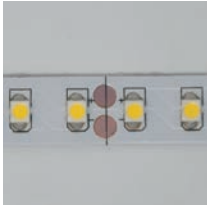

ROLLA CM 500

120 led/mt 9,6 w/mt - IP 20
CRI80 - SDCM3 - SMD 3528
Lm/mt 1-887 / 6-837
24 Vdc - input current 0,4 A/mt

30.000h -20°+40° cm 5 6 LED

Code

9740

Led

1 4000-4500°K
6 2800-3000°K



STRIP CM 10

120 led/mt 9,6 w/mt - IP 20
CRI80 - SDCM3 - SMD 3528
Lm/mt 1-887 / 6-837
24 Vdc - input current 0,4 A/mt

30.000h -20°+40° cm 5 6 LED

Code - cm 10

9749

Led

1 4000-4500°K
6 2800-3000°K

Led CRI 80 CE IP 20

STRIP FLEX 9,6 W/MT 120 LED/MT - CRI 80 - IP 64

Strip led flessibile con biadesivo 3M 9,6 w/mt, cavo alimentazione rosso/nero cm 30.

Flexible strip led 9,6 w/mt, Red/Black cable cm 30.



ROLLA CM 500

120 led/mt 9,6 w/mt - IP 64
CRI80 - SDCM3 - SMD 3528
Lm/mt 1-887 / 6-837
24 Vdc - input current 0,4 A/mt

30.000h -20°+40° cm 5 6 LED

Code

9730

Led

1 4000-4500°K
6 2800-3000°K



STRIP CM 10

120 led/mt 9,6 w/mt - IP 64
CRI80 - SDCM3 - SMD 3528
Lm/mt 1-887 / 6-837
24 Vdc - input current 0,4 A/mt

30.000h -20°+40° cm 5 6 LED

Cod - cm 10

9739

Led

1 4000-4500°K
6 2800-3000°K

Installare su superfici dissipanti il calore. Applicazione: IP20 luoghi asciutti - IP64 luoghi asciutti e umidi
Install only on dissipating surfaces. Application: IP20 dry places - IP64 dry and humid places

Led CRI 80 CE IP 64

Il codice è riferito a cm10 - Per definire la lunghezza della strip considerare la misura di taglio del Led
Code is referred to 10cm - To define the final length of the strip consider the cut measure of the Led

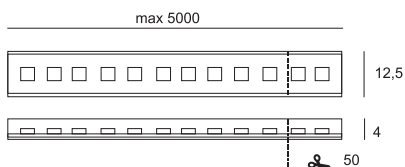

STRIP FLEX 4,8 W/MT 60 LED/MT - CRI 80 - IP 20

Strip led flessibile con biadesivo 3M 4,8 w/mt, cavo alimentazione rosso/nero cm 30.

Flexible strip led 4,8 w/mt, Red/Black cable cm 30.

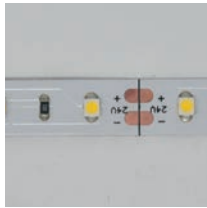

ROLLA CM 500
 60 led/mt 4,8 w/mt - IP 20
 CRI80 - SDCM3
 Lm/mt 1-438 / 6-418
 24 Vdc - input current 0,2 A/mt

30.000h -20°+40° cm 10 6 LED

Code	Led
9710	1 4000-4500°K 6 2800-3000°K

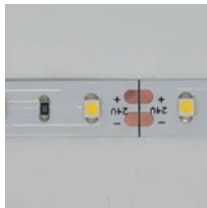

STRIP CM 10
 60 led/mt 4,8 w/mt - IP 20
 CRI80 - SDCM3
 Lm/mt 1-438 / 6-418
 24 Vdc - input current 0,2 A/MT

30.000h -20°+40° cm 10 6 LED

Code - 10 cm	Led
9719	1 4000-4500°K 6 2800-3000°K

Led CRI 80 CE IP 20

STRIP FLEX 4,8 W/MT 60 LED/MT - CRI 80 - IP 64

Strip led flessibile con biadesivo 3M 4,8 w/mt, cavo alimentazione rosso/nero cm 30.

Flexible strip led 4,8 w/mt, Red/Black cable cm 30.

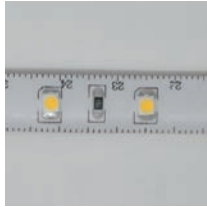

ROLLA CM 500
 60 led/mt 4,8 w/mt - IP 64
 CRI80 - SDCM3
 Lm/mt 1- 438 / 6-418
 24 Vdc - input current 0,2 A/mt

30.000h -20°+40° cm 10 6 LED

Code	Led
970	1 4000-4500°K 6 2800-3000°K 2 Blue 4 Green 7 Yellow 8 Red

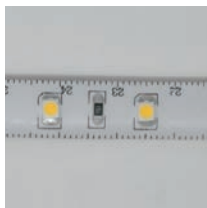

STRIP CM 10
 60 led/mt 4,8 w/mt - IP 64
 CRI80 - SDCM3
 Lm/mt 1-438 / 6-418
 24 Vdc - input current 0,2 A/mt

30.000h -20°+40° cm 10 6 LED

Code - 10 cm	Led
979	1 4000-4500°K 6 2800-3000°K 2 Blue 4 Green 7 Yellow 8 Red

Installare su superfici dissipanti il calore. Applicazione: IP20 luoghi asciutti - IP64 luoghi asciutti e umidi
 Install only on dissipating surfaces. Application: IP20 dry places - IP64 dry and humid places

Led CRI 80 CE IP 64

Il codice è riferito a cm10 - Per definire la lunghezza della strip considerare la misura di taglio del Led
 Code is referred to 10cm - To define the final length of the strip consider the cut measure of the Led

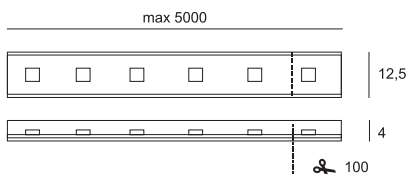

STRIP INGUAINATA 14,4 W/MT 140 LED/MT - CRI 80 - IP 67

Strip led flessibile inguainata IP67, cavo alimentazione FROR cm 100. Adatta per ambienti interni ed esterni.

Sia la misura della strip inguainata che del cavo di alimentazione può essere fornita a richiesta con misure personalizzate fino ad un massimo di mt5

Sheathed flexible strip led IP67. For cable cm 100. Suitable for indoor and outdoor environments.

Both the size of the sheathed strip and of the power cable can be supplied on request with customized measurements up to a maximum of 5 meters.

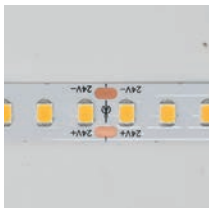

STRIP CM 10

140 led/mt 14,4 w/mt - IP67

CRI90 - SDCM3 - SMD 2835

Lm/mt 1947/1836/1712

24 Vdc - input current 0,6 A/mt

30.000h -20° +40° cm 5,1 6 LED

Code - cm 10

996724

Led

1		4000-4500°K
6		2800-3300°K
8		2800-3300°K

Installare su superfici dissipanti il calore
Install on heat dissipating surfaces

Il codice è riferito a cm10 - Per definire la lunghezza della strip considerare la misura di taglio del Led

Code is referred to 10cm - To define the final length of the strip consider the cut measure of the Led

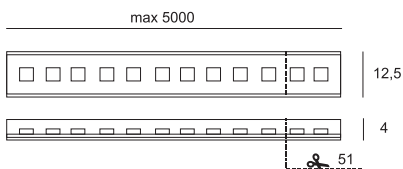

Led CRI 90 CE IP 67

STRIP INGUAINATA 9,6 W/MT 120 LED/MT - CRI 80 - IP 67

Strip led flessibile inguainata, IP67 9,6 w/mt, cavo alimentazione FROR cm 100

Sheated flexible strip led, IP67 9,6 w/mt, FROR cable cm 100.



STRIP CM 10

120 led/mt 9,6 w/mt - IP67
CRI80 - SDCM3 - SMD 3528
Lm/mt 1-887 / 6-837
24 Vdc - input current 0,4 A/mt

30.000h -20°+40° cm 5 6 LED

Code

996710

Led

1 4000-4500°K
6 2800-3300°K

Installare su superfici dissipanti il calore
Install on heat dissipating surfaces

Led CRI 80 IP 67

STRIP INGUAINATA 4,8 W/MT 120 LED/MT - CRI 80 - IP 67

Strip led flessibile inguainata, IP67 4,8 w/mt, cavo alimentazione FROR cm 100

Sheated flexible strip led, IP67 4,8 w/mt, FROR cable cm 100.



STRIP CM 10

60 led/mt 4,8 w/mt - IP67
CRI80 - SMD3528
Lm/mt 1-438 / 6-418
24 Vdc - input current 0,2 A/mt

30.000h -20°+40° cm 10 6 LED

Code

976705

Led

1 4000-4500°K
6 2800-3300°K

Il codice è riferito a cm10 - Per definire la lunghezza della strip considerare la misura di taglio del Led

Code is referred to 10cm - To define the final length of the strip consider the cut measure of the Led

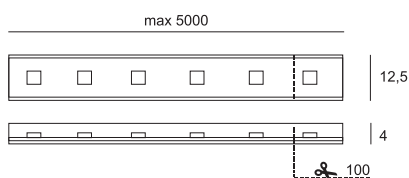

Led CRI 80 IP 67

SISTEMI

FOCUS 300

FOCUS 160

TWIN

sistemi

FOCUS 300

Design Athena

Focus 300 è un sistema a cavi 230V ideale per l'illuminazione di grandi spazi, uffici, show-room, negozi, ma utilizzabile anche in ambienti domestici come sale, cucine, corridoi. La vasta gamma degli accessori consente uno svariato utilizzo nella installazione del sistema, consentendo la tensione dello stesso in qualsiasi forma e di poter prendere l'alimentazione in qualsiasi punto del sistema.

L'apposito cavo a 2 conduttori consente inoltre sia l'accensione alternata che l'accensione simultanea dei corpi illuminanti, consentendo di alimentare gli stessi fino a 2500W per conduttore.

Focus 300 is a 230V cable system perfect for lighting large spaces, offices, show rooms and shops, but it can also be used in domestic environments such as lounges, kitchens and corridors. The vast range of accessories means the system can be installed in a variety of ways, making it possible to tension it in any shape and connect the electricity supply at any point in the system. The two-conductor cable supplied also makes it possible to switch the luminaires on alternately or simultaneously, meaning they can be supplied with up to 2500W per conductor.



Sorgente Led
Led lighting source

INTERASSE 300 MM



SORGENTE LED **4x4,5W - 220/240V**

Code	Color	Led
0289	5 White	1 4000°K - 2000 lm
	9 Black	6 3000°K - 1840 lm

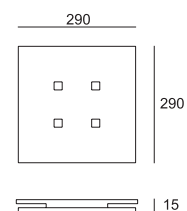







Sorgente Led
Led lighting source

INTERASSE 300 MM



SORGENTE LED 12W - 220/240V

Code	Color	Led
0290	5  White	1  4000°K - 1550 lm
	7  Grey	6  3000°K - 1450 lm
	9  Black	

295

70

135

Led CRI >90  CE IP 40    

610



Sorgente alogena o Led con pirex serigrafato/sabbiato
Lighting source with halogen lamp or Led and printed/mat glass-screen

INTERASSE 300 MM



SORGENTE HALO LED 220/240V

Code	Color	Lamp
O240	7  Grey	R7S mm 117 230W max R7S mm 117 Led max Ø 25

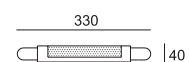

Sorgente con vetro extrachiario
Lighting source with extra Clear glass

INTERASSE 300 MM

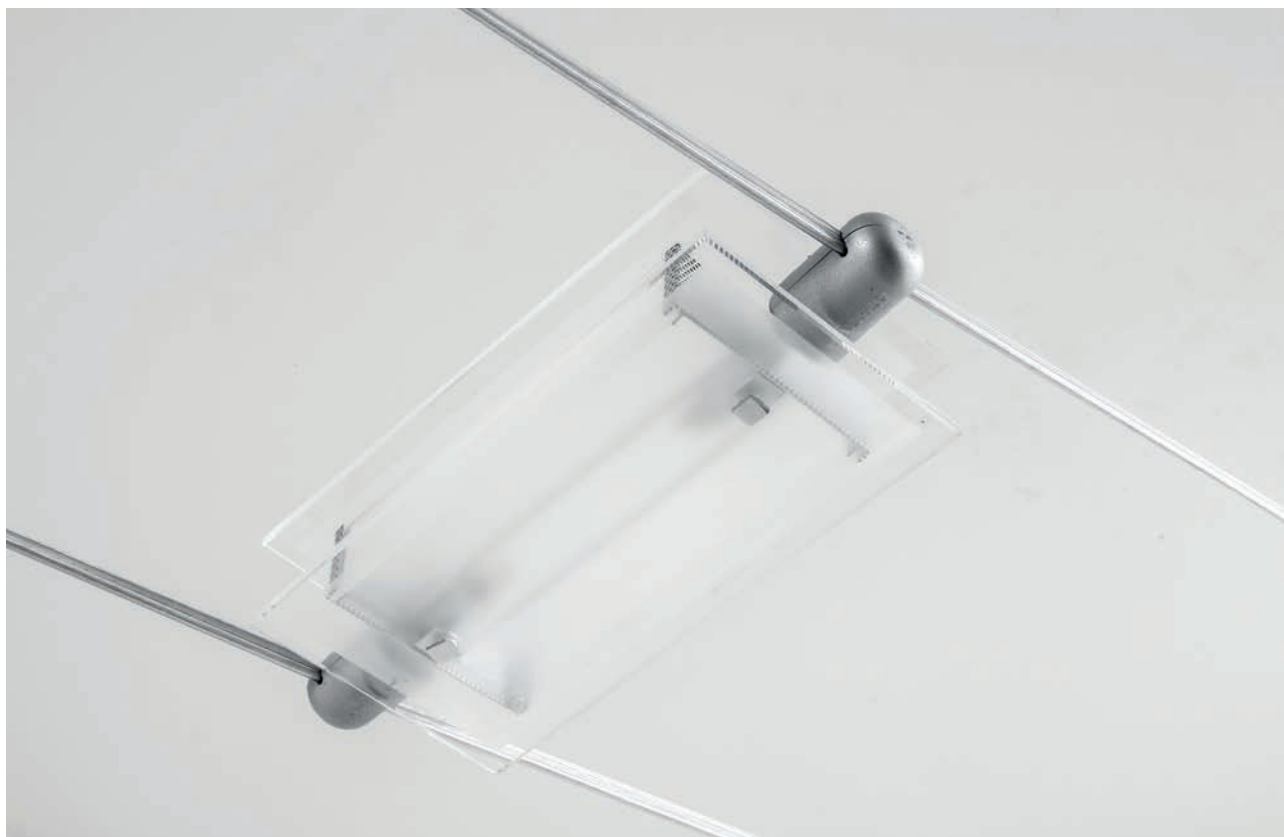

SORGENTE ORIENTABILE 220/240V

Code	Color	Lamp
O243	7  Grey	R7S mm 117 160W max R7S mm 117 Led max Ø 25

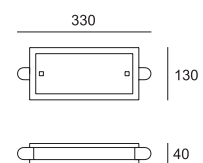

Faretto orientabile in metallo
Adjustable spotlight

INTERASSE 300 MM

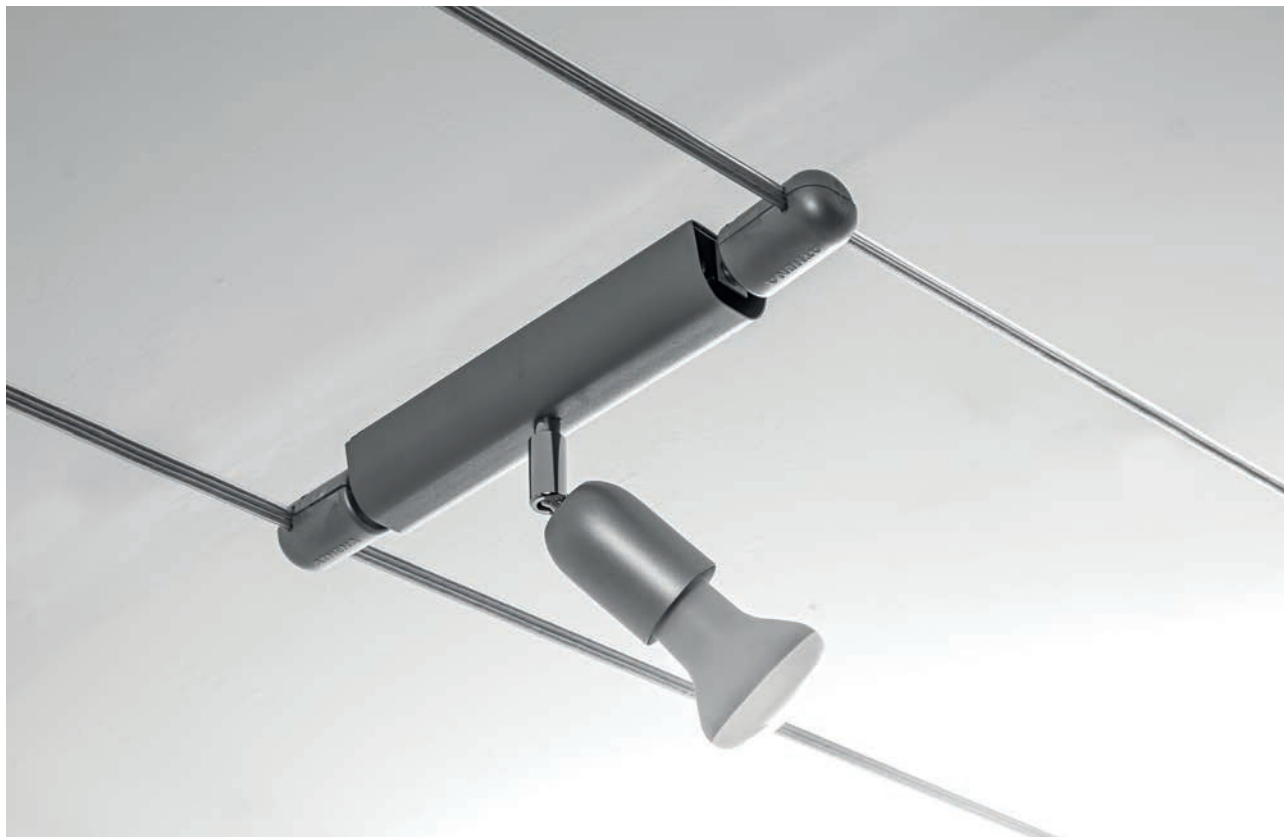

2 FARETTI ORIENTABILI 220/240V

Code	Color	Lamp
O282	7  Grey	E27 2x60W max E27 2 Led

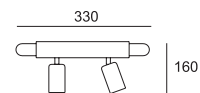

CE IP 20   
490

1 FARETTO ORIENTABILE 220/240V

Code	Color	Lamp
O272	7  Grey	E27 1x60W max E27 1 Led

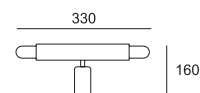

CE IP 20   
380

Sorgente orientabile alogena o Led
Adjustable Led or Halo lighting source

INTERASSE 300 MM



2 FARETTI ORIENTABILI 220/240V

Code	Color	Lamp
O251	1  Chrome	GU10 2 Led GU10 2 AR 111 Led

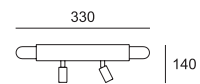

CE IP 20    
460

1 FARETTO ORIENTABILE 220/240V

Code	Color	Lamp
O234	1  Chrome	GU10 1 Led GU10 1 AR 111 Led

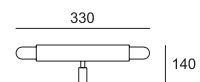

CE IP 20    
380

Sorgente orientabile Led
Adjustable Led lighting source

INTERASSE 300 MM



SORGENTE ORIENTABILE **220/240V**

Code	Color	Lamp
O211	7 Grey	GU10 AR 111 Led

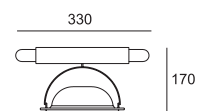

ACCESSORI FOCUS 300



CAVO

Cavo a due conduttori in rame e uno in acciaio per accensioni alternate. Idoneo per l'applicazione di apparecchi in classe II
2 copper connection cables and one steel cable to obtain alternated lighting fitted for lamps CL II

Code

0200

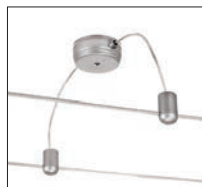

ALIMENTAZIONE

Alimentazione parete/soffitto applicabile in qualsiasi punto del sistema (senza cavi)
Ceiling fitted leaders that can be applied to any point of the system (without cables)

Code

0202



Color

7 Grey



SOSTEGNO

Coppia sostegno cavi per tesate molto lunghe o quando vi siano numerosi corpi lampade, H max 2000 mm.
Twin support cables for long sections or with many lamps, H max 2000 mm.

Code

0203



Color

1 Chrome

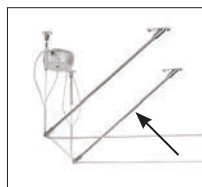

DISTANZIATORE

Distanziatore per tendere i cavi a soffitto in assenza di pareti, H max 300 mm.
Distance piece for tightening cables to ceiling without walls, H max 300 mm.

Code

0204



Color

1 Chrome

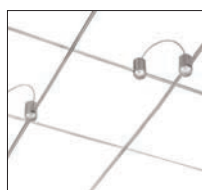

ALIMENTAZIONE

Coppia cavi alimentazione
Twin power supply cables

Code

0205



Color

7 Grey



DEVIATORI

Coppia deviatori a parete
Wall deviation twin set

Code

0206



Color

7 Grey



ANGOLARE

Supporto angolare parete 90°-120°
Angular wall support 90°-120°

Code

0207



Color

7 Grey

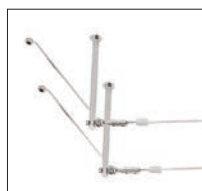

STAFFE

Coppia staffa sostegno + rinforzo per staffa altezza massima 250 mm
Couple ceiling support bracket + reinforcements bracket max high 250 mm

Code

0208



Color

1 Chrome



TENDICAVO

Kit tendicavo snodato composto da 4 tiranti e 4 isolanti - Interasse 300 mm
Jointed cable 4 tightening and 4 insulating - Distance 300 mm

Code

0209



Color

1 Chrome



TENDICAVO

Kit tendicavo snodato composto da 4 tiranti, 2 isolanti e scatola per alimentazione elettrica - Interasse 300 mm

Jointed cable composed by 4 tightening, 2 insulating and electrical connectors - Distance 300 mm

Code

Color

0210

7 ■ Grey



CURVA

Kit per curve da 45° a 120° composto da staffa e rinforzo, H max 250 mm.

Kit for a curve from 45° to 120° degrees, composed by bracket and reinforcement, H max 250 mm.

Code

Color

0214

1 ■ Chrome



FOCUS 160

Design Athena

Il sistema a cavi Focus 160 può essere utilizzato in qualsiasi tipo di ambiente, sia lavorativo che domestico.

La vasta gamma di accessori e la versatilità del prodotto permettono di creare infinite varianti di sistemi, creando punti di luci in qualsiasi punto dell'ambiente in cui vengono collocati. Il cavo a 2 conduttori consente sia l'accensione alternata che l'accensione simultanea di tutti i corpi illuminanti. L'alimentazione può essere fatta in qualsiasi punto del sistema.

The cable system Focus 160 can be used in any type of locations, be it the workplace or home. The high variety of accessories and the versatility of the product give the possibility to create infinite variations of systems, creating light points in any point of the location in which they are placed. The 2-conductors cables permit the alternate turn on or the simultaneous turn on in all the enlightened bodies. Power supplies can be made in any part of the system.



Sorgente Led orientabile
Adjustable Led lighting source

INTERASSE 160 MM



SORGENTE LED 12W - 220/240V

Code	Color	Led	Polycarbonate
0457	5 White	1 4000°K - 1200 lm 6 3000°K - 1000 lm	1 Trasparent 7 Orange 8 Red

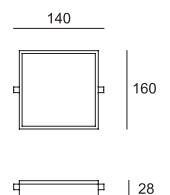

Led CRI >80 CE IP 40 320

Sorgente Led orientabile
Adjustable Led source

INTERASSE 160 MM

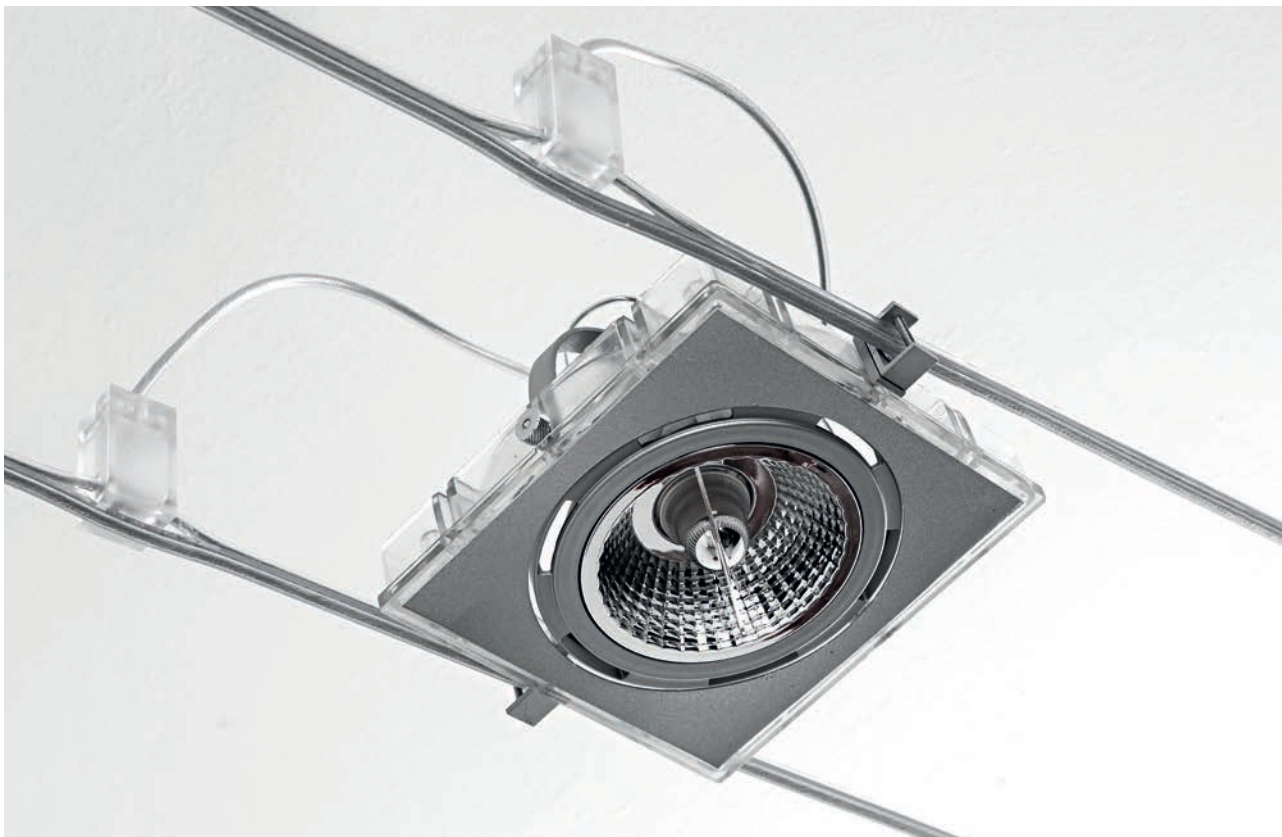
SORGENTE LED **220/240V**

Code

0458

Color

5  White

Lamp

GU10 AR 111 Led

Polycarbonate

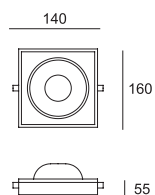
1  Trasparent7  Orange8  Red

Sorgente Led orientabile
Adjustable Led source

INTERASSE 160 MM



SORGENTE LED ORIENTABILE 12W - 220/240V

Code	Color	Led
0490	5 White	1 4000°K - 1550 lm
	7 Grey	6 3000°K - 1450 lm
	9 Black	

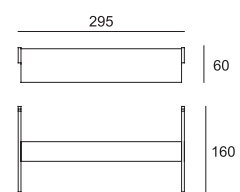

Led CRI >90 IP 40 670

Faretti orientabili in metallo
Adjustable spotlight

INTERASSE 160 MM



FARETTO ORIENTABILE 220/240V

Code	Color	Lamp
0472	7 Grey	E27 60W max E27 Led

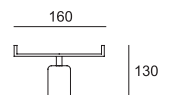

Sorgente Led orientabile
Adjustable Led source

INTERASSE 160 MM

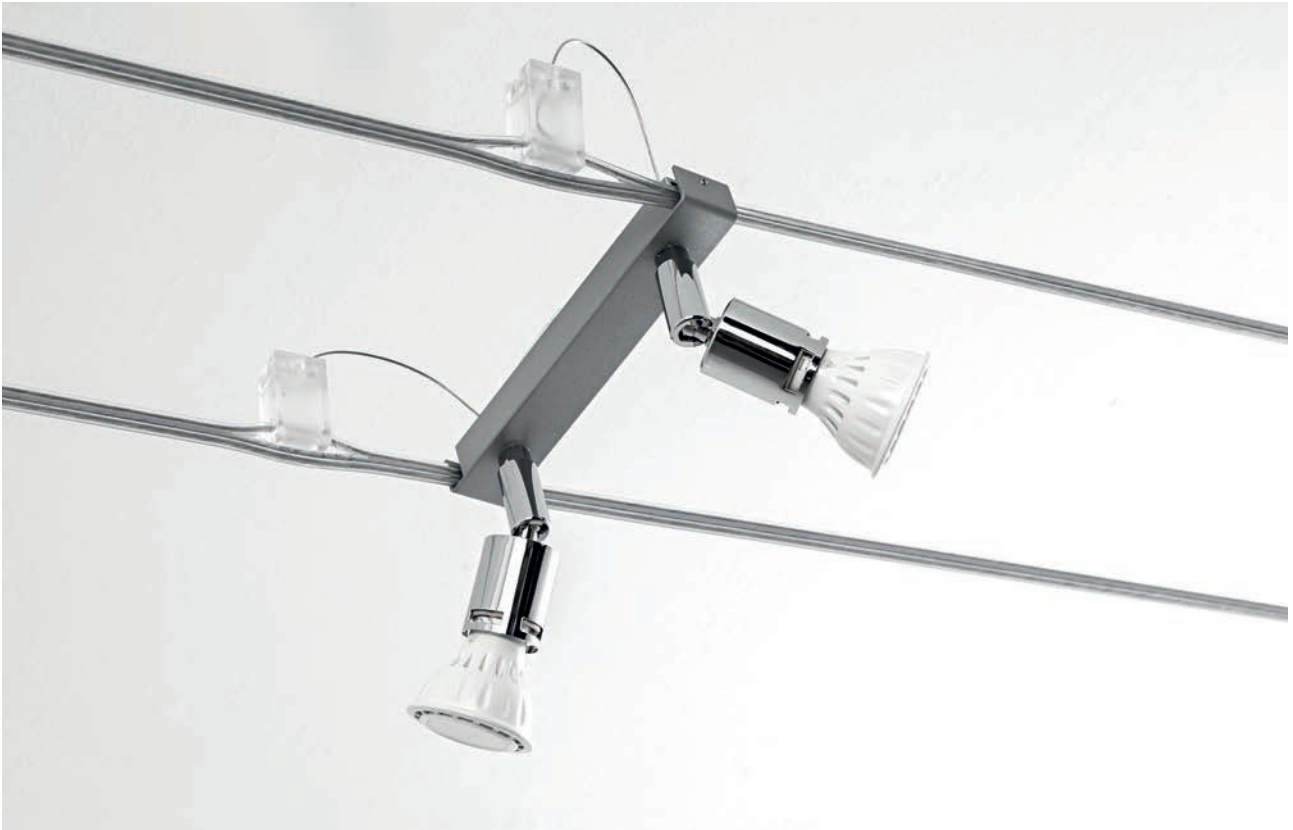

1 FARETTO ORIENTABILE 220/240V

Code	Color	Lamp
O434	1  Chrome	GU10 1 Led GU10 1 AR 111 Led

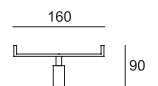

CE IP 20   
170

2 FARETTI ORIENTABILI 220/240V

Code	Color	Lamp
O435	1  Chrome	GU10 2 Led GU10 2 AR 111 Led

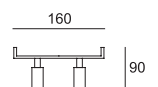

CE IP 20   
280

ACCESSORI FOCUS 160



CAVO

Cavo a due conduttori in rame e uno in acciaio per accensioni alternate. Idoneo per l'applicazione di apparecchi in classe II

2 copper connection cables and one steel cable to obtain alternated lighting fitted for lamps CL II

Code

0200

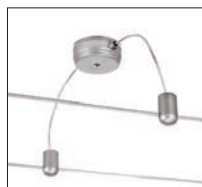

ALIMENTAZIONE

Alimentazione parete/soffitto applicabile in qualsiasi punto del sistema (senza cavi)

Ceiling fitted leaders that can be applied to any point of the system (without cables)

Code

0202



Color

7 Grey



SOSTEGNO

Coppia sostegno cavi per tesate molto lunghe o quando vi siano numerosi corpi lampade, H max 2000 mm.

Twin support cables for long sections or with many lamps, H max 2000 mm.

Code

0203



Color

1 Chrome

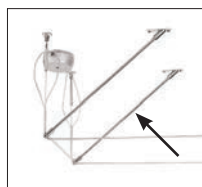

DISTANZIATORE

Distanziatore per tendere i cavi a soffitto in assenza di pareti, H max 300 mm.

Distance piece for tightening cables to ceiling without walls, H max 300 mm.

Code

0204



Color

1 Chrome

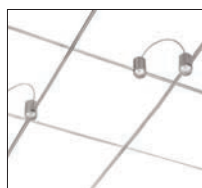

ALIMENTAZIONE

Coppia cavi alimentazione

Twin power supply cables

Code

0205



Color

7 Grey

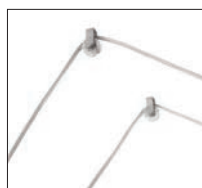

DEVIATORI

Coppia deviatori a parete

Wall deviation twin set

Code

0206



Color

7 Grey



ANGOLARE

Supporto angolare parete 90°-120°

Angular wall support 90°-120°

Code

0207



Color

7 Grey



STAFFE

Coppia staffa sostegno + rinforzo per staffa altezza massima 250 mm

Couple ceiling support bracket + reinforcements bracket max height 250 mm

Code

0208



Color

1 Chrome



TENDICAVO

Kit tendicavo snodato composto da 4 tiranti e 4 isolanti - Interasse 160 mm

Jointed cable 4 tightening and 4 insulating - Distance 160 mm

Code

0209



Color

1 Chrome



TENDICAVO

Kit tendicavo snodato composto da 4 tiranti, 2 isolanti e scatola per alimentazione elettrica interasse 160 mm

Jointed cable composed by 4 tightening, 2 insulating and electrical connectors, distance 160 mm

Code

Color

0210

7 ■ Grey



CURVA

Kit per curve da 45° a 120° composto da staffa e rinforzo, H max 250 mm.

Kit for a curve from 45° to 120° degrees, composed by bracket and reinforcement, H max 250 mm.

Code

Color

0214

1 ■ Chrome



TWIN

Design Athena

INTERASSE 135 MM CON FARETTI CON ADATTATORE.
INTERASSE DISTANZA MAX 5000 MM CON SOSPENSIONI VETRO.

Twin è un sistema a 12 Vdc tensione costante. Sviluppato su un doppio cavo elettrificato. Risulta adatto per ogni soluzione illuminotecnica che voglia essere allo stesso tempo pratica, semplice nell'installazione, elegante e di grande effetto.

Data l'essenzialità delle sue linee risulta ottimale per ogni ambiente, che sia un'abitazione, uno show-room o un luogo più sobrio quale potrebbe essere un museo o una galleria d'arte. Con l'ampia gamma di sorgenti luminose e di componenti, la struttura ottiene il massimo della flessibilità.

Alla versatilità del sistema è affiancato inoltre un elevato standard qualitativo raggiunto basandone lo sviluppo sulle caratteristiche principali della nostra produzione: estetica, sicurezza e praticità. Si consiglia di restare entro una linea continua di max 8 m. alimentata da alimentatori a tensione costante.

Twin is a 12 Vdc constant voltage. Based on an electrified double cable it is suitable for any technical lighting solution that needs to be practical, easy to install, elegant and of great effect. Thanks to its clean lines it is suitable for any environment, whether it may be a home, showroom or a more austere setting such as a museum or art gallery.

The structure offers great flexibility thanks to the wide range of light sources and components available.

Alongside its versatility, the system also boasts a high standard of quality obtained by basing its development on the main features of our production range: appearance, safety and practicality. We recommend staying within a maximum continuous line of 8 metres with power supplied with a constant tension DRIVERS.









Sorgente Led orientabile
Adjustable Led lighting source

INTERASSE 135 MM



FARETTO ORIENTABILE LED 5,8W - 12Vdc

Code	Color	Led	Polycarbonate
0357	1  Chrome	1  4000°K - 920 lm 6  3000°K - 848 lm	1  Trasparent 7  Orange 8  Red

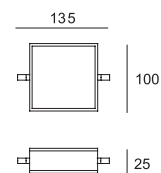

Led CRI >80  CE IP 40   212



Sorgente Led orientabile
Adjustable Led lighting source

INTERASSE 135 MM



FARETTO ORIENTABILE LED 5,8W - 12Vdc

Code	Color	Led
0358	5  White	1  4000°K - 920 lm 6  3000°K - 848 lm

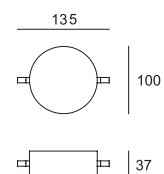



Led CRI >80  CE IP 40   
202

Sorgente Led
Led source

INTERASSE 135 MM



SORGENTE LED **5,8W - 12Vdc**

Code	Color	Led
0360	5  White	1  4000°K - 920 lm 6  3000°K - 848 lm

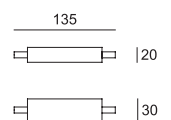

Sorgente Led
Led source

INTERASSE 135 MM

SORGENTE LED **10W - 12Vdc**

Code	Color	Led
0361	5 White	1 4000°K - 758 lm 6 3000°K - 739 lm

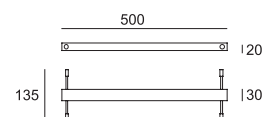

Led CRI >90 IP 40 515

SORGENTE LED **19W - 12Vdc**

Code	Color	Led
0362	5 White	1 4000°K - 1548 lm 6 3000°K - 1509 lm

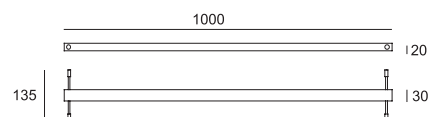

Led CRI >90 IP 40 840



Sospensione Led
Led suspension



SORGENTE LED **5,8W - 12Vdc**

Code	Color	Led
0363	5  White	1  4000°K - 920 lm 6  2800°K - 848 lm

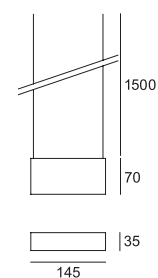

Sorgenti Led
Led lighting sources



FARETTO ORIENTABILE 12Vdc

Code	Color	Lamp
0353	1 Chrome	G5,3 Led

250



Sorgenti Led
Led lighting sources



FARETTO 12Vdc

Code	Color	Lamp
0355	1  Chrome	G4 Led G6,35 Led

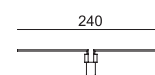



Sorgenti Led
Led lighting sources



FARETTO ORIENTABILE **12Vdc**

Code	Color	Lamp
0354	1  Chrome	G5,3 Led

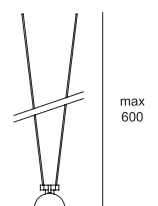

Sorgenti Led
Led lighting sources



FARETTO ORIENTABILE 12Vdc

Code	Color	Lamp
3110	1  Chrome	G5,3 Led

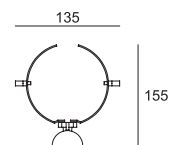

Sorgenti Led
Led lighting sources



FARETTO ORIENTABILE 12Vdc

Code	Color	Lamp
3310	1  Chrome	G5,3 Led

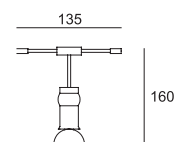



Sorgenti Led
Led lighting sources



FARETTI ORIENTABILI **12Vdc**

Code	Color	Lamp
1410	7  Grey	G53 AR111 Led

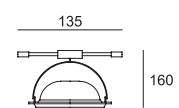



Sospensione con cavo mm 6000 - Interasse max mm 5000
 Suspensions with cable mm 6000 - Interaxis distance mm 5000



Code _____ **Color** _____ **Glass** _____

O647 _____ **1** Chrome _____ **1** Clear _____
3 Pink Gold _____ **3** Pink Gold _____
9 Black Chrome _____ **9** Black Chrome _____

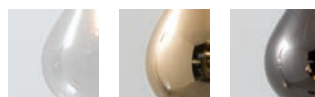

1 **3** **9**

G4 12 Vdc Led _____
G5,3 12 Vdc Led _____
G6,35 12 Vdc Led _____

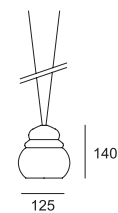

CE IP 20 240



Code _____ **Color** _____ **Glass** _____

O648 _____ **1** Chrome _____ **1** Clear _____
3 Pink Gold _____ **3** Pink Gold _____
9 Black Chrome _____ **9** Black Chrome _____

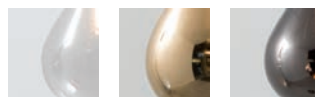

1 **3** **9**

G4 12 Vdc Led _____
G5,3 12 Vdc Led _____
G6,35 12 Vdc Led _____

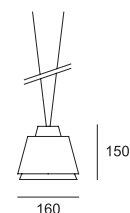

CE IP 20 370



Code _____ **Color** _____ **Glass** _____

O631 _____ **1** Chrome _____ **1** Clear _____

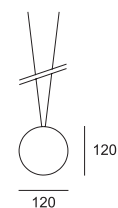

G4 12 Vdc Led _____
G6,35 12 Vdc Led _____

CE IP 20 240

Sospensione con cavo mm 6000 - Interasse max mm 5000
 Suspensions with cable mm 6000 - Interaxis distance mm 5000

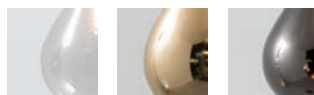
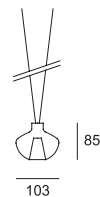
**Code****0635****Color****1** Chrome**Glass****1** Clear**3** Pink Gold**9** Black Chrome 1 3 9**G4** 12 Vdc Led**G6,35** 12 Vdc Led

CE IP 20 165

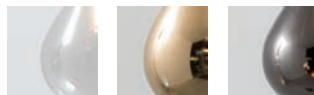
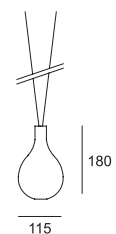
**Code****0644****Color****1** Chrome**Glass****1** Clear**3** Pink Gold**9** Black Chrome 1 3 9**G4** 12 Vdc Led**G6,35** 12 Vdc Led

CE IP 20 205

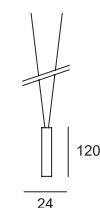
**Code****0646****Color****1** Chrome**Glass****1** Satined**G4** 12 Vdc Led**G6,35** 12 Vdc Led

CE IP 20 120

Sospensione con cavo mm 6000 - Interasse max mm 5000
 Suspensions with cable mm 6000 - Interaxis distance mm 5000



Code _____ **Color** _____ **Glass** _____

0649 _____ **1** Chrome _____ **1** Clear _____
3 Pink Gold _____ **9** Black Chrome _____



1 _____ **3** _____ **9** _____

G4 _____ 12 Vdc Led _____
G6,35 _____ 12 Vdc Led _____

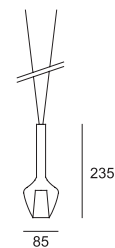

CE IP 20 250



Code _____ **Color** _____ **Glass** _____

0639 _____ **1** Chrome _____ **1** Satined _____

G4 _____ 12 Vdc Led _____
G5,3 _____ 12 Vdc Led _____
G6,35 _____ 12 Vdc Led _____

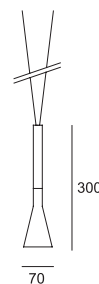

CE IP 20 235



Code _____ **Color** _____ **Glass** _____

0640 _____ **1** Chrome _____ **1** Satined _____

G4 _____ 12 Vdc Led _____
G5,3 _____ 12 Vdc Led _____
G6,35 _____ 12 Vdc Led _____

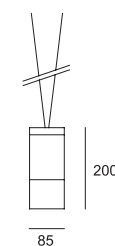

CE IP 20 370

ACCESSORI TWIN

**COPPIA SOSTEGNO CAVI**

Coppia sostegno cavi per tesate molto lunghe
o quando vi siano numerosi corpi lampade H 2000 mm
Twin support cables for long sections or with many lamps H 2000 mm

Code**0203****Color**1  Chrome**STAFFE**

Coppia staffa sostegno
+ coppia rinforzo per staffa H max 250 mm
Pair of support bracket
+ pair of reinforcement brackets H max 250 mm

Code**0208****Color**1  Chrome**ALIMENTAZIONE**

Coppia alimentazione (cavi non forniti)
Couple of power accessories (without cable)

Code**0328****Color**1  Chrome**CAVO RAME NON ISOLATO**

Cavo rame non isolato mmq. 6 - 30A
Copper cable not insulated mmq. 6 - 30A

Code**0319****CAVO RAME ISOLATO**

Cavo rame isolato mmq. 6 - 25A
Copper cable insulated mmq. 6 - 25A

Code**0329****TENDICAVO**

Kit tendicavo snodato - 4 tiranti
Jointed cable tightening kit

Code**0330****Color**1  Chrome**STAFFE**

Coppia staffa sostegno H 250 mm
Pair of ceiling support brackets H 250 mm

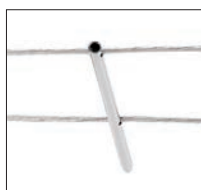
Code**0331****Color**1  Chrome**STAFFA**

Staffa sostegno a parete H 250 mm
Wall support bracket H 250 mm

Code**0335****Color**1  Chrome**KIT PER CURVE**

Kit per curve da 45° a 120° + staffa+rinforzo H max 250 mm
Kit for a curve from 45° to 120° degrees + brackets + reinforcements H max 250 mm

Code**0336****Color**1  Chrome

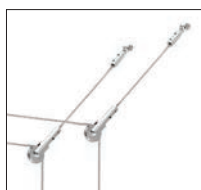
**KIT PER CURVA**

Kit per curva regolabile parete/soffitto
Couple of wall/ceiling adjustable curve

Code**Color****0338****1**  Chrome**GIUNTI**

Coppia giunti isolante
Couple of insulating joint

Code**Color****0339****1**  Chrome**STAFFE**

Coppia staffa sostegno H 95 mm
Pair of ceiling support brackets H 95 mm

Code**Color****0340****1**  Chrome**STAFFE**

Coppia staffa sostegno H 95 mm
Pair of ceiling support brackets H 95 mm

Code**Color****0341****1**  Chrome

Contenitore in metallo con alimentatore 230/12Vdc completo di coppia di alimentazione per Led.

Box with driver 230/12Vdc with feed supply couple for Led.



Code	Color	Watt
1289	5 White	75W 12Vdc

Ø 170x40

CE IP 20 680

Code	Color	Watt
1290	5 White	150W 12Vdc

Ø 220x45

CE IP 20 1100



Code	Color	Watt
1291	5 White	75W 12Vdc

180x140x40

CE IP 20 670

Code	Color	Watt
1292	5 White	150W 12Vdc

230x130x40

CE IP 20 1010

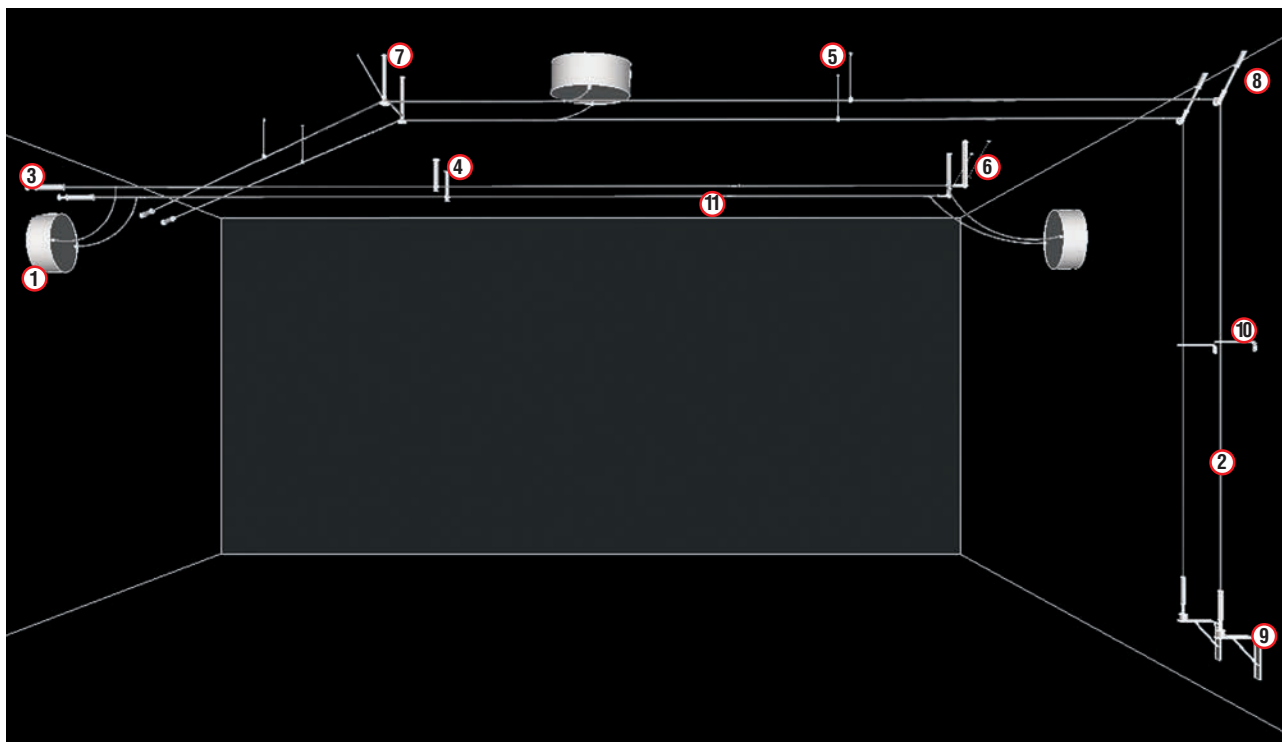

① **1289** **1290** **1291** **1292**

Contenitore con alimentatore.
Box with power supply.

⑤ **0203 1** cromo

Staffa sostegno cavi.
Twin support cables.

⑨ **0340**

Coppia staffa sostegno.
Pair of ceiling support brackets.

② **0329** **0319**

Cavo rame.
Copper cable.

⑥ **0208 1** cromo

Coppia staffa sostegno.
Couple support bracket.

⑩ **0341**

Coppia staffa sostegno.
Pair of ceiling support brackets.

③ **0330 1** cromo

Kit tendicavo.
Jointed cable tightening kit.

⑦ **0336 1** cromo

Kit per curva 45° a 120°.
Kit for a curve from 45° to 120°.

⑪ **0339**

Coppia giunti isolante.
Insulating joint couples.

④ **0331 1** cromo

Staffa sostegno soffitto.
Ceiling support brackets.

⑧ **0338 1** cromo

Curva regolabile.
Adjustable curve.

DECORATIVO

BRIDGE
SWING
LIBRO
MODÌ
OMICRON
INCROCIO
EDERA
DADAJE
GIOTTO
DEGAS
MONET
PICASSO
RIFLESSI
KITE
MILO
BETA
ARTE
FARETTI

Decorativo

BRIDGE





Design Athena

Collezione di plafoniere disponibili nelle finiture bianca, corten e nero. Le diverse misure e altezze ne permettono la combinazione tra di loro in varie soluzioni. Il rosone e la misura del cavo di alimentazione dovrà essere scelto in funzione degli accostamenti che si vogliono ottenere. A richiesta le plafoniere possono essere dimmerate tramite l'accessorio 1298.

Ceiling lights available in white, corten, and black finishings. Different measures and heights make it possible the various combinations among them. The canopy and the measure of the power cable will have to be chosen with respect to the combinations that are wished to be obtained. Upon request, the light could be adjusted thanks to the 1298 accessory.







PLAFONIERA LED H150 - 10,5W 220/240V

Code	Color	Led
802120	4  Corten	1  4000°K 1557 lm
	5  White	6  3000°K 1468 lm
	9  Black	





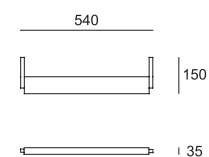

PLAFONIERA LED H150 - 19,2W 220/240V

Code	Color	Led
802220	4  Corten	1  4000°K 2872 lm
	5  White	6  3000°K 2726 lm
	9  Black	







Led CRI >90  CE IP 40  

PLAFONIERA LED H250 - 10,5W 220/240V

Code	Color	Led
802320	4  Corten	1  4000°K 1557 lm
	5  White	6  3000°K 1468 lm
	9  Black	



PLAFONIERA LED H250 - 19,2W 220/240V

Code	Color	Led
802420	4  Corten	1  4000°K 2872 lm
	5  White	6  3000°K 2726 lm
	9  Black	

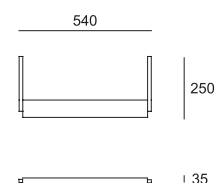

Led CRI >90  CE IP 40  



KIT ALIMENTAZIONE

Cavo elettrico trasparente cm. 200

Cavo colorato in tessuto a richiesta: 5 bianco - 8 rosso - 9 nero

Electric transparent cable cm. 200

Colored cables on request: 5 white - 8 red - 9 black

Code

9857





Color

4  Corten

5  White





9  Black

PLAFONIERA LED H150 - 19,5W 220/240V

Code	Color	Led
802520	4  Corten	1  4000°K 3000 lm
	5  White	6  3000°K 2832 lm
	9  Black	





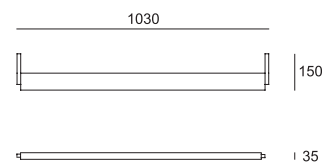

PLAFONIERA LED H150 - 38W 220/240V

Code	Color	Led
802620	4  Corten	1  4000°K 5780 lm
	5  White	6  3000°K 5452 lm
	9  Black	







Led CRI >90  CE IP 40  

PLAFONIERA LED H250 - 19,5W 220/240V

Code	Color	Led
802720	4  Corten	1  4000°K 3000 lm
	5  White	6  3000°K 2832 lm
	9  Black	



PLAFONIERA LED H250 - 38W 220/240V

Code	Color	Led
802820	4  Corten	1  4000°K 5780 lm
	5  White	6  3000°K 5452 lm
	9  Black	

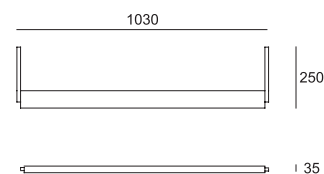

Led CRI >90  CE IP 40  

SWING

Design Athena





Collezione di plafoniere disponibili nelle finiture bianco, corten e nero. I bracci delle lampade sono orientabili a 360°. A richiesta le plafoniere possono essere dimmerate tramite l'accessorio 1298.

Ceiling lights available in white, corten, and black finishings. The arms of the lamps are adjustable at 360°. Upon request, the light could be adjusted thanks to the 1298 accessory.







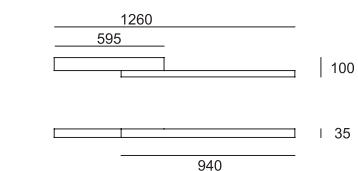

PLAFONIERA LED 30W 10,5W 220/240V

Code	Color	Led
812120	4  Corten	1  4000°K 4480 lm
	5  White	6  3000°K 4230 lm
	9  Black	

Led CRI >90  CE IP 40  

PLAFONIERA LED 48,5W 220/240V

Code	Color	Led
812320	4  Corten	1  4000°K 7448 lm
	5  White	6  3000°K 7000 lm
	9  Black	

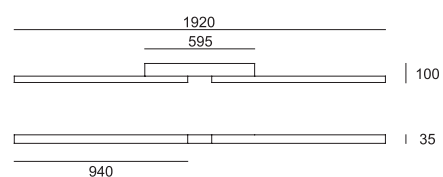
Led CRI >90  CE IP 40  

LIBRO

Design Athena





Appliche LED laccata bianco, corten, grigio e nero. Nonostante le dimensioni contenute l'appliche monta un led da 40W che sviluppa 3800lm e lo rende adatto all'illuminazione di vari ambienti.

Led applique white, corten, grey and black. Even though it has small dimensions, the device supports a 40W led which develops 3800lm and which will make it suitable for the illumination in many locations.



APPLIQUE LED

Sorgente Led 40W - 220/240v dimmerabile

Code	Color	Led
8662	4  Corten	6  3000°K 3800 lm
	5  White	
	7  Grey	
	9  Black	

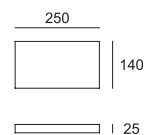

Led CRI >80  CE IP 40  





MODÌ

Design Athena

Applique e piantana LED laccati bianco, nero e grigio. Nonostante le dimensioni contenute gli apparecchi montano un led da 40W che sviluppa 3800lm e li rendono adatti all'illuminazione di vari ambienti.

Led applique and floor lamp painted white, black and grey. Even though it has small dimensions, the device supports a 40W led which develops 3800lm and which will make it suitable for the illumination in many locations.



APPLIQUE LED

Sorgente Led 40W - 220/240v dimmerabile

Code	Color	Led
8661	5 White 7 Grey 9 Black	6 3000°K 3800 lm

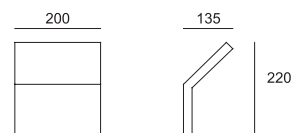

Led CRI >80 CE IP 40

PIANTANA LED 40W 220/240V DIMMERABILE

40W - 220/240v dimmerabile

Code	Color	Led
8680	5 White (cavo tessuto bianco) 7 Grey (cavo tessuto grigio) 9 Black (cavo tessuto nero)	6 3000°K 3800 lm



Cavo colorato rosso a richiesta
Red cable on demand

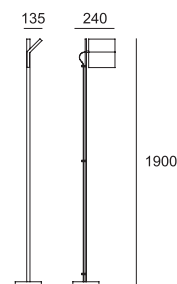

Led CRI >80 CE IP 40

OMICRON

Design Athena

Plafoniere, sospensioni e applique LED realizzate in alluminio verniciato completo di policarbonato PMMA. Disponibile nelle finiture bianco, gold, corten, grigio e nero. L'essenzialità della linea ne permette l'utilizzo in qualsiasi ambiente sia lavorativo che domestico.

Ceiling lights, pendant lamps, and LED appliques realised in painted aluminium completed with polycarbonate PMMA. Available in white, golden, corten, grey and black finishings. The essentiality of this line of products permits the use of them both at the work place and at home.



OMICRON PLAFONE 220/240V

**OMICRON PLAFONIERA
1 LINEA LED**

240 led/mt 19,2 w/mt
Lm/m 1540/1580
24 Vdc CRI90 **A** SDCM3

30.000h $-20^{\circ} + 40^{\circ}$ cm 2,5

Code - 10 cm

98210108

Color

3 Gold
4 Corten
5 White
7 Grey
9 Black

Led

1 4000°K
6 3000°K

**OMICRON PLAFONIERA
2 LINEE LED**

240 led/mt 19,2 w/mt
Lm/m 3080/3160
24 Vdc CRI90 **A** SDCM3

30.000h $-20^{\circ} + 40^{\circ}$ cm 2,5

Code - 10 cm

98210208

Color

3 Gold
4 Corten
5 White
7 Grey
9 Black

Led

1 4000°K
6 3000°K

SCHERMI

**1** Satinato**4** Curvo**5** Prismatico

ACCESSORI CODE 98210108 Dettagli pag 14

9895
Schermo
antiabbagliamento

**Il codice del prodotto è riferito a 10 cm di plafoniera.
In fase d'ordine precisare la misura della plafoniera richiesta.**

Code number refer to 10 cm of ceiling fixture.
Ordering specify the lenght of the ceiling fixture required.

A

_____ | 70

_____ | 35

A: Color: **4-5-7-9** max cm 300 - **3** max cm 200

Led CRI >90 **A** CE IP 40

ACCESSORI **1298** Dimmer push

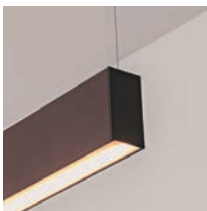

OMICRON LED SOSPENSIONE 220/240

OMICRON SOSPENSIONE
1 LINEA LED

240 led/mt 19,2 w/mt
Lm/m 1540/1580
24 Vdc CRI90 **A** SDCM3

30.000h $-20^{\circ}+40^{\circ}$ cm 2,5

Code - 10 cm

98510108



Color

- 3 Gold
- 4 Corten
- 5 White
- 7 Grey
- 9 Black

Led

- 1 4000°K
- 6 3000°K

OMICRON SOSPENSIONE
2 LINEE LED

240 led/mt 19,2 w/mt
Lm/m 3080/3160
24 Vdc CRI90 **A** SDCM3

30.000h $-20^{\circ}+40^{\circ}$ cm 2,5

Code - 10 cm

98510208



Color

- 3 Gold
- 4 Corten
- 5 White
- 7 Grey
- 9 Black

Led

- 1 4000°K
- 6 3000°K

SCHERMI



1 Satinato

4 Curvo

5 Prismatico

**Il codice del prodotto è riferito
a 10 cm di sospensione.
In fase d'ordine precisare
la misura della sospensione richiesta.**

Code number refer to 10 cm of suspension.
Ordering specify the length of the suspension required.

ACCESSORI CODE 98510108

Dettagli pag 22

9895

Schermo
antiabbagliamento

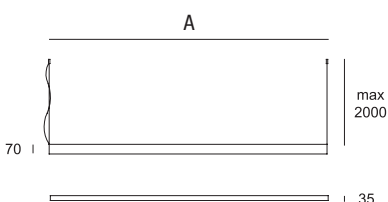

A: Color: 4-5-7-9 max cm 300 - 3 max cm 200





OMICRON LED SOSPENSIONE 220/240

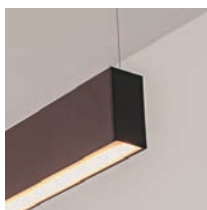

OMICRON SOSPENSIONE
1+1 LINEE LED

240 led/mt 19,2 w/mt
Lm/m 1540+1540/1580+1580
24 Vdc CRI90 **A** SDCM3

30.000h $-20^{\circ} + 40^{\circ}$ cm 2,5

Code - 10 cm

98511108



Color

- 3 Gold
- 4 Corten
- 5 White
- 7 Grey
- 9 Black

Led

- 1 4000°K
- 6 3000°K

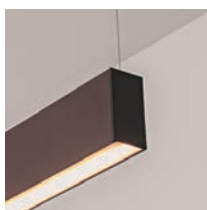

OMICRON SOSPENSIONE
1+2 LINEE LED

240 led/mt 19,2 w/mt
Lm/m 1540+3080/1580+3160
24 Vdc CRI90 **A** SDCM3

30.000h $-20^{\circ} + 40^{\circ}$ cm 2,5

Code - 10 cm

98511208



Color

- 3 Gold
- 4 Corten
- 5 White
- 7 Grey
- 9 Black

Led

- 1 4000°K
- 6 3000°K

SCHERMI



1 Satinato

4 Curvo

5 Prismatico

Cavi colorati a richiesta
Coloured cables on demand

- 5 White
- 8 Red
- 9 Black

ACCESSORI CODE 98511108

Dettagli pag 22

9895
Schermo
antiabbagliamento

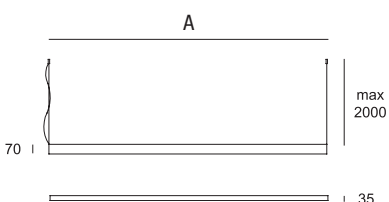

A: Color: 4-5-7-9 max cm 300 - 3 max cm 200



OMICRON applique

Design Athena

Lampade da parete realizzate in alluminio estruso disponibili in 5 misure, finitura bianca, nera o grigia, gold e corten. Le appliques possono essere congiunte tra loro con l'apposito accessorio.

Wall lamps available in 5 sizes, in 5 colours (white, black, grey, gold and corten). Wall lamps may be connected in a continuous line by apposite junction kit.



APPLIQUE LED 350 220/240V

Code	Color	Led SMD2835 SDCM 3			
98610121	3 Gold	1 LINEA LED			
	4 Corten	1 4000°K 7W 999 lm			
	5 White	6 3000°K 7W 936 lm			
	7 Grey				
	9 Black				
98610221	3 Gold 4 Corten 5 White 7 Grey 9 Black	2 LINEE LED			
		1 4000°K 13W 1998 lm			
		6 3000°K 13W 1872 lm			
98611121	3 Gold 4 Corten 5 White 7 Grey 9 Black	1+1 LINEA LED			
		1 4000°K 13W 999+777 lm			
98611221	3 Gold 4 Corten 5 White 7 Grey 9 Black	1+2 LINEE LED			
		1 4000°K 18,5W 777+1998 lm			
		6 3000°K 18,5W 728+1872 lm			

350
| 70
| 35

Led CRI >90

IP 40

APPLIQUE LED 600 220/240V

Code	Color	Led SMD2835 SDCM 3			
98610122	3 Gold	1 LINEA LED			
	4 Corten	1 4000°K 12W 1776 lm			
	5 White	6 3000°K 12W 1664 lm			
	7 Grey				
	9 Black				
98610222	3 Gold 4 Corten 5 White 7 Grey 9 Black	2 LINEE LED			
		1 4000°K 24W 3552 lm			
		6 3000°K 24W 3328 lm			
98611122	3 Gold 4 Corten 5 White 7 Grey 9 Black	1+1 LINEA LED			
		1 4000°K 24W 1776+1665 lm			
98611222	3 Gold 4 Corten 5 White 7 Grey 9 Black	1+2 LINEE LED			
		1 4000°K 35W 1665+3552 lm			
		6 3000°K 35W 1560+3328 lm			

600
| 70
| 35

Led CRI >90

IP 40

APPLIQUE LED 900 220/240V

Code	Color	Led SMD2835 SDCM 3			
98610123	3 Gold	1 LINEA LED			
	4 Corten	1 4000°K 19W 2775 lm			
	5 White	6 3000°K 19W 2600 lm			
	7 Grey				
	9 Black				
98610223	3 Gold 4 Corten 5 White 7 Grey 9 Black	2 LINEE LED			
		1 4000°K 38W 5550 lm			
		6 3000°K 38W 5200 lm			
98611123	3 Gold 4 Corten 5 White 7 Grey 9 Black	1+1 LINEA LED			
		1 4000°K 38W 2775+2664 lm			
98611223	3 Gold 4 Corten 5 White 7 Grey 9 Black	1+2 LINEE LED			
		1 4000°K 56W 2664+5550 lm			
		6 3000°K 56W 2496+5200 lm			

900
| 70
| 35

Led CRI >90

IP 40

A richiesta misure personalizzate/Custom measurements on demand



Code KIT CONGIUNZIONE

9862

Le applique possono essere congiunte in linea fra loro con il kit congiunzione 9862.
Wall lamp may be connected in a continuous line by junction 9862.

APPLIQUE LED 1500 220/240V

Code	Color	Led SMD2835 SDCM 3			
98610124	3 Gold	1 LINEA LED			
	4 Corten	1 4000°K 31W 4662 lm			
	5 White	6 3000°K 31W 4368 lm			
	7 Grey				
98610224	9 Black	2 LINEE LED			
		1 4000°K 62W 9324 lm			
		6 3000°K 62W 8736 lm			
98611124		1+1 LINEA LED			
		1 4000°K 62W 4440+4662 lm			
		6 3000°K 62W 4160+4368 lm			
98611224		1+2 LINEE LED			
		1 4000°K 92W 4440+9324 lm			
		6 8000°K 92W 4160+8736 lm			

1500
70
35
Led CRI >90 **A**
 IP 40

APPLIQUE LED 2000 220/240V

Code	Color	Led SMD2835 SDCM 3			
98610125	3 Gold	1 LINEA LED			
	4 Corten	1 4000°K 41W 6216 lm			
	5 White	6 3000°K 41W 5824 lm			
	7 Grey				
98610225	9 Black	2 LINEE LED			
		1 4000°K 82W 12432 lm			
		6 3000°K 82W 11648 lm			
98611125		1+1 LINEA LED			
		1 4000°K 82W 5883+6216 lm			
		6 3000°K 82W 5512+5824 lm			
98611225		1+2 LINEE LED			
		1 4000°K 121W 5583+12432 lm			
		6 3000°K 121W 5512+11648 lm			

2000
70
35
Led CRI >90 **A**
 IP 40

A richiesta misure personalizzate/Custom measurements on demand



Code _____ KIT CONGIUNZIONE

9862 _____

Le applique possono essere congiunte in linea fra loro con il kit congiunzione 9862.
Wall lamp may be connected in a continuous line by junction 9862.



INCROCIO

Design Athena

Serie di sospensioni, plafoniere ed applique LED realizzate in alluminio con finitura bianca, nera e grigia. Alimentatore incluso.

Collection of suspension, ceiling and wall lamps LED available in 3 colours (white, grey and black). Driver included.

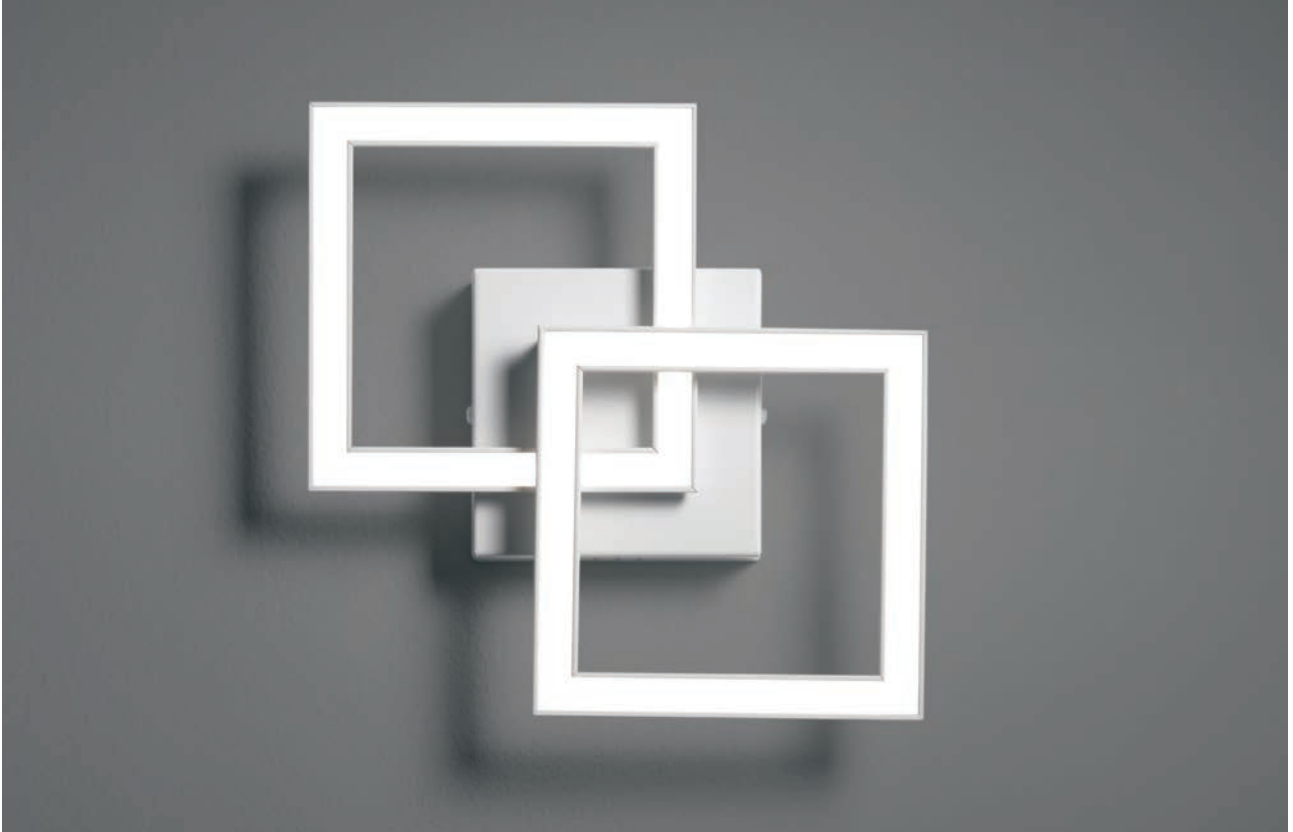

APPLIQUE/PLAFONE LED 24W 220/240V

Code	Color	Led
59161	5 White	1 4000°K 1890 lm
	7 Grey	6 3000°K 1845 lm
	9 Black	

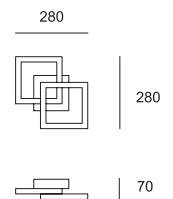

Led CRI 90 CE IP 20 1120

APPLIQUE/PLAFONE LED 12W 220/240V



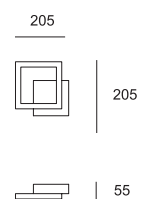

Code	Color	Led
59162	5 White	1 4000°K 948 lm
	7 Grey	6 3000°K 924 lm
	9 Black	



Led CRI 90 CE IP 20 800





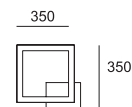

APPLIQUE/PLAFONE LED 23,5W 220/240V

Code	Color	Led
59122	5  White	1  4000°K 1896 lm
	7  Grey	6  3000°K 1848 lm
	9  Black	





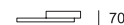

APPLIQUE/PLAFONE LED 45W 220/240V

Code	Color	Led
59222	5  White	1  4000°K 3634 lm
	7  Grey	6  3000°K 3542 lm
	9  Black	





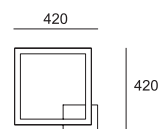

Led CRI 90  CE IP 20     **59122** **59222**
1650 1720

APPLIQUE/PLAFONE LED 29W 220/240V

Code	Color	Led
59124	5  White	1  4000°K 2370 lm
	7  Grey	6  3000°K 2310 lm
	9  Black	







APPLIQUE/PLAFONE LED 56W 220/240V

Code	Color	Led
59224	5  White	1  4000°K 4582 lm
	7  Grey	6  3000°K 4466 lm
	9  Black	





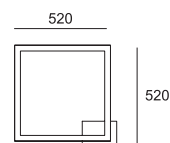

Led CRI 90  CE IP 20     **59124** **59224**
1890 1980

APPLIQUE/PLAFONE LED 37W 220/240V

Code	Color	Led
59126	5  White	1  4000°K 3000 lm
	7  Grey	6  3000°K 2926 lm
	9  Black	



APPLIQUE/PLAFONE LED 72W 220/240V





Code	Color	Led
59226	5  White	1  4000°K 5846 lm
	7  Grey	6  3000°K 5696 lm
	9  Black	



Led CRI 90  CE IP 20     **59126** **59226**
2220 2530





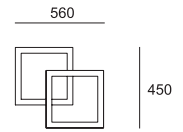

APPLIQUE/PLAFONE LED 47W 220/240V

Code	Color	Led
59121	5  White	1  4000°K 3790 lm
	7  Grey	6  3000°K 3690 lm
	9  Black	







APPLIQUE/PLAFONE LED 87W 220/240V

Code	Color	Led
59221	5  White	1  4000°K 7268 lm
	7  Grey	6  3000°K 7084 lm
	9  Black	





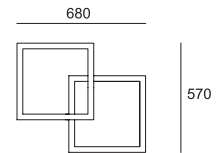

Led CRI 90  CE IP 20     **59121** **59221**
2130 2380

APPLIQUE/PLAFONE LED 58W 220/240V

Code	Color	Led
59123	5  White	1  4000°K 4740 lm
	7  Grey	6  3000°K 4620 lm
	9  Black	







APPLIQUE/PLAFONE LED 112W 220/240V

Code	Color	Led
59223	5  White	1  4000°K 9164 lm
	7  Grey	6  3000°K 8932 lm
	9  Black	





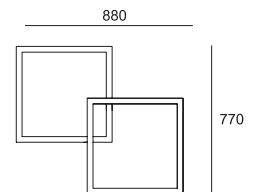

Led CRI 90  CE IP 20     **59123** **59223**
2800 3100

APPLIQUE/PLAFONE LED 73W 220/240V

Code	Color	Led
59125	5  White	1  4000°K 6000 lm
	7  Grey	6  3000°K 5850 lm
	9  Black	



APPLIQUE/PLAFONE LED 143W 220/240V

Code	Color	Led
59225	5  White	1  4000°K 11692 lm
	7  Grey	6  3000°K 11396 lm
	9  Black	



Led CRI 90  CE IP 20     **59126** **59226**
3380 3700





APPLIQUE/PLAFONE LED 62W 220/240V

Code	Color	Led
59127	5 White	1 4000°K 5056 lm
	7 Grey	6 3000°K 4928 lm
	9 Black	

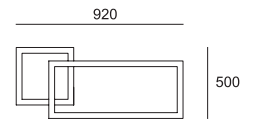

APPLIQUE/PLAFONE LED 121W 220/240V

Code	Color	Led
59227	5 White	1 4000°K 9950 lm
	7 Grey	6 3000°K 9700 lm
	9 Black	



Led CRI 90 IP 20 **59127** **59227**
3800 4240

APPLIQUE/PLAFONE LED 78W 220/240V

Code	Color	Led
59128	5 White	1 4000°K 6400 lm
	7 Grey	6 3000°K 6237 lm
	9 Black	

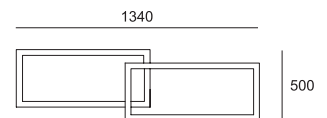

Led CRI 90 IP 20 **59128**
4680





SOSPENSIONE LED 70W 220/240V

Code	Color	Led
59151	5 White	1 4000°K UP 948 lm DOWN 4740 lm
	7 Grey	6 3000°K UP 924 lm DOWN 4620 lm
	9 Black	

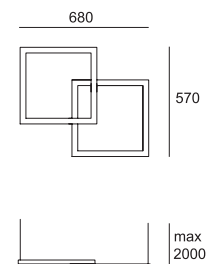

Led CRI 90 IP 20 3120

APPLIQUE/PLAFONE LED 89W 220/240V

Code	Color	Led
59152	5 White	1 4000°K UP 1311 lm DOWN 6000 lm
	7 Grey	6 3000°K UP 1278 lm DOWN 5852 lm
	9 Black	

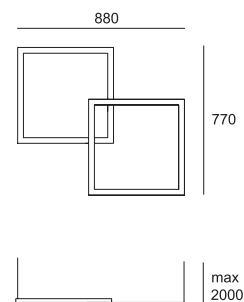

Led CRI 90 IP 20 3560



SOSPENSIONE LED 82W 220/240V

Code	Color	Led
59153	5 White	1 4000°K UP 1580 lm DOWN 5100 lm
	7 Grey	6 3000°K UP 1540 lm DOWN 4974 lm
	9 Black	

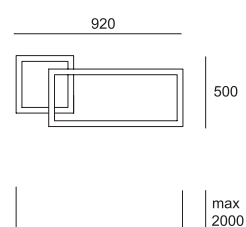

Led CRI 90 IP 20 3750

SOSPENSIONE LED 120W 220/240V

Code	Color	Led
59154	5 White	1 4000°K UP 3440 lm DOWN 6400 lm
	7 Grey	6 3000°K UP 3230 lm DOWN 6237 lm
	9 Black	

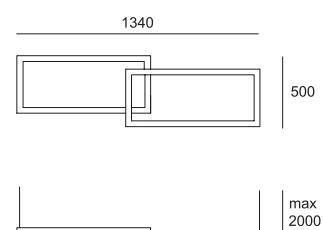

Led CRI 90 IP 20 4870

EDERA

Design Athena

Collezione di sospensioni in vetro disponibili nelle versioni trasparente e nei nuovi colori di tendenza pink gold e black chrome. L'ampia gamma di sorgenti luminose e dei contenitori di alimentazione permettono la massima versatilità della collezione. La lunghezza dei cavi permette di raggiungere i punti alimentazione in qualsiasi punto siano presenti nell'ambiente. La varietà dei modelli e delle combinazioni possibili rendono la collezione ottimale per ogni ambiente, sia domestico che lavorativo.

Glass hanging lights collection available in two different versions: transparent and in the new trending colours pink gold and black chrome. The wide range of light sources and of power containers allow the maximum versatility of the collection. The length of the cables allows to reach the power points whenever they are put in the location. The variety of the models and the possible combinations make the collection optimal for every location, whether it is home or work environment.



Sorgenti luminose
Lighting sources



**Code**

764730 cavo cm 300
764760 cavo cm 600

Color

1  Chrome

Glass

1  Clear
3  Pink Gold
9  Black Chrome



Lampadina 12 Vdc Led
G4 - G6,35

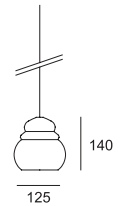

CE IP 20    
240



**Code**

764830 cavo cm 300
764860 cavo cm 600

Color

1  Chrome

Glass

1  Clear
3  Pink Gold
9  Black Chrome



Lampadina 12 Vdc Led
G4 - G6,35

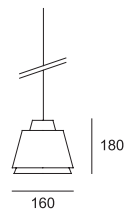

CE IP 20    
370

**Code**

763130 cavo cm 300
763160 cavo cm 600

Color

1  Chrome

Glass

1  Clear

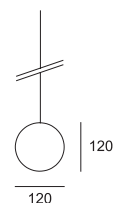

Lampadina 12 Vdc Led
G4 - G6,35

CE IP 20    
210

Sorgenti luminose
Lighting sources

**Code**

763530 cavo cm 300
763560 cavo cm 600

Color

1  Chrome

Glass

1  Clear
3  Pink Gold
9  Black Chrome



1 3 9

Lampadina 12 Vdc Led
G4 - G6,35

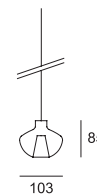

CE IP 20   
185

**Code**

764430 cavo cm 300
764460 cavo cm 600

Color

1  Chrome

Glass

1  Clear
3  Pink Gold
9  Black Chrome

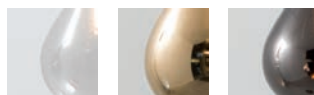

1 3 9

Lampadina 12 Vdc Led
G4 - G6,35

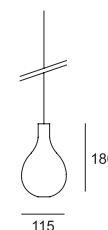

CE IP 20   
205

**Code**

764630 cavo cm 300
764660 cavo cm 600

Color

1  Chrome

Glass

1  Satined

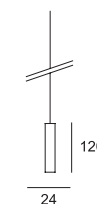

Lampadina 12 Vdc Led
G4 - G6,35

CE IP 20   
120



Sorgenti luminose
Lighting sources

**Code**

764930 cavo cm 300
764960 cavo cm 600

Color

1 Chrome

Glass

1 Clear
3 Pink Gold
9 Black Chrome

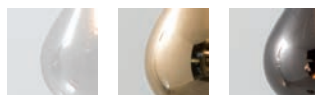

1

3

9

Lampadina 12 Vdc Led
G4 - G6,35

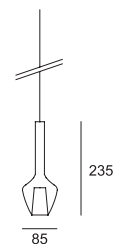

CE IP 20 250

**Code**

763930 cavo cm 300
763960 cavo cm 600

Color

1 Chrome

Glass

1 Satined

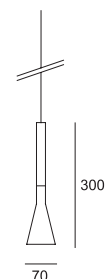

Lampadina 12 Vdc Led
G4 - G5,3 - G6,35

CE IP 20 235

**Code**

764030 cavo cm 300
764060 cavo cm 600

Color

1 Chrome

Glass

1 Satined

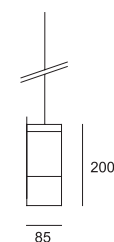

Lampadina 12 Vdc Led
G4 - G5,3 - G6,35

CE IP 20 370





ACCESSORI EDERA

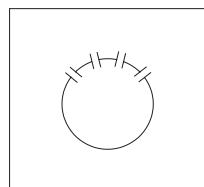

**Contenitore 4 fori uscita cavi - 75W 12Vdc
max 12 sospensioni**

Container 75W 12Vdc with 4 holes for cables exit;
max 12 suspensions

Ø 170 H 40

Code

Color

1280

5  White

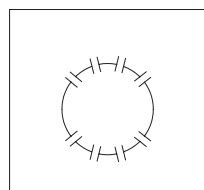

**Contenitore 8 fori uscita cavi - 75W 12Vdc
max 12 sospensioni**

Container 75W 12Vdc with 8 holes for cables exit;
max 12 suspensions

Ø 170 H 40

Code

Color

1281

5  White

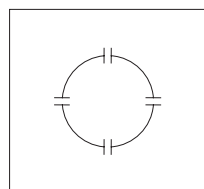

**Contenitore 4 fori uscita cavi - 75W 12Vdc
max 12 sospensioni**

Container 75W 12Vdc with 4 holes for cables exit;
max 12 suspensions

Ø 170 H 40

Code

Color

1282

5  White

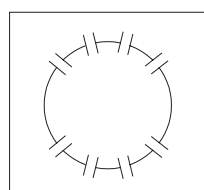

**Contenitore 8 fori uscita cavi - 150W 12Vdc
max 24 sospensioni**

Container 150W 12Vdc with 8 holes for cables exit;
max 24 suspensions

Ø 220 H 45

Code

Color

1283

5  White

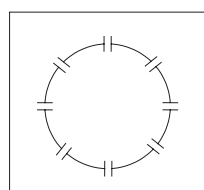

**Contenitore 8 fori uscita cavi - 150W 12Vdc
max 24 sospensioni**

Container 150W 12Vdc with 8 holes for cables exit;
max 24 suspensions

Ø 220 H 45

Code

Color

1284

5  White

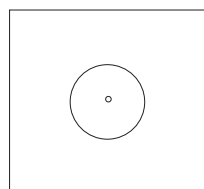

Rosone 1 uscita 10W 12Vdc

Container with 10W 12Vdc with 1 hole for cable exit

Ø 125 H 30

Code

Color

1287

5  White

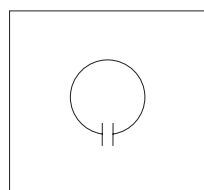

**Rosone 1 uscita laterale 10W 12Vdc
max 3 sospensioni**

Container with 10W 12Vdc with 1 side hole for cable exit
max 3 suspensions

Ø 125 H 30

Code

Color

1288

5  White



Supporto per tenuta cavo

Support for cable

Code

Color

7003

1  Chrome



ESEMPI COMPOSIZIONI EDERA

APPLICAZIONI A SOFFITTO

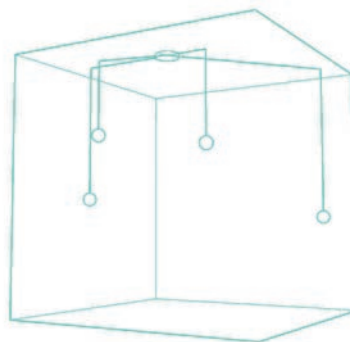
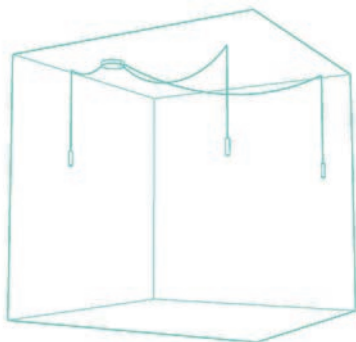

APPLICAZIONI A PARETE

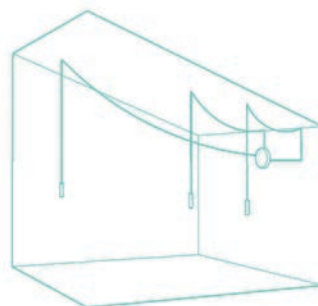
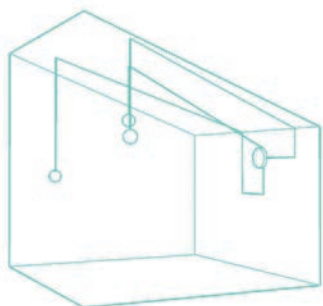
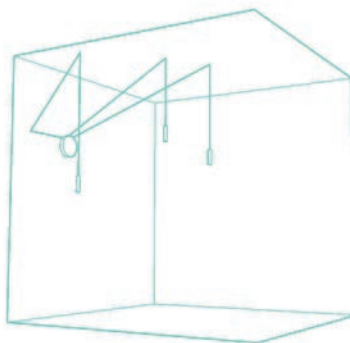
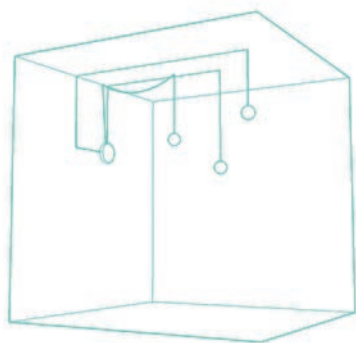

DADAJE

Design Athena

Collezione di applique LED da parete e plafone disponibili nelle finitura bianco, nero, grigio, oro e corten.

Collection of wall and ceiling LED lamps with white, black, grey, gold and corten finishing.



APPLIQUE LED

Sorgente Led 2x4,5W - 220/240v dimmerabile

Code	Color	Led
5221	3 Gold	1 4000°K 500+500 lm
	4 Corten	6 3000°K 460+460 lm
	5 White	
	7 Grey	
	9 Black	

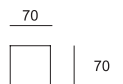

Led CRI >80 IP 40 320

APPLIQUE LED

Sorgente Led 2x12W - 220/240v dimmerabile

Code	Color	Led
5321	3 Gold	1 4000°K 1210+1210 lm
	4 Corten	6 3000°K 1000+1000 lm
	5 White	
	7 Grey	
	9 Black	

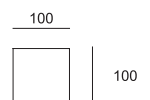

Led CRI >80 IP 40 570





APPLIQUE ORIENTABILE
Sorgente Led 1x8,7W - 220/240v dimmerabile

Code	Color	Led
5261	3 Gold	1 4000°K 800 lm
	4 Corten	6 3000°K 650 lm
	5 White	
	7 Grey	
	9 Black	

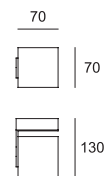



APPLIQUE/PLAFONIERA LED
Sorgente Led 2x8,7W - 220/240v dimmerabile

Code	Color	Led
5262	3 Gold	1 4000°K 1600 lm
	4 Corten	6 3000°K 1300 lm
	5 White	
	7 Grey	
	9 Black	

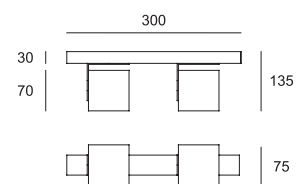

Ⓡ Led CRI >80 A+ CE IP 40 ⚡ ⚡ ⚡ GR 1220

APPLIQUE/PLAFONIERA LED
Sorgente Led 3x8,7W - 220/240v dimmerabile

Code	Color	Led
5263	3 Gold	1 4000°K 2400 lm
	4 Corten	6 3000°K 1950 lm
	5 White	
	7 Grey	
	9 Black	

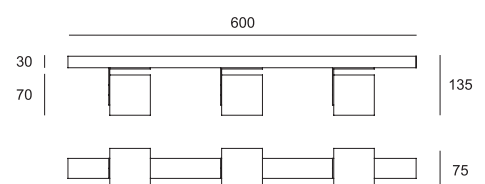

Ⓡ Led CRI >80 A+ CE IP 40 ⚡ ⚡ ⚡ GR 1915



PLAFONIERA LED

Sorgente Led 1x8,7W - 220/240v dimmerabile

Code	Color	Led
5291	3 Gold	1 4000°K 800 lm
	4 Corten	6 3000°K 650 lm
	5 White	
	7 Grey	
	9 Black	

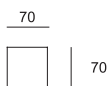

Led CRI >80
 CE IP 40

PLAFONIERA LED

Sorgente Led 1x12W - 220/240v dimmerabile

Code	Color	Led
5391	3 Gold	1 4000°K 1210 lm
	4 Corten	6 3000°K 1000 lm
	5 White	
	7 Grey	
	9 Black	

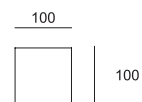

Led CRI >80
 CE IP 40

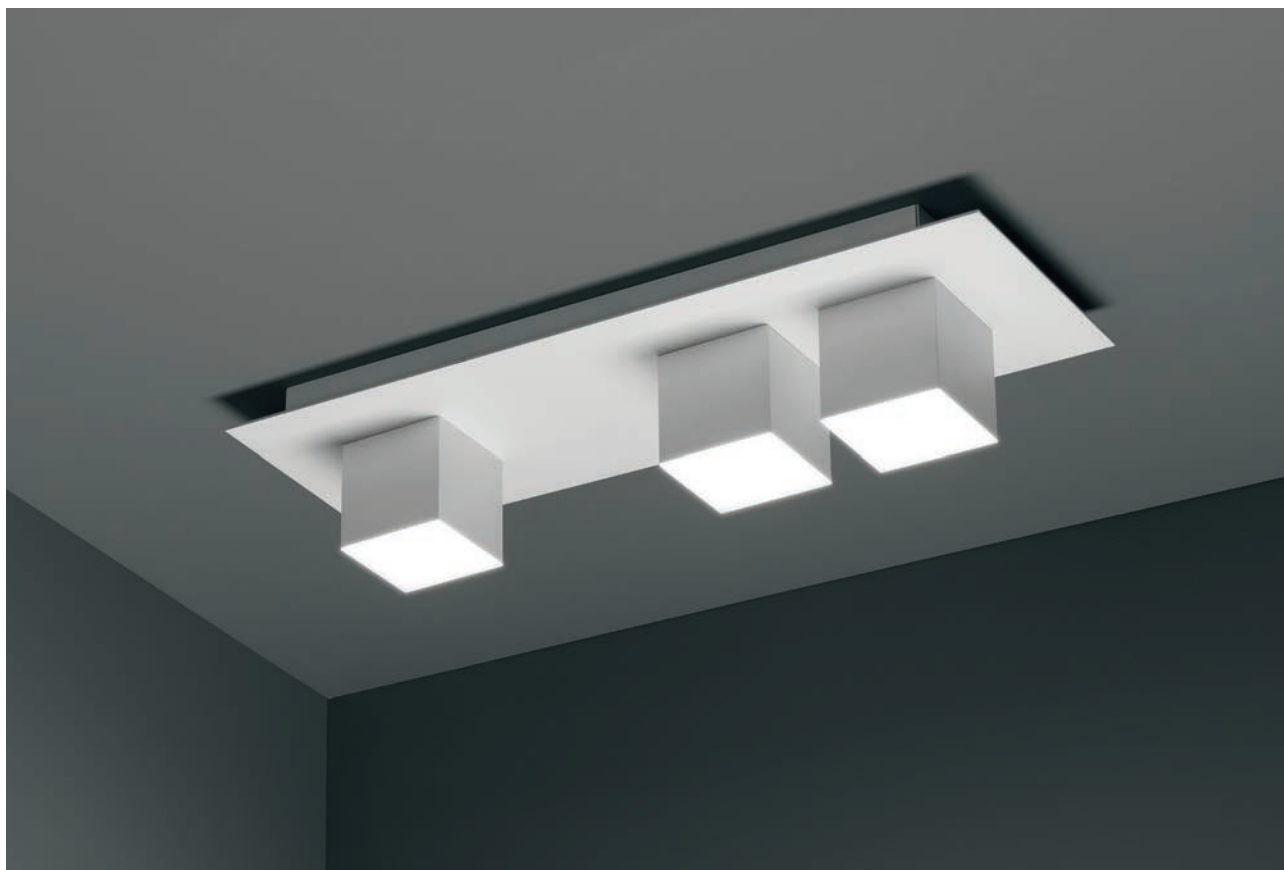

PLAFONIERA LED
Sorgente Led 3x8,7W - 220/240v dimmerabile

Code	Color	Led
5271	3 Gold	1 4000°K 2400 lm
	4 Corten	6 3000°K 1950 lm
	5 White	
	7 Grey	
	9 Black	

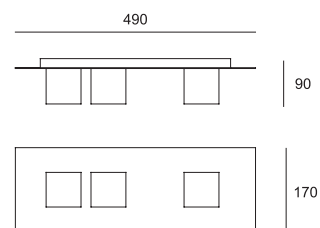

Led CRI >80 IP 40 2160

PLAFONIERA LED
Sorgente Led 2x8,7W - 220/240v dimmerabile

Code	Color	Led
5272	3 Gold	1 4000°K 1600 lm
	4 Corten	6 3000°K 1300 lm
	5 White	
	7 Grey	
	9 Black	

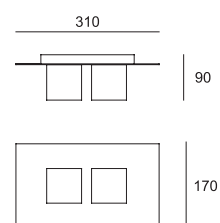

Led CRI >80 IP 40 1780



PLAFONIERA LED

Sorgente Led 41,4W - 220/240v dimmerabile

Code	Color	Led
5282	3 Gold	1 4000°K 4010 lm
	4 Corten	6 3000°K 3300 lm
	5 White	
	7 Grey	
	9 Black	

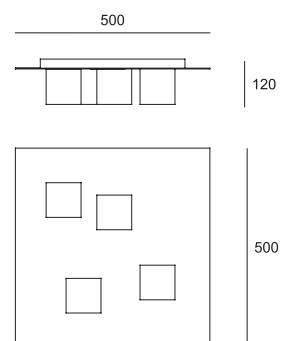

Led CRI >80

SOSPENSIONE LED

Sorgente Led 8,7W - 220/240v dimmerabile

Code	Color	Led
5401	3 Gold	1 4000°K 800 lm
	4 Corten	6 3000°K 600 lm
	5 White	
	7 Grey	
	9 Black	

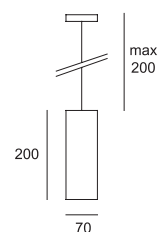

Led CRI >80

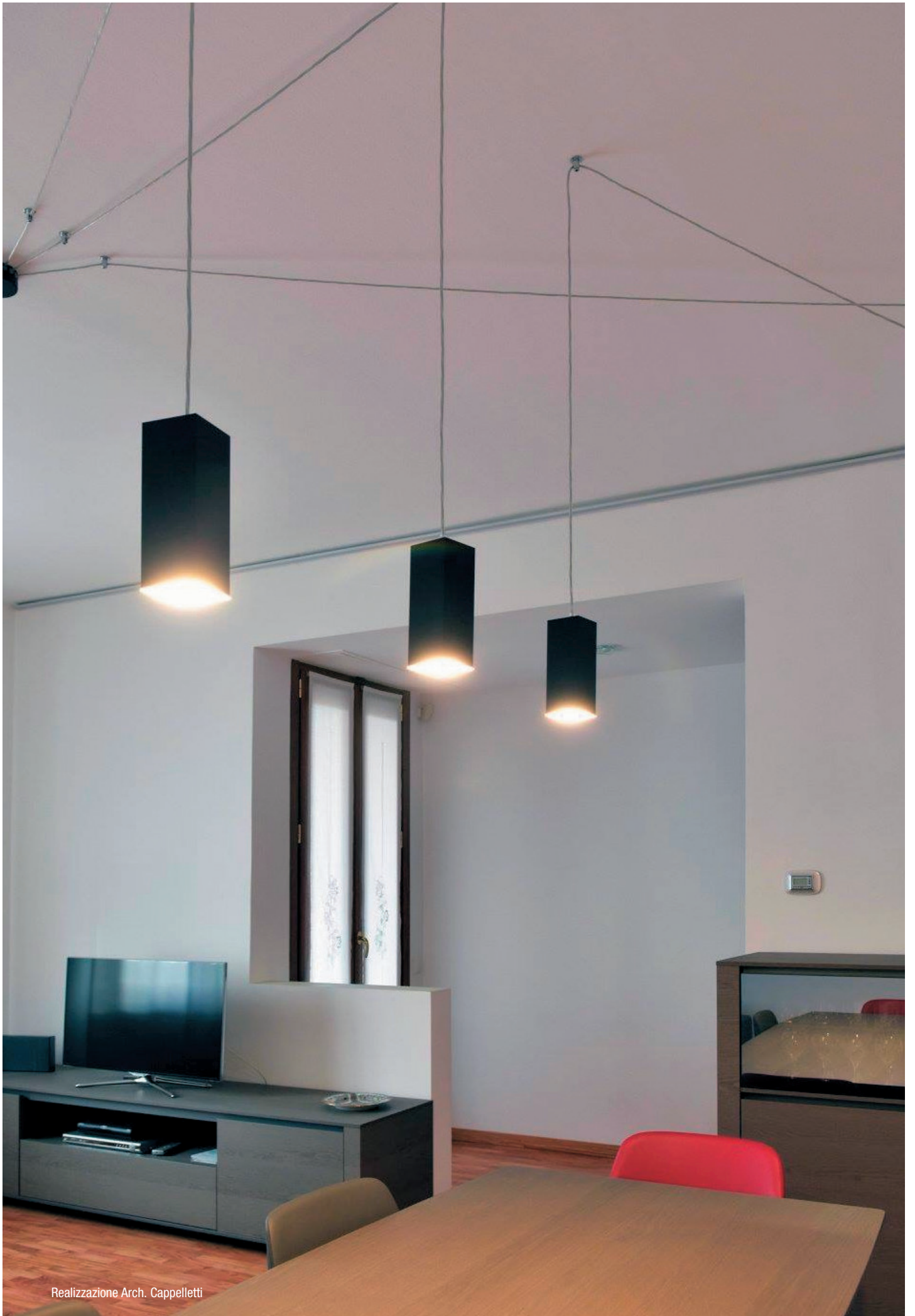

GIOTTO

Design Athena

Serie di sospensioni circolari combinabili tra loro, realizzate in alluminio con finitura bianca o oro e montate con led da 19,2 w/m. Luce naturale, calda. Le sospensioni devono essere completate con il contenitore con l'alimentatore.

Circular suspensions combined together, made of white or gold painted aluminium and fitted with 19,2 w/mt strip LED natural and warm. Suspensions have to be completed with its appropriate box with driver.



COMPOSIZIONI

Gli elementi a sospensione, di qualsiasi dimensione, possono essere combinati tra loro in base alle proprie esigenze. La composizione degli elementi deve essere completata con il contenitore con alimentatore appropriato alla potenza totale.

Suspensions, of any size, can be combined together to suit your needs. Compositions must be completed with the appropriate box with driver.

SOSPENSIONE LED 390 - 23,1W 24 VDC

Code	Color	Led
775119	3  Gold	1  4000°K 1900 lm
	5  White	6  3000°K 1850 lm

SOSPENSIONE LED 520 - 30,7W 24VDC

Code	Color	Led
775219	3  Gold	1  4000°K 2530 lm
	5  White	6  3000°K 2460 lm

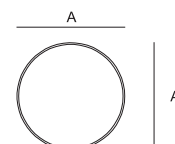

SOSPENSIONE LED 640 - 38,4W 24VDC

Code	Color	Led
775319	3  Gold	1  4000°K 3160 lm
	5  White	6  3000°K 3080 lm



SOSPENSIONE LED 860 - 51,5W 24VDC

Code	Color	Led
775419	3  Gold	1  4000°K 4230 lm
	5  White	6  3000°K 4130 lm

A	Code	Ø	Weight
	775119	Ø 390	460gr
	775219	Ø 520	550gr
	775319	Ø 640	650gr
	775419	Ø 860	710gr

Led CRI >90   IP 40 

SOSPENSIONE LED 1400 - 82W 24VDC

Code	Color	Led
775519	3  Gold	1  4000°K 6740 lm
	5  White	6  3000°K 6576 lm

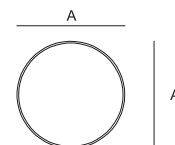

SOSPENSIONE LED 1600 - 94W 24 VDC

Code	Color	Led
775619	3  Gold	1  4000°K 7740 lm
	5  White	6  3000°K 7545 lm

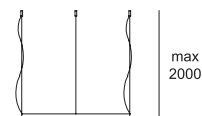

A	Code	Ø	Weight
	775519	Ø 1400	1320gr
	775619	Ø 1600	1480gr
	775719	Ø 1800	1560gr

SOSPENSIONE LED 1800 - 109W 24VDC

Code	Color	Led
775719	3  Gold	1  4000°K 8960 lm
	5  White	6  3000°K 8740 lm

Led CRI >90   IP 40 



ESEMPI DI COMPOSIZIONI

Gli elementi a sospensione, di qualsiasi dimensione, possono essere combinati tra loro in base alle proprie esigenze.

Suspensions, of any size, can be combined together to suit your needs.

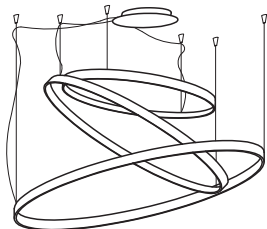

Sospensione a 3 cerchi, 69,8w totale, con scatola alimentazione dimmerabile push:
Suspensions composed by 3 circles lamps, 69,8w, with dimmable power supply:

775119 5 - sospensione tonda diametro 390 mm

775219 5 - sospensione tonda diametro 520 mm

775319 5 - sospensione tonda diametro 640 mm

1285 D - contenitore con alimentatore max 150w dimmerabile con push

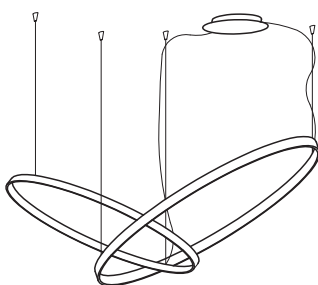

Sospensione a 2 cerchi, 40,8w totale, con scatola alimentazione:

Suspensions composed by 2 circles lamps, 40,8w:

775119 5 - sospensione tonda diametro 390 mm

775219 5 - sospensione tonda diametro 520 mm

1280 - contenitore con alimentatore max 75w

ACCESSORI

CONTENITORE 24VDC 75W max

Code _____ **Color** _____

1280

3  Gold
5  White

CE IP 20  
680

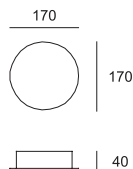

CONTENITORE 24VDC 150W max

Code _____ **Color** _____

1285

1285D dimmerable push

3  Gold
5  White

CE IP 20  
1465

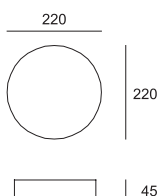

Sospensioni complete di cerchi e rosone con alimentatore.
Suspension complete with circle lamps and canopy with power supply.



SOSPENSIONE LED 69,1W 220/240V

Code	Color	Led
776019	3 Gold	1 4000°K 5690 lm
	5 White	6 3000°K 5540 lm

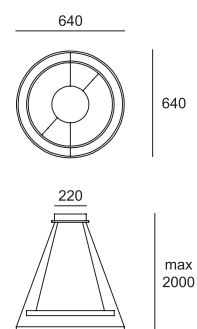

Led CRI 90 CE IP 40

SOSPENSIONE LED 92,5W 220/240V

Code	Color	Led
776119	3 Gold	1 4000°K 7590 lm
	5 White	6 3000°K 7390 lm

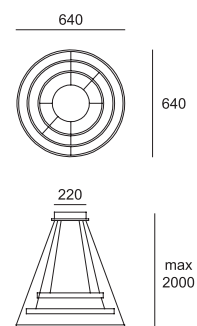

Led CRI 90 CE IP 40







APPLIQUE LED 23,1W 220/240V

Code	Color	Led
776219	3  Gold	1  4000°K 1900 lm
	5  White	6  3000°K 1850 lm

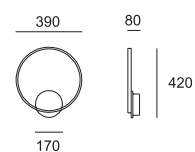

Led CRI 90  CE IP 40    





COMPOSIZIONI

Gli elementi a plafone o parete, di qualsiasi dimensione, possono essere combinati tra loro.





La composizione degli elementi deve essere completata con il contenitore con alimentatore appropriato alla potenza totale.

Wall or ceiling elements, of any size, can be combined together to suit your needs. Compositions must be completed with the appropriate box with driver.





APPLIQUE/PLAFONE LED 390 - 23,1W 24VDC

Code	Color	Led	Distanziale
772119	3  Gold	1  4000°K 1900 lm	1 mm 70
	5  White	6  3000°K 1850 lm	2 mm 100 3 mm 125





APPLIQUE/PLAFONE LED 520 - 30,7W 24VDC

Code	Color	Led	Distanziale
772219	3  Gold	1  4000°K 2530 lm	1 mm 70
	5  White	6  3000°K 2460 lm	2 mm 100 3 mm 125

APPLIQUE/PLAFONE LED 640 - 38,4W 24VDC

Code	Color	Led	Distanziale
772319	3  Gold	1  4000°K 3160 lm	1 mm 70
	5  White	6  3000°K 3080 lm	2 mm 100 3 mm 125

APPLIQUE/PLAFONE LED 860 - 51,5W 24VDC

Code	Color	Led	Distanziale
772419	3  Gold	1  4000°K 4230 lm	1 mm 70
	5  White	6  3000°K 4130 lm	2 mm 100 3 mm 125

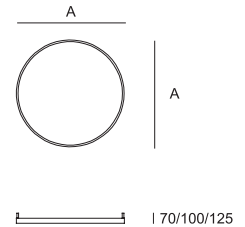

A	772119	Ø 390	460gr
	772219	Ø 520	550gr
	772319	Ø 640	650gr
	772419	Ø 860	710gr

Led CRI >90   IP 40 

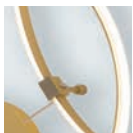

In fase d'ordine precisare la misura del distanziale parete/soffitto
1 - mm 70 | 2 - mm 100 | 3 - mm 125

ACCESSORI

CONTENITORE 24VDC 75W max

Code	Color
1282	3  Gold
	5  White

CE IP 20  

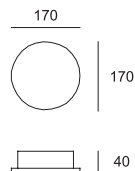

CONTENITORE 24VDC 150W max

Code	Color
1286	3  Gold
	5  White

CE IP 20  

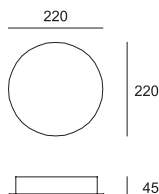



DEGAS

Design Athena

Serie di sospensioni a LED, realizzate in alluminio con finitura bianca, nera e grigia. Montate con strip led 19,2w. Scatola alimentazione inclusa.

Series of suspensions lamps LED, made of aluminum with white, black and grey finishing. Assembled with 19.2w LED strip. Power Supply included.



MISURE/ CUSTOM

Tutte le sospensioni e plafoniere della collezione DEGAS possono essere realizzate con misure personalizzate.

All the hanging and the ceiling lights of the DEGAS collection can be realised with tailored measures.



SOSPENSIONE LED 57W 220/240V

Code	Color	Led
905119	5 White	1 4000°K UP 1580 - DOWN 3160
	7 Grey	6 3000°K UP 1540 - DOWN 3080
	9 Black	

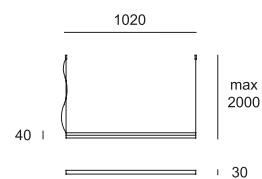

Led CRI 90 IP 20 2310

SOSPENSIONE LED 114W 220/240V

Code	Color	Led
905419	5 White	1 4000°K UP 3160 - DOWN 6320
	7 Grey	6 3000°K UP 3080 - DOWN 6160
	9 Black	

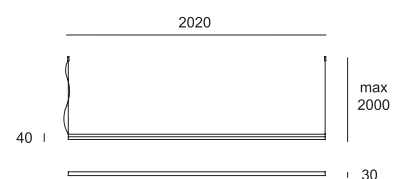

Led CRI 90 IP 20 3590

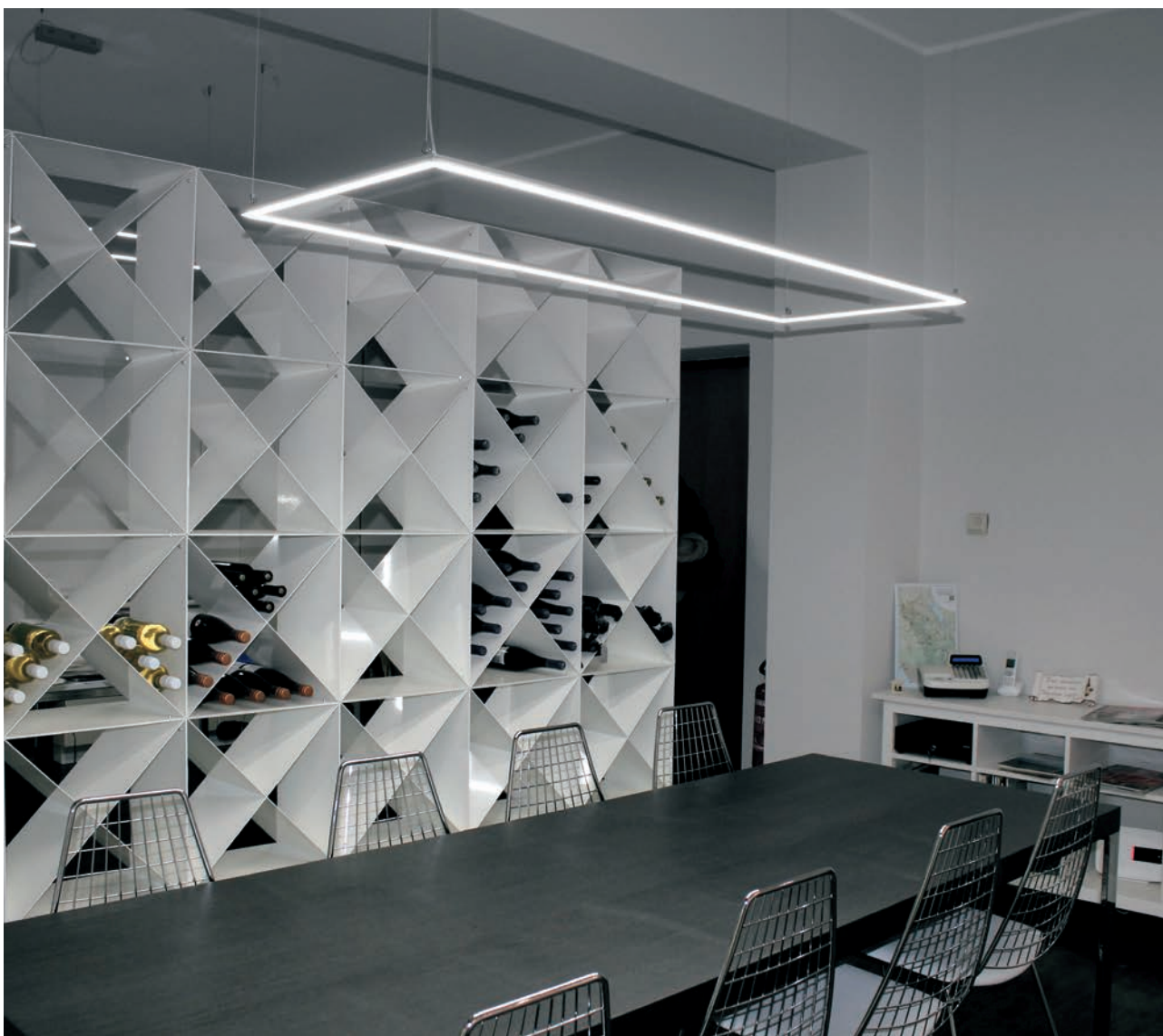

SOSPENSIONE LED 48W 220/240V

Code	Color	Led
905219	5 White 7 Grey 9 Black	1 4000°K 3950 lm 6 3000°K 3850 lm

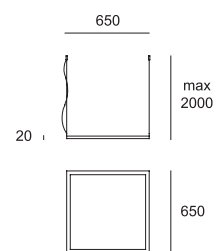

Led CRI 90 CE IP 20 2410

SOSPENSIONE LED 60W 220/240V

Code	Color	Led
905319	5 White 7 Grey 9 Black	1 4000°K 4740 lm 6 3000°K 4620 lm

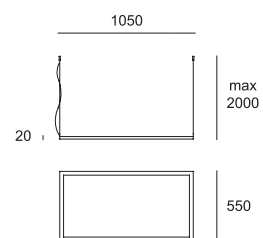

Led CRI 90 CE IP 20 2790



SOSPENSIONE LED 72W 220/240V

Code	Color	Led
905519	5 White	1 4000°K UP 2050 - DOWN 3950
	7 Grey	6 3000°K UP 2000 - DOWN 3800
	9 Black	

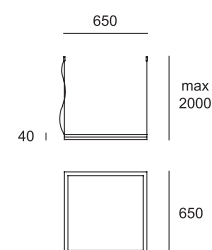

Led CRI 90 CE IP 20 4410





SOSPENSIONE LED 99W 220/240V

Code	Color	Led
905619	5 White	1 4000°K UP 3160 - DOWN 4930
	7 Grey	6 3000°K UP 3080 - DOWN 4800
	9 Black	

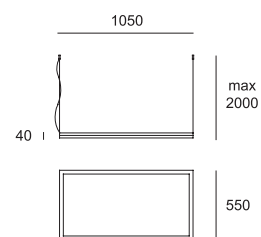

Led CRI 90 CE IP 20



LAMPADA TERRA LED 48W 220/240V

Code	Color	Led
908019	5 White	1 4000°K 3950 lm
	7 Grey	6 3000°K 3850 lm
	9 Black	

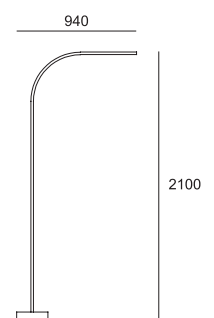

Led CRI 90 IP 20 5620

LAMPADA PARETE 38,4W 220/240V

Code	Color	Led
908119	5 White	1 4000°K 3160 lm
	7 Grey	6 3000°K 3080 lm
	9 Black	

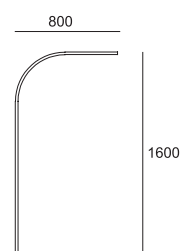

Led CRI 90 IP 20 1620







LAMPADA TERRA LED 57,6W per lato 220/240V

Code	Color	Led
908619	5 White	1 4000°K 9480 lm
	7 Grey	6 3000°K 9240 lm
	9 Black	

Led CRI 90 IP 20 7580



LAMPADA TERRA LED 57,6W per lato 220/240V

Code	Color	Led
908219	5 White	1 4000°K 9480 lm
	7 Grey	6 3000°K 9240 lm
	9 Black	

245

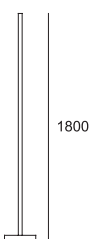

Led CRI 90 IP 20 7580



MONET

Design Athena

Collezione di plafoniere e sospensioni realizzate in PMMA lucido nella versione bianco e nero con punti luci led da 4,5W cadauno. La collezione è disponibile anche nella versione con dimmer con funzione di accensione, spegnimento e regolazione tramite push.

Collection of ceiling lamps and suspensions made by glossy PMMA. Available in white and black colour and spotted by 4,5w leds. The collection is also available with dimmer push controller.



PLAFONIERA LED 400 - 5x4,5W 220/240V

Code	Color	Led
8944	5  White	1  4000°K 2600 lm
	9  Black	6  3000°K 2400 lm

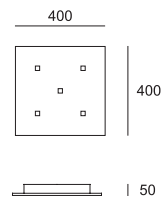

Led CRI >80  CE IP 20     2100

PLAFONIERA LED 500 - 9x4,5W 220/240V

Code	Color	Led
8945	5  White	1  4000°K 4680 lm
	9  Black	6  3000°K 4380 lm

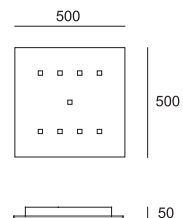

Led CRI >80  CE IP 20     2900

PLAFONIERA LED 600 - 12x4,5W 220/240V

Code	Color	Led
8946	5  White	1  4000°K 6240 lm
	9  Black	6  3000°K 5760 lm

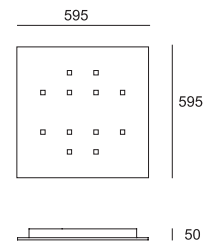

Led CRI >80  CE IP 20     4600

PLAFONIERA LED 1010 - 10x4,5W 220/240V

Code	Color	Led
8947	5  White	1  4000°K 5200 lm
	9  Black	6  3000°K 4800 lm

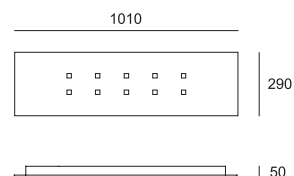

Led CRI >80  CE IP 20     4600

SOSPENSIONE LED 400 - 5x4,5W 220/240V

Code	Color	Led
8954	5 White	1 4000°K 2500 lm
	9 Black	6 3000°K 2300 lm

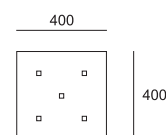

SOSPENSIONE LED BIEMISSIONE 400 - 5x4,5W + UP 1x12W 220/240V

Predisposta per doppia accensione - con accessorio 1299 accensione unica.

Predisposta per doppia accensione - con accessorio 1299 accensione unica.

Code	Color	Led
8974	5 White	1 4000°K 2500 + 1000 lm
	9 Black	6 3000°K 2300 + 940 lm

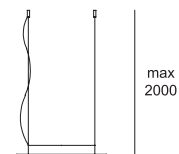

Led CRI >80 IP 20 **8954** **8974**
2370 2440

SOSPENSIONE LED 500 - 9x4,5W 220/240V

Code	Color	Led
8955	5 White	1 4000°K 4500 lm
	9 Black	6 3000°K 4140 lm

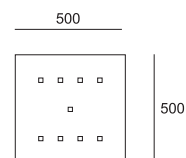

SOSPENSIONE LED BIEMISSIONE 500 - 9x4,5W + UP 1x12W 220/240V

Predisposta per doppia accensione - con accessorio 1299 accensione unica.

Predisposta per doppia accensione - con accessorio 1299 accensione unica.

Code	Color	Led
8975	5 White	1 4000°K 4500 + 1000 lm
	9 Black	6 3000°K 4140 + 940 lm

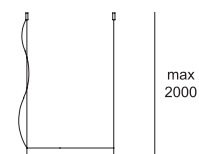

Led CRI >80 IP 20 **8955** **8975**
3200 3200



SOSPENSIONE LED 600 - 12x4,5W 220/240V

Code	Color	Led
8956	5 White	1 4000°K 6000 lm
	9 Black	6 3000°K 5520 lm

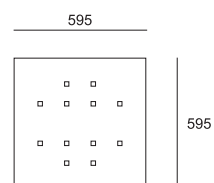

SOSPENSIONE LED BIEMISSIONE 600 - 12x4,5W + UP 1x12W

Code	Color	Led
8976	5 White	1 4000°K down 6000 lm up 1000 lm
	9 Black	6 3000°K down 5520 lm up 940 lm

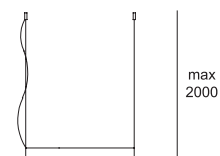

Led CRI >80 IP 20 **8956** **8976**
 4900 4970

SOSPENSIONE LED 1010 - 10x4,5W 220/240V

Code	Color	Led
8957	5 White	1 4000°K 5000 lm
	9 Black	6 3000°K 4600 lm

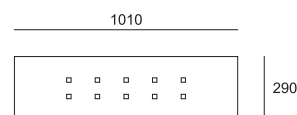

SOSPENSIONE LED BIEMISSIONE 1010 - 10x4,5W + UP 1x12W

Code	Color	Led
8977	5 White	1 4000°K down 5000 lm up 1000 lm
	9 Black	6 3000°K down 5600 lm up 940 lm

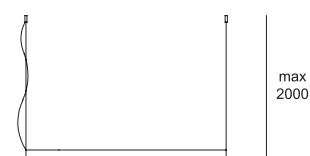

Led CRI >80 IP 20 **8957** **8977**
 4900 4970



PICASSO

Design Athena

Collezione di applique disponibili in 3 misure con biemissione o monoemissione.

La vasta gamma di colori della collezione ne permette l'utilizzo in ambienti commerciali, lavorativi e domestici e in contesti sia moderni che classici.

Collection of wall lamp available in 3 sizes with bidirectional or unidirectional light.

The wide range of colors of the collection allows the use in commercial, business and domestic contexts in both modern and classic.





APPLIQUE LED 3x4,5W 220/240V

Code	Color	Led
88611	1 Chrome	1 4000°K 1860 lm
	3 Gold	6 3000°K 1785 lm
	4 Corten	
	5 White	







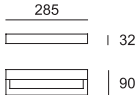

APPLIQUE LED 3x4,5W DOWN 1x4,5W 220/240V

Code	Color	Led
88612	1 Chrome	1 4000°K up 1860 lm down 620 lm
	3 Gold	6 3000°K up 1785 lm down 595 lm
	4 Corten	
	5 White	









APPLIQUE LED 1x10W 220/240V

Code	Color	Led
88621	1  Chrome	1  4000°K 1445 lm
	3  Gold	6  3000°K 1360 lm
	4  Corten	
	5  White	







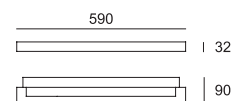

APPLIQUE LED 2x10W 220/240V

Code	Color	Led
88622	1  Chrome	1  4000°K 1445+1445 lm
	3  Gold	6  3000°K 1360+1360 lm
	4  Corten	
	5  White	







 Led CRI 90  CE IP 20   **88621** **88622**
 1230  1270

APPLIQUE LED 1x19,5W 220/240V

Code	Color	Led
88631	1  Chrome	1  4000°K 3000 lm
	3  Gold	6  3000°K 2830 lm
	4  Corten	
	5  White	



APPLIQUE LED 2x19,5W 220/240V

Code	Color	Led
88632	1  Chrome	1  4000°K 3000+3000 lm
	3  Gold	6  3000°K 2860+2860 lm
	4  Corten	
	5  White	

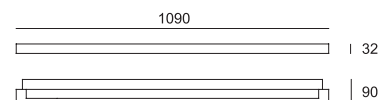
 Led CRI 90  CE IP 20   **88631** **88632**
 2390  2760



RIFLESSI



Design Athena

Collezione di plafoniere con vetro quadrato extra-chiaro. Il vetro è sabbato da entrambe le parti e trasparente nel riquadro centrale. Il riquadro centrale viene messo in risalto dagli inserti in vetro e dal fondo in alluminio a specchio. Prodotto nella versione LED da 4,5 W o 8,7 W.

A collection of ceiling light fixtures with extra-clear square glass. The glass is sanded on both sides and is transparent in the central panel. The central panel is put into relief by the glass inserts and by the aluminium back which is like a mirror. It comes in the version 4,5 W or 8,7 W LED.



PLAFONIERA LED 4x4,5W 220/240V

Code	Color	Led
5831	1  Chrome	1  4000°K 2000 lm 6  3000°K 1840 lm

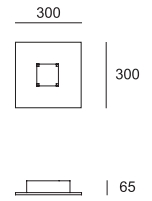

 Led CRI >80
  CE IP 20
 

 2550

PLAFONIERA LED 4x4,5W 220/240V

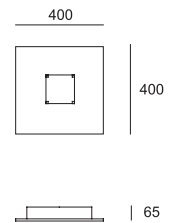

Code	Color	Led
5832	1  Chrome	1  4000°K 2000 lm 6  3000°K 1840 lm



 Led CRI >80
  CE IP 20
 

 4220

PLAFONIERA LED 4x8,7W 220/240V

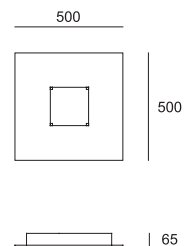

Code	Color	Led
5833	1  Chrome	1  4000°K 3200 lm 6  3000°K 2600 lm



 Led CRI >80
  CE IP 20
 

 6360

PLAFONIERA LED 4x8,7W 220/240V

Code	Color	Led
5834	1  Chrome	1  4000°K 3200 lm 6  3000°K 2600 lm

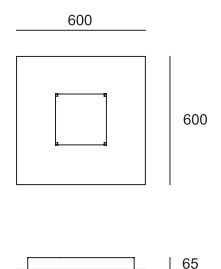

 Led CRI >80
  CE IP 20
 

 7890

KITE

Design Athena

Collezione di plafoniere, sospensioni in vetro extra chiaro trasparente sabbiato internamente. Particolari in policarbonato e finiture in acciaio lucido.

A collection of ceiling light fixtures, suspension light fixtures with extra-clear transparent/internal satinized glass. The details are poly-carbonate and the finishing of polished chrome steel.





SOSPENSIONE LED 51W 220/240V

Code	Color	Led
5854	1 Chrome	1 4000°K 5328 + 2442 lm 6 3000°K 4992 + 2288 lm

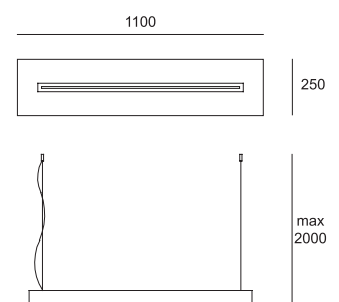

Led CRI 90 CE IP 20 GR 6270

PLAFONIERA LED 35W 220/240V

Code	Color	Led
5844	1 Chrome	1 4000°K 5328 lm 6 3000°K 4992 lm

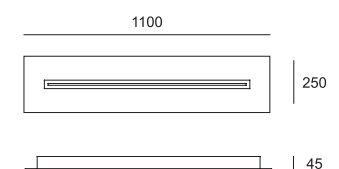

Led CRI 90 CE IP 20 GR 6150

MILO

Design Athena

Collezione di applique LED da parete e plafone disponibili nelle finitura bianco.

Collection of wall and ceiling LED lamps, white finishing.





APPLIQUE LED ORIENTABILE
Sorgente Led 1x8,7W - 220/240v dimmerabile

Code	Color	Led	Polycarbonate
5601	5 White	1 4000°K 800 lm	1 Trasparent
		6 2800°K 650 lm	7 Orange
			8 Red

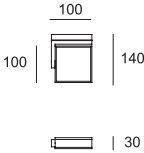

Led CRI >80 CE IP 40

APPLIQUE LED ORIENTABILE
Sorgente Led 1x12W - 220/240v dimmerabile

Code	Color	Led	Polycarbonate
5701	5 White	1 4000°K 1210 lm	1 Trasparent
		6 2800°K 1000 lm	7 Orange
			8 Red

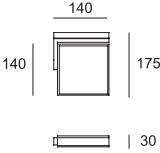

Led CRI >80 CE IP 40

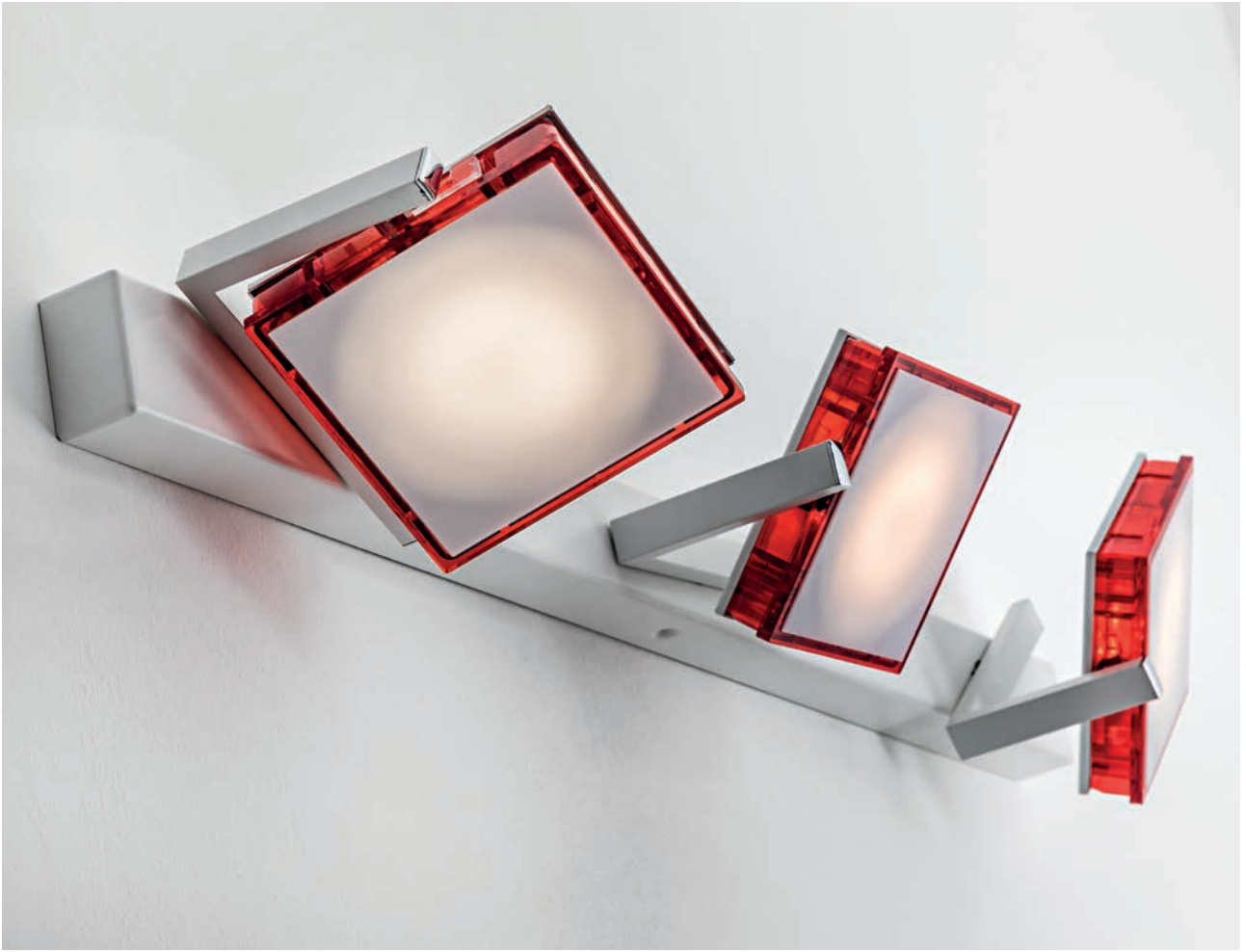

APPLIQUE/PLAFONE LED ORIENTABILE
Sorgente Led 2x8,7W - 220/240v dimmerabile

Code	Color	Led	Polycarbonate
5622	5 White	1 4000°K 1600 lm 6 2800°K 1300 lm	1 Trasparent 7 Orange 8 Red

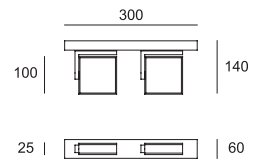

Led CRI >80 IP 40 640

APPLIQUE/PLAFONE LED ORIENTABILE
Sorgente Led 3x8,7W - 220/240v dimmerabile

Code	Color	Led	Polycarbonate
5623	5 White	1 4000°K 2400 lm 6 2800°K 1950 lm	1 Trasparent 7 Orange 8 Red

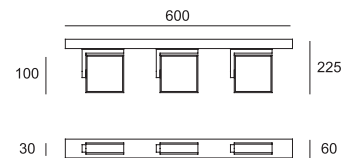

Led CRI >80 IP 40 1140



APPLIQUE/PLAFONE LED ORIENTABILE
Sorgente Led 2x8,7W - 220/240v dimmerabile

Code	Color	Led	Polycarbonate
5621	5 White	1 4000°K 1600 lm 6 2800°K 1300 lm	1 Trasparent 7 Orange 8 Red

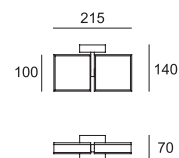

Led CRI >80 CE IP 40 520

APPLIQUE/PLAFONE LED ORIENTABILE
Sorgente Led 2x12W - 220/240v dimmerabile

Code	Color	Led	Polycarbonate
5721	5 White	1 4000°K 2420 lm 6 2800°K 2000 lm	1 Trasparent 7 Orange 8 Red

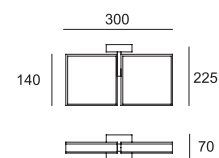

Led CRI >80 CE IP 40 840

BETA

Design Athena

Collezione di faretti, applique e lampada da tavolo a led, realizzate in metallo con faretti orientabili o con flessibile. La nuova tecnologia led per illuminare e valorizzare sia ambienti lavorativi che abitativi.

Collection of metal spotlights, wall lamps and LED table lamps with adjustable spotlights or flexible arms. New LED technology for lighting and enhancing both workplaces and homes.



LAMPADA TAVOLO LED 1x2W 220/240V - FLEX MM 500

Code	Color	Led
8530	1  Chrome	1  4000/4500°K 150 lm
	2  Nikel	6  3000/3200°K 150 lm

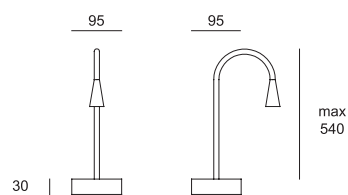



APPLIQUE LED 1x2W 220/240V - FLEX MM 350

Code	Color	Led
8501	1 Chrome	1 4000/4500°K 150 lm
	2 Nikel	6 3000/3200°K 150 lm

APPLIQUE LED 1x2W 220/240V - FLEX MM 500

Code	Color	Led
8511	1 Chrome	1 4000/4500°K 150 lm
	2 Nikel	6 3000/3200°K 150 lm

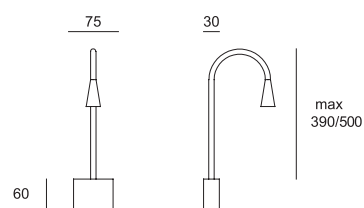

CE IP 40 **8501** **8511**
340 370

FARETTO LED 1x2W 220/240V

Code	Color	Led
8301	1 Chrome	1 4000/4500°K 150 lm
	2 Nikel	6 3000/3200°K 150 lm

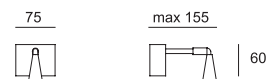

CE IP 40 **8301**
250

ARTE

Design Athena

Applique realizzata in metallo nelle versioni bianco e grigio con la nuova tecnologia led e con la possibilità di orientare le luci. Adatte all'illuminazione di quadri e specchi o come applique in ambienti lavorativi e abitativi.

Wall lamps available with new LED technology and the possibility to adjust the direction of light. Suitable for lighting pictures and mirrors or for use as wall lamps in workplaces and homes.



APPLIQUE LED 9,6W 220/240V

Code	Color	Led
8730	5 White	1 4000°K 800 lm
	7 Grey	6 3000°K 770 lm

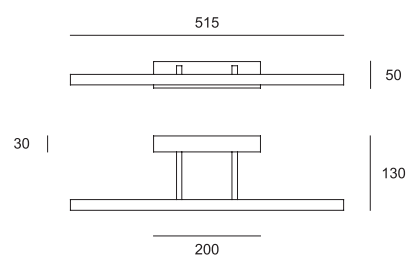

A richiesta misure personalizzate/Custom measurements on demand

Led CRI >90 A CE IP 40 GR 1000

FARETTI

Design Athena



FARETTO SPOT E27 240V

Code	Color	Lamp
7201	1 <input type="checkbox"/> Chrome 5 <input type="checkbox"/> White	E27 LED

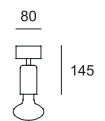

CE IP 20   



FARETTO JARIS GU10 220/240V

Code	Color	Lamp
4101	1 <input type="checkbox"/> Chrome 5 <input type="checkbox"/> White	GU10 LED

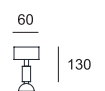

CE IP 20   



BARRA SPOT 2XE27 220/240V

Code	Color	Lamp
477282	1 Chrome 5 White	2xE27 LED

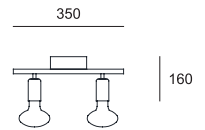

CE IP 20

BARRA SPOT 3XE27 220/240V

Code	Color	Lamp
477283	1 Chrome 5 White	3xE27 LED

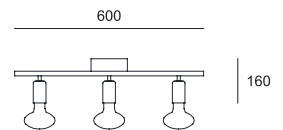

CE IP 20

BARRA SPOT 4XE27 220/240V

Code	Color	Lamp
477284	1 Chrome 5 White	4xE27 LED

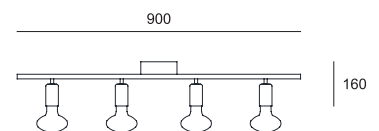

CE IP 20



BARRA JARIS 2XGU10 220/240V

Code	Color	Lamp
474182	1 Chrome 5 White	2xGU10 LED

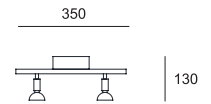

BARRA JARIS 3XGU10 220/240V

Code	Color	Lamp
474183	1 Chrome 5 White	3xGU10 LED

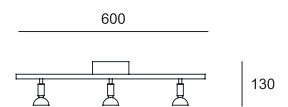

BARRA JARIS 4XGU10 220/240V

Code	Color	Lamp
474184	1 Chrome 5 White	4xGU10 LED

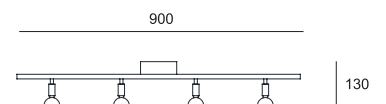

INCASSO

ORIONE
PEGASO

incasso



ORIONE

Design Athena

Faretto da incasso fisso per interno con corpo in ottone. Completo di molle per installazione.

Indoor fixed recessed metal spot light. Copper structure. Springs included.

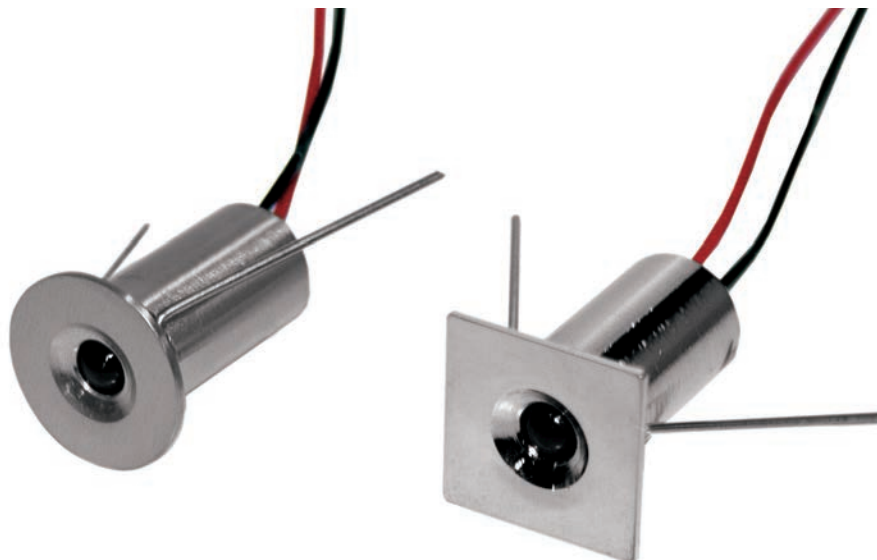

Collegamento in parallelo.

Parallel connection.

FARETTO INCASSO TONDO LED 1x0,5W - 24Vdc 20mA

Code	Color	Led	Optic
11301	1 Chrome 2 Nickel 5 White	1 Natural White 6 Warm White 2 Blue 4 Green 8 Red 9 RGB	120°

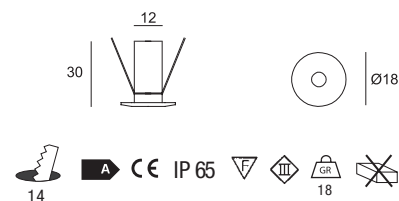

FARETTO INCASSO QUADRO LED 1x0,5W - 24Vdc 20mA

Code	Color	Led	Optic
11311	1 Chrome 2 Nickel 5 White	1 Natural White 6 Warm White 2 Blue 4 Green 8 Red 9 RGB	120°

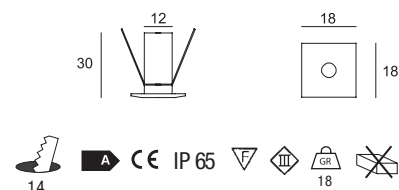

DRIVERS

Utilizzare alimentatori 24Vdc pag 244

Use DRIVERS 24Vdc page 244

ACCESSORI

1130

Cassaforma + OR

Mould + OR

4 Ø 16x35



Faretto ad incasso fisso per interno/esterno, completo di molle per controsoffitto e cavo FROR cm.50.
Corpo in alluminio anodizzato, ghiera in ottone o acciaio AISI 316. Vetro temprato satinato. Calpestabile.

Indoor/outdoor fixed recessed spot light. Ceiling springs and wire FROR cm 50 included. Aluminium structure, copper or Steel AISI 316 front piece.
Tempered satin glass. Walkable.



Collegamento in serie.
Serial connection.

Se interrati, prevedere un drenaggio con ghiaia di circa 20/30 cm.
Utilizzare esclusivamente cavi ed accessori con grado di protezione per uso esterno.
If underground, provide a drainage with gravel 20/30 cm height use only outdoor protection wires accessories.

FARETTO INCASSO TONDO LED 1x1W - 350mA 100 lm

Code	Color	Led	Optic
11302	1 Chrome	1 4000/4500°K	3 120° satinato
	2 Nickel (uso interno)	6 3000/3200°K	
11342	6 Steel		



FARETTO INCASSO QUADRO LED 1x1W - 350mA 100 lm

Code	Color	Led	Optic
11312	1 Chrome	1 4000/4500°K	3 120° satinato
	2 Nickel (uso interno)	6 3000/3200°K	
11352	6 Steel		



DRIVERS

Utilizzare alimentatori 350mA pag 244
Use DRIVERS 350mA page 244

ACCESSORI

1140

Ghiera
Ferrule



1131

Cassaforma + OR
Mould + OR



Ø 62x95

Faretto ad incasso fisso per interno/esterno, completo di molle per controsoffitto e cavo FROR cm.50.
Corpo in alluminio anodizzato, ghiera in ottone o acciaio AISI 316. Vetro temprato satinato. Calpestabile.

Indoor/outdoor fixed recessed spot light. Ceiling springs and wire FROR cm 50 included. Aluminium structure, copper or Steel AISI 316 front piece.
Tempered satin glass. Walkable.



Collegamento in serie.
Serial connection.

Se interrati, prevedere un drenaggio con ghiaia di circa 20/30 cm.
Utilizzare esclusivamente cavi ed accessori con grado di protezione per uso esterno.
If underground, provide a drainage with gravel 20/30 cm height. Use only outdoor protection wires accessories.

FARETTO INCASSO TONDO LED 1x1W - 350mA 100 lm
1x2W - 500mA 150 lm

Code	Color	Led	Optic
11303	1 Chrome	1 4000/4500°K	1 25° trasparente
	2 Nickel (uso interno)	6 3000/3200°K	2 40° trasparente
11343	6 Steel		3 120° satinato

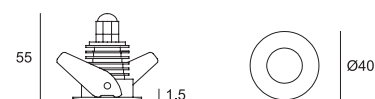

FARETTO INCASSO QUADRO LED 1x1W - 350mA 100 lm
1x2W - 500mA 150 lm

Code	Color	Led	Optic
11313	1 Chrome	1 4000/4500°K	1 25° trasparente
	2 Nickel (uso interno)	6 3000/3200°K	2 40° trasparente
11353	6 Steel		3 120° satinato

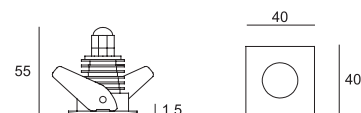

DRIVERS

Utilizzare alimentatori 350-500mA pag 244
Use DRIVERS 350-500mA page 244

ACCESSORI

1132
Cassaforma + OR
Mould + OR

 Ø 62x95
4



Faretto ad incasso fisso per interno/esterno, completo di molle per controsoffitto e cavo FROR cm.50.
Corpo in alluminio anodizzato, ghiera in ottone o acciaio AISI 316. Vetro temprato satinato. Calpestabile.

Indoor/outdoor fixed recessed spot light. Ceiling springs and wire FROR cm 50 included. Aluminium structure, copper or Steel AISI 316 front piece.
Tempered satin glass. Walkable.



Collegamento in serie.
Serial connection.

Se interrati, prevedere un drenaggio con ghiaia di circa 20/30 cm.
Utilizzare esclusivamente cavi ed accessori con grado di protezione per uso esterno.
If underground, provide a drainage with gravel 20/30 cm height use only outdoor protection wires accessories.

FARETTO INCASSO TONDO LED 1x1W - 350mA 100 lm 1x2W - 500mA 150 lm 1x3W - 750mA 200 lm

Code	Color	Led	Optic
11304	1 Chrome	1 4000/4500°K	1 25° trasparente
	2 Nickel (uso interno)	5 5000/5500°K	2 40° trasparente
11344	6 Steel	6 3000/3200°K	3 120° satinato
		9 RGB 3W 350 mA	

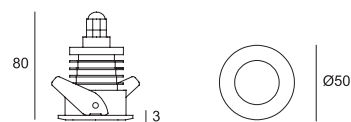

FARETTO INCASSO TONDO LED 1x4,5W - 240mA

Code	Color	Led	Optic
11324	1 Chrome	1 4000°K 400 lm	3 120° satinato
	2 Nickel (uso interno)	6 3000°K 360 lm	

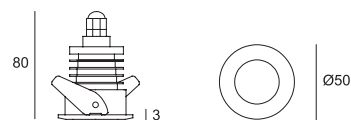

DRIVERS

Utilizzare alimentatori 350-500-700mA pag 244
Use DRIVERS 350-500-700mA page 244

ACCESSORI

1133
Cassaforma + OR
Mould + OR

 Ø 62x95



Faretto ad incasso fisso per interno/esterno, completo di molle per controsoffitto e cavo FROR cm.50.
Corpo in alluminio anodizzato, ghiera in ottone o acciaio AISI 316. Vetro temprato satinato. Calpestabile.

Indoor/outdoor fixed recessed spot light. Ceiling springs and wire FROR cm 50 included. Aluminium structure, copper or Steel AISI 316 front piece.
Tempered satin glass. Walkable.



Collegamento in serie.
Serial connection.

Se interrati, prevedere un drenaggio con ghiaia di circa 20/30 cm.
Utilizzare esclusivamente cavi ed accessori con grado di protezione per uso esterno.
If underground, provide a drainage with gravel 20/30 cm height. Use only outdoor protection wires accessories.

FARETTO INCASSO QUADRO LED **1x1W - 350mA 100 lm**
1x2W - 500mA 150 lm
1x3W - 700mA 200 lm

Code	Color	Led	Optic
11314	1 Chrome	1 4000/4500°K	1 25° trasparente
	2 Nickel (uso interno)	5 5000/5500°K	2 40° trasparente
11354	6 Steel	6 3000/3200°K	3 120° satinato
		9 RGB 3W 350 mA	

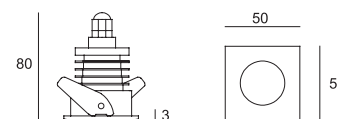

FARETTO INCASSO QUADRO LED **1x4,5W - 240mA**

Code	Color	Led	Optic
11334	1 Chrome	1 4000°K 400 lm	3 120° satinato
	2 Nickel (uso interno)	6 3000°K 360 lm	

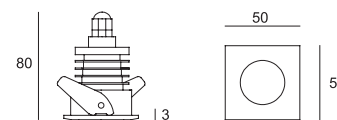

DRIVERS

Utilizzare alimentatori 350-500-700mA pag 244
Use DRIVERS 350-500-700mA page 244

ACCESSORI

1133
Cassaforma + OR
Mould + OR

Ø 62x95





Faretti da incasso fissi per interni a led da 2,6W in metallo. Applicazione con molle per mensole, pensili e controsoffitti.
 Indoor fixed recessed LED spotlight. Application with springs for shelves and wall cabinets.



Collegamento in serie.
 Serial connection.

FARETTO INCASSO 1x2,6W - 140 mA

Code	Color	Led	Optic
11462	1 Chrome	1 4000°K - 235 lm	3 120° satinato
	3 Gold	6 3000°K - 210 lm	
	5 White		
	9 Black		

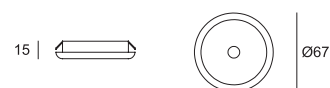

DRIVERS

Utilizzare alimentatori 140mA pag 244
 Use DRIVERS 140mA page 244

Faretto orientabile da incasso. Corpo faretto in ottone. Ghiera in metallo. Applicazione con molle per controsoffitto.
Adjustable recessed spotlight. Copper structure, metal front piece. Application with springs for false ceiling.



Collegamento in serie.
Serial connection.

FARETTO INCASSO TONDO 1x6,6W - 350 mA

Code	Color	Led	Optic
11401	1 Chrome	1 4000°K 650 lm	1 18°
	2 Nickel	6 3000°K 600 lm	2 38°
	5 Matt White		3 54°
	9 Black		

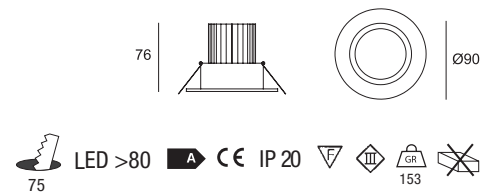

FARETTO INCASSO TONDO 1x9,8W - 350 mA

Code	Color	Led	Optic
11402	1 Chrome	1 4000°K 940 lm	1 18°
	2 Nickel	6 3000°K 850 lm	2 38°
	5 Matt White	9 RGB 11,5W H81	3 54°
	9 Black	3 LED 45°	

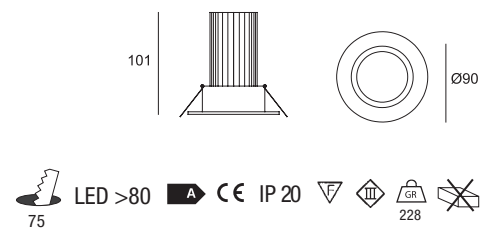

DRIVERS

Utilizzare alimentatori 350mA pag 244
Use DRIVERS 350mA page 244

Faretto orientabile da incasso in metallo. Corpo faretto in ottone, ghiera in metallo. Applicazione con molle per controsoffitto.
Adjustable recessed metal spotlight. Copper structure, metal front piece. Application with springs for false ceiling.



Collegamento in serie.
Serial connection.

FARETTO INCASSO TONDO 1x6,6W - 350 mA

Code	Color	Led	Optic
11411	1 Chrome	1 4000°K - 650 lm	1 18°
	2 Nickel	6 3000°K - 600 lm	2 38°
	5 Matt White		3 54° vetro satinato
	9 Black		

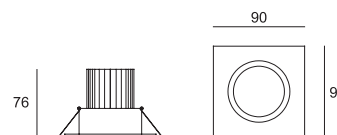

FARETTO INCASSO TONDO 1x9,8W - 350 mA

Code	Color	Led	Optic
11412	1 Chrome	1 4000°K - 940 lm	1 18°
	2 Nickel	6 3000°K - 850 lm	2 38°
	5 Matt White	9 RGB 11,5W H81	3 54°
	9 Black	3 LED 45°	

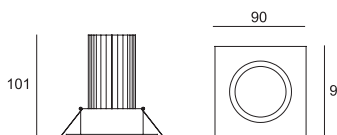

DRIVERS

Utilizzare alimentatori 350mA pag 244
Use DRIVERS 350mA page 244

Faretto fisso da incasso. Corpo faretto in ottone. Ghiera in metallo. Applicazione con molle per controsoffitto.
Fixed recessed spotlight. Copper structure, metal front piece. Application with springs for false ceiling.



Collegamento in serie.
Serial connection.

FARETTO INCASSO TONDO 1x6,6W - 350 mA

Code	Color	Led	Optic
11421	1 Chrome	1 4000°K - 650 lm	1 18°
	2 Nickel	6 3000°K - 600 lm	2 38°
	5 Matt White		3 54°
	9 Black		

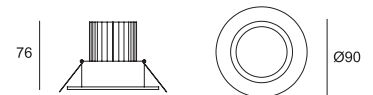

FARETTO INCASSO TONDO 1x9,8W - 350 mA

Code	Color	Led	Optic
11422	1 Chrome	1 4000°K - 940 lm	1 18°
	2 Nickel	6 3000°K - 850 lm	2 38°
	5 Matt White	9 RGB 11,5W H81	3 54°
	9 Black	3 LED 45°	

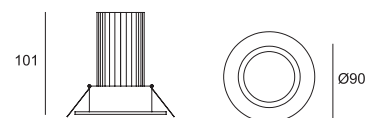

DRIVERS

Utilizzare alimentatori 350mA pag 244
Use DRIVERS 350mA page 244

Faretto fisso da incasso in metallo. Corpo faretto in ottone, ghiera in metallo. Applicazione con molle per controsoffitto.
 Fixed recessed metal spotlight. Copper structure, metal front piece. Application with springs for false ceiling.



Collegamento in serie.
 Serial connection.

FARETTO INCASSO TONDO 1x6,6W - 350 mA

Code	Color	Led	Optic
11431	1 Chrome	1 4000°K - 650 lm	1 18°
	2 Nickel	6 3000°K - 600 lm	2 38°
	5 Matt White		3 54°
	9 Black		

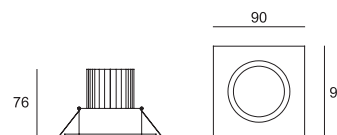

LED >80
 A
 CE
 IP 20

 GR 132

FARETTO INCASSO TONDO 1x9,8W - 350 mA

Code	Color	Led	Optic
11432	1 Chrome	1 4000°K - 940 lm	1 18°
	2 Nickel	6 3000°K - 850 lm	2 38°
	5 Matt White	9 RGB 11,5W H81	3 54°
	9 Black	3 LED 45°	

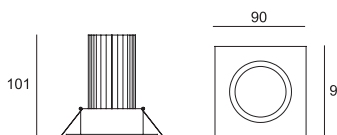

LED >80
 A
 CE
 IP 20

 GR 207

DRIVERS

Utilizzare alimentatori 350mA pag 244
 Use DRIVERS 350mA page 244

Faretto fisso da incasso in metallo. Applicazione con molle per controsoffitto.
Fixed recessed metal spotlight. Application with springs for false ceiling.

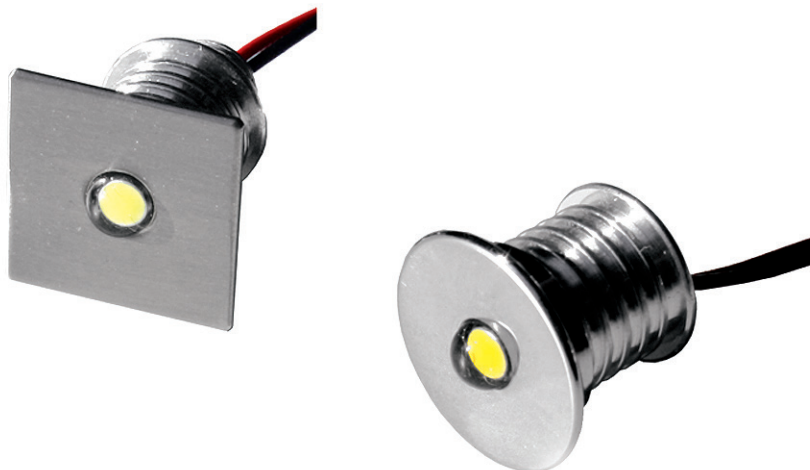

Collegamento in serie.
Serial connection.

FARETTO INCASSO TONDO 1x1W - 350 mA

Code	Color	Led	Optic
11481	1 Chrome	1 4000/4500°K 135lm	1 180°
	2 Nickel	2 Blue	
	5 Matt White	5 5000/7000°K 155lm	
		6 2700/3500°K 145lm	
		8 Red	



FARETTO INCASSO QUADRATO 1x1W - 350 mA

Code	Color	Led	Optic
11491	1 Chrome	1 4000/4500°K 135lm	1 180°
	2 Nickel	2 Blue	
	5 Matt White	5 5000/7000°K 155lm	
		6 2700/3500°K 145lm	
		8 Red	

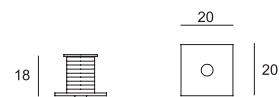

DRIVERS

Utilizzare alimentatori 350mA pag 244
Use DRIVERS 350mA page 244

ACCESSORI

1150
Accessorio per fissaggio spot su spessori fino a 5 mm
Fitting to fix spot on max 5 mm thickness



PEGASO

Design Athena

Faretto incasso orientabile. Corpo in metallo.
Adjustable recessed metal downlight.



FARETTO 90 TONDO ORIENTABILE 220/240V GU10 Led Ø50

Code	Color
1008	1 Chrome
	2 Nickel
	5 Matt White
	9 Black

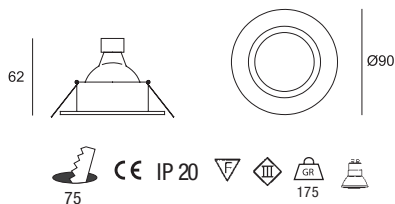

FARETTO 90 QUADRATO ORIENTABILE 220/240V GU10 Led Ø50

Code	Color
1038	1 Chrome
	2 Nickel
	5 Matt White
	9 Black

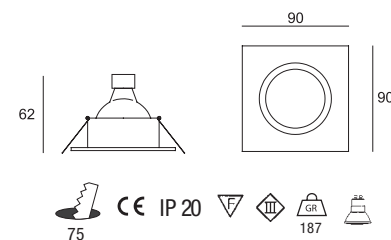

Faretto incasso fisso. Corpo in metallo.
Fixed recessed metal spot light.



FARETTO 80 TONDO FISSO
220/240V GU10 Led Ø50

Code	Color
1010	1 Chrome
	2 Nickel
	5 Matt White
	9 Black

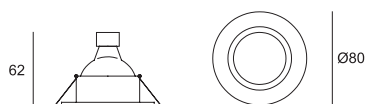

FARETTO 80 QUADRATO FISSO
220/240V GU10 Led Ø50

Code	Color
1040	1 Chrome
	2 Nickel
	5 Matt White
	9 Black

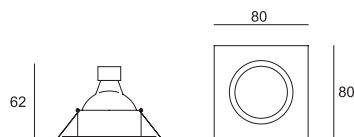

Faretto incasso orientabile. Corpo in metallo.
Adjustable recessed metal downlight.



FARETTO 70 TONDO ORIENTABILE
220/240V GU10 Led Ø35

Code	Color
1011	1 Chrome
	2 Nickel
	5 Matt White
	9 Black

FARETTO 70 QUADRATO ORIENTABILE
220/240V GU10 Led Ø35

Code	Color
1041	1 Chrome
	2 Nickel
	5 Matt White
	9 Black

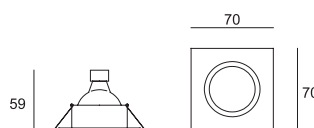

ACCESSORI

DRIVERS
CENTRALINE
LAMPADINE

Accessori

























DRIVERS

Design Athena

DRIVERS CLASSE II

Alimentatori elettronici per power led 140-240-350-500-700 mA - Collegamento in serie.

Electronic DRIVERS for power led 140-240-350-500-700 mA - Serial connection.

	1261	OUTPUT 140mA 45V max 6W	118x33x19	CE IP 20   
	1263	OUTPUT 240mA 45V max 10W	118x33x19	CE IP 20   
	1170	OUTPUT 350mA 45V max 15W	117x50x28	CE IP 20   
	1179 Multipower	OUTPUT 350mA 10/45V max 16W OUTPUT 500mA 10/45V max 22W OUTPUT 700mA 10/45V max 32W	130x45x30	CE IP 20   
	1172	OUTPUT 500mA 24V max 10W	70x42x20	CE IP 20   
	1251	OUTPUT 700mA 12V max 8,4W	72x41x14	CE IP 20   

Alimentatori elettronici per power led DIMMERABILI con push 350-500-700 mA - Collegamento led in serie.

Dimmable electronic DRIVERS for power led 350-500-700 mA - Serial Connection.

	1177 Multipower 1..10v & PUSH	OUTPUT 350mA 43V max 15W OUTPUT 500mA 43V max 22W OUTPUT 700mA 36V max 25W	103x67x22	CE IP 20    foro Ø 70
11749 Cavetto di sincronizzazione per 1177 - lunghezza mm1500 Synchronization cable for 1177- Length mm 1500				
	1178 Multipower 1..10v & PUSH	OUTPUT 350mA 43V max 15W OUTPUT 500mA 36V max 20W OUTPUT 700mA 29V max 20W	111x52x22	CE IP 20    foro Ø 55
Sincronizzazione automatica con push - max 4 pezzi Automatic synchro with push - max 4 pieces				

Alimentatori elettronici per power led 350-700 mA - Collegamento in serie - IP67- Collegamento led in serie.





































Electronic DRIVERS for power led 350-700 mA - Serial connection - IP67.

	1258	OUTPUT 350mA 48V min 3W max 15W	140x30x22	CE IP 20   
	1259	OUTPUT 700mA 25V min 7W max 15W	140x30x22	CE IP 20   

DRIVERS 24VDC CLASSE II

Alimentatori elettronici per led 24Vdc - Collegamento led in parallelo.

Electronic DRIVERS for led 24 Vdc - Parallel connection.

	1172	max 10W	VOLT DC24		70x42x20	CE IP 20				45
	1183	max 20W	VOLT DC24		136x55x19	CE IP 20				130
	1195	max 30W	VOLT DC24		165x41x28	CE IP 20				166
						foro Ø 48				
	1184	max 75W	VOLT DC24		225x60x36	CE IP 20				290
	1201	max 75W slim	VOLT DC24		305x30x17	CE IP 20				152
	1182	max 100W	VOLT DC24		207x76x35	CE IP 20				300
	1202	max 100W slim	VOLT DC24		312x30x18	CE IP 20				152
	1185	max 150W	VOLT DC24		207x76x35	CE IP 20				300
	1181	max 150W slim	VOLT DC24		330x33x23	CE IP 20				255

DRIVERS DIMMERABILI 24VDC CLASSE II CON PUSH

Alimentatori elettronici dimmerabili per power led 24Vdc - Collegamento led in parallelo.

Electronic DRIVERS dimmable for led 24 Vdc - Parallel connection.

































	1178	1..10v & PUSH max 20W	VOLT DC24		111x52x22	CE IP 20				108
				Sincronizzazione automatica con push - max 4 pezzi Automatic synchro with push - max 4 pieces		foro Ø 55				
	1186	1..10v & PUSH (per potenziometro 470K) max 60W	VOLT DC24		206x51x37	CE IP 20				250
		NO MEMORIA								
	1196	1..10v & PUSH max 100W	VOLT DC24		240x61x49	CE IP 20				250
	11969	Cavetto di sincronizzazione per 1196 - Lunghezza mm 1500 Synchronization cable for 1196 - length mm 1500								

Per la scelta degli alimentatori, dopo aver calcolato l'assorbimento totale degli apparecchi da installare, aggiungere circa il 10/15 % di margine in più.
For the choice of DRIVERS, after calculating the total absorption of the equipment to install, add about 10/15 % power more.

DRIVERS 24VDC CON CONTENITORE

Contenitori in metallo completi di alimentatori elettronici per Led 24Vdc - Collegamento led in parallelo.



Metal boxex with electronic DRIVERS for 24Vdc led. Parallel led connection.

	1187 5 White 1187 7 Grey 1187 9 Black	max 20W max 20W max 20W	VOLT DC24 VOLT DC24 VOLT DC24	200x70x35	CE IP 20  
	1197 5 White 1197 7 Grey 1197 9 Black	max 30W max 30W max 30W	VOLT DC24 VOLT DC24 VOLT DC24	200x70x35	CE IP 20  
	1188 5 White 1188 7 Grey 1188 9 Black	max 75W max 75W max 75W	VOLT DC24 VOLT DC24 VOLT DC24	260x80x45	CE IP 20  
	1199 5 White 1199 7 Grey 1199 9 Black	max 75W max75W max75W	VOLT DC24 VOLT DC24 VOLT DC24	130x130x41	CE IP 20   
	1256 5 White 1256 7 Grey 1256 9 Black	max 100W max 100W max 100W	VOLT DC24 VOLT DC24 VOLT DC24	142x182x41	CE IP 20   
	1257 5 White 1257 7 Grey 1257 9 Black	max 150W max 150W max 150W	VOLT DC24 VOLT DC24 VOLT DC24	142x182x41	CE IP 20   
	1270 5 White 1270 7 Grey 1270 9 Black	max 200W max 200W max 200W	VOLT DC24 VOLT DC24 VOLT DC24	262x162x50	CE IP 20   
	1271 5 White 1271 7 Grey 1271 9 Black	max 2x100W max 2x100W max 2x100W	VOLT DC24 VOLT DC24 VOLT DC24	262x162x50	CE IP 20   
	1272 5 White 1272 7 Grey 1272 9 Black	max 2x150W max 2x150W max 2x150W	VOLT DC24 VOLT DC24 VOLT DC24	262x162x50	CE IP 20   

DRIVERS 24VDC

Alimentatori elettronici in metallo 24Vdc per Led. Collegamento led in parallelo.

Electronic metal DRIVERS 24Vdc. Parallel Led connection.

	1252	max 35W	VOLT DC24 Installare in adeguati contenitori - Install in appropriate cases	100x82x30	CE IP 20	 
	1189	max 50W	VOLT DC24 Installare in adeguati contenitori - Install in appropriate cases	100x82x30	CE IP 20	 
	1190	max 75W	VOLT DC24 Installare in adeguati contenitori - Install in appropriate cases	100x97x30	CE IP 20	 
	1191	max 100W	VOLT DC24 Installare in adeguati contenitori - Install in appropriate cases	129x97x30	CE IP 20	 
	1192	max 150W	VOLT DC24 Installare in adeguati contenitori - Install in appropriate cases	159x97x30	CE IP 20	 
	1198	max 200W	VOLT DC24 Installare in adeguati contenitori - Install in appropriate cases	215x115x50	CE IP 20	 
	1193	max 240W	VOLT DC24 Installare in adeguati contenitori - Install in appropriate cases Raffreddamento a ventola - Fan cooling system Potrebbe dare un leggero ronzio - Could be slightly noisy	190x100x50	CE IP 20	 
	1194	max 320W	VOLT DC24 Installare in adeguati contenitori - Install in appropriate cases Raffreddamento a ventola - Fan cooling system Potrebbe dare un leggero ronzio - Could be slightly noisy	215x115x50	CE IP 20	 

DRIVERS 24VDC IP67

Alimentatori elettronici per led supplies 24Vdc - Collegamento led in parallelo.

Electronic DRIVERS for led supplies 24 Vdc - Parallel LED connection.

	1240	max 20W	VOLT DC24	118x35x26	CE IP 67	 
	1241	max 35W	VOLT DC24	148x40x30	CE IP 67	 
	1242	max 60W	VOLT DC24	163x43x32	CE IP 67	 
	1243	max 100W	VOLT DC24	190x52x37	CE IP 67	 
	1245	max 150W	VOLT DC24	190x52x37	CE IP 67	 

Per la scelta degli alimentatori, dopo aver calcolato l'assorbimento totale degli apparecchi da installare, aggiungere circa il 10/15 % di margine in più.
For the choice of DRIVERS, after calculating the total absorption of the equipment to install, add about 10/15 % power more.

CENTRALINE ON/OFF DIMMER PER ALIMENTATORI 24 VDC

Centralina elettronica ON/OFF DIMMER per led 24Vdc da utilizzare con alimentatori 24Vdc.







Electronic control unit ON/OFF DIMMER for led 24Vdc to be used with 24Vdc power supply units.

	1260	Centralina ON/OFF DIMMER 24Vdc 3 canali 3,3A-80W per canale MAX 240W Gestione DALI/PUSH (0-10V,1-10V)	138x40x29	CE IP 20   130
	1226	Centralina ON/OFF DIMMER 24Vdc 3 canali 3,3A-80W per canale MAX 240W Con telecomando radio frequenza	138x40x29	CE IP 20   188
	1262	Amplificatore segnale 24Vdc per 1260 e 1226 3 canali 3,3A-80W per canale MAX 240W	138x40x29	CE IP 20   130
	1300	Centralina ON/OFF DIMMER 24Vdc MAX 240W MASTER/SLAVE PUSH 0-10v 1-10v	56x68x35	CE IP 20   40
	1303	Centralina ON/OFF DIMMER 24Vdc MAX 240W CASAMBI - PUSH	56x68x35	CE IP 20   40
	1304	Centralina ON/OFF DIMMER 24Vdc MAX 240W DALI PUSH 0-10v 1-10v	56x68x35	CE IP 20   40

CENTRALINE PER RGB RGB/WHITE

Centralina elettronica **EXTRACEE** RGB per led 24Vdc da utilizzare con alimentatori 24Vdc - gestita con telecomando.

EXTRACEE electronic DRIVERS unit RGB for led 24Vdc. Use with DRIVERS 24 Vdc - Remote controlled.

	1227	Centralina controllo led RBG - RGB/W 24Vdc 4 canali 3A-72W per canale MAX 288W Con telecomando radio frequenza	75x65x20	CE IP 20   135
	1267	Amplificatore segnale RBG - RGB/W 24Vdc 4 canali 3A-72W per canale MAX 288W	150x75x35	CE IP 20   250

CENTRALINE PER GESTIONE DYNAMIC WHITE

Centralina elettronica DYNAMIC White (variazione da warm White a cold White) per led 24Vdc da utilizzare con alimentatori 24Vdc - Gestita con telecomando.









Electronic control unit DYNAMIC White (from warm White to cold White) for led 24Vdc to be used with 24Vdc power supply units - Remote controlled.

	1230	Centralina controllo led DYNAMIC White 24Vdc 2 canali 5A-120W per canale MAX 240W Con telecomando radio frequenza	50x30x23	CE IP 20   90
---	-------------	--	----------	--

CENTRALINE PER RGB

Centralina elettronica RGB per led 24Vdc da utilizzare con alimentatori 24Vdc - gestita con telecomando o push.

Electronic control unit RGB for led 24Vdc to be used with 24Vdc power supply units. Remote or push controlled.

	1225	Centralina controllo led RGB 24Vdc 3 canali 3,3A-80W per canale MAX 240W Con telecomando radio frequenza	138x40x29	CE IP 20  	186
	1262	Amplificatore segnale RGB per 1225 3 canali 3,3A-80W per canale MAX 240W	138x40x29	CE IP 20  	130
	1305	Centralina controllo Led RGB 24Vdc MAX 150W Gestione PUSH	56x68x35	CE IP 20  	40

ALIMENTATORI/CENTRALINE PER RGB

Centralina elettronica RGB **completa di alimentatore** max 120W per led 24Vdc - gestita con push.

Electronic DRIVERS/control unit for led RGB 24Vdc - max 120W. Push controlled.

	1196	Alimentatore centralina controllo led RGB 24Vdc MASTER/SLAVE 24Vdc MAX 120W Vdc 3 canali 1,65A-40W per canale MAX 120W Con 1 o più pulsanti (non compresi)	240x61x49	CE IP 20   	250
		Ingresso DMX con funzione auto-test incorporato e led di spegnimento. Uscite 3x12/24 V PW/M Input DMX with integrated auto-test function and switching off led. Output 3x12/24 V PW/M			
	11969	Cavetto di sincronizzazione per 1196 - Lunghezza mm 1500 Synchronization cable for 1196 - length mm 1500			

Centralina elettronica RGB - RGB/White **completa di alimentatore** max 96W per power led 24Vdc - gestita con Dmx - Dali - Push



Electronic DRIVERS/control unit for RGB - RGB/White 24Vdc - max 96w. Dmx - Dali - Push controlled.

	1228	Alimentatore centralina controllo led RGB - RGB/White 24Vdc RGB 3 canali 1,38A-33W per canale MAX 96W RGB/W 4 canali 1,04A-24W per canale MAX 96W	207x76x35	CE IP 20   	300
				foro Ø 80	

CENTRALINE PER RGB PER POWER LED 350mA

Centralina elettronica RGB per power led 350mA da utilizzare con alimentatori 24Vdc.

Electronic RGB control unit for power led 350mA. Use with DRIVERS 24Vdc.

	N° LED 6x3Canali	V IN DC24	I OUT DC350mA	15538x20	CE IP 20  	110
	1219	Centralina elettronica MASTER RGB power led 350mA 2 tritici full colour. Con telecomando e ricevitore.				
	1220	Centralina elettronica SLAVE RGB power led 350mA. 2 tritici full colour. Max 10 slave. Con cavetto sincronizzatore mm2000.				
		Uscita in corrente costante Output in direct current				

CONVERTITORE

Convertitore led da 24Vdc a 350mA da utilizzare con alimentatore tensione costante 24Vdc e/o centraline RGB.
Power LED converter from 24Vdc to 350mA. Use with DRIVERS 24Vdc and/or RGB control unit.

**1218**

Input 24 Vdc output 350mA
2 trittici (6 led) Full colour RGB 350 mA
6 trittici (18 led) Monocromatici RGB 350 mA

50x40x24

CE IP 20   74**CENTRALINE PER RGB IN DMX512**

Centralina elettronica RGB per led 24Vdc in Dmx 512 da utilizzare con alimentatori 24Vdc.
Electronic RGB control unit for led 24Vdc in DMX 512. Use with DRIVERS 24Vdc.

**1215**

Centralina controllo led RGB 24Vdc
DMX512 master 24VDC 4A per canale **MAX 280W**
Con telecomando radio frequenza

142x85x38

CE IP 20   182**1216**

Centralina controllo led RGB 24Vdc
DMX512 slave 24VDC 4A per canale **MAX 280W**
Con cavetto di sincronizzazione cm 90.
Funzionamento con protocollo DMX512
o su richiesta con pulsante (non fornito).

142x85x38

CE IP 20   175**UNITÀ EMERGENZA**

Unità di emergenza (1 h) da utilizzare con alimentatori adeguati.
Emergency unit (1h). Use with appropriate DRIVERS.

**1250**

N° LED 6 Vf 3,7 Posizione switch B
N° LED 12 Vf 3,7 Posizione switch C
N° LED 18 Vf 3,2 Posizione switch D
24Vdc 30W Posizione switch B

batteria 125x45x23
emergenza 155x51x26

CE IP 20   430**DIMMER ELETTRONICO 230V****1310**







Dimmer elettronico 230V
230V 105W 50Hz

43x41x21

CE IP 20   20

LAMPADINE LED

LED bulbs

	<u>Codice</u>	<u>Codice</u>	<u>Codice</u>
	1  Natural White 4000°K 600lm		6  Warm White 3000°K 540lm
 Lampadina 1x6,6w 350mA H65 18°	296002006001A		296002006001G
Lampadina 1x6,6w 350mA H65 38°	296002006002A		296002006002G
Lampadina 1x6,6w 350mA H65 54°	296002006003A		296002006003G
<hr/>			
	1  Natural White 4000°K 810lm		6  Warm White 3000°K 740lm
 Lampadina 1x9,8w 350mA H95 18°	296002007001A		296002007001G
Lampadina 1x9,8w 350mA H95 38°	296002007002A		296002007002G
Lampadina 1x9,8w 350mA H95 54°	296002007003A		296002007003G

CAVI

Cables

<u>Cavi</u>	<u>Sezione</u>	<u>Misure</u>	<u>Temperatura di impiego</u>	<u>Codice</u>
PVC+FEP Trasparente Polarizzati riga bianca, rossa, nera	4x0,50	mm 4,8 Ø	T180/105°	205007000048
PVC+FEP Trasparente Polarizzati riga bianca	2xAVG22	mm 3,6 Ø	T180/105°	205007000045
Unipolare FEP-rosso	AVG22		T180°	205007000046
Unipolare FEP-nero	AVG22		T180°	205007000047
PVC Flat quadripolare RGB	AVG22	mm 5,4 x 1,4	T90°	205007000050
Cavo FROR grigio 2x0,75	AVG22		T180°	205003000020
Cavo SEZ 4x0,50 x LED RGB grigio			T180°	205003000023
Cavo SEZ 6x0,35 x LED RGB grigio			T180°	205003000024

INDICE E CODICI

Design Athena

0200	Focus300-160	pag. 100-108	0472	Focus160	pag. 106	11431	Orione	pag. 237
0202	Focus300-160	pag. 100-108	0490	Focus160	pag. 105	11432	Orione	pag. 237
0203	Focus300-160-Twin	pag. 100-108-130	0631	Twin	pag. 127	11462	Orione	pag. 233
0204	Focus300-160	pag. 100-108	0635	Twin	pag. 128	11481	Orione	pag. 238
0205	Focus300-160	pag. 100-108	0639	Twin	pag. 129	11491	Orione	pag. 238
0206	Focus300-160	pag. 100-108	0640	Twin	pag. 129	1150	Orione	pag. 238
0207	Focus300-160	pag. 100-108	0644	Twin	pag. 128	1170	Alimentatori	pag. 244
0208	Focus300-160-Twin	pag. 100-108-130	0646	Twin	pag. 128	1172	Alimentatori	pag. 244-245
0209	Focus300-160	pag. 100-108	0647	Twin	pag. 127	11749	Alimentatori	pag. 244
0210	Focus300-160	pag. 101-109	0648	Twin	pag. 127	1175	Alimentatori	pag. 244
0211	Focus300	pag. 99	0649	Twin	pag. 129	1177	Alimentatori	pag. 244
0214	Focus300-160	pag. 101-108	1008	Pegaso	pag. 239	1178	Alimentatori	pag. 244-245
0234	Focus300	pag. 98	1010	Pegaso	pag. 240	1179	Alimentatori	pag. 244
0240	Focus300	pag. 95	1011	Pegaso	pag. 241	1181	Alimentatori	pag. 245
0243	Focus300	pag. 96	1038	Pegaso	pag. 239	1182	Alimentatori	pag. 245
0251	Focus300	pag. 98	1040	Pegaso	pag. 240	1183	Alimentatori	pag. 245
0272	Focus300	pag. 97	1041	Pegaso	pag. 241	1184	Alimentatori	pag. 245
0282	Focus300	pag. 97	1130	Orione	pag. 227	1185	Alimentatori	pag. 245
0289	Focus300	pag. 91	11301	Orione	pag. 227	1186	Alimentatori	pag. 245
0290	Focus300	pag. 93	11302	Orione	pag. 228	1187	Alimentatori	pag. 246
0319	Twin	pag. 130	11303	Orione	pag. 229	1188	Alimentatori	pag. 246
0328	Twin	pag. 130	11304	Orione	pag. 230	1189	Alimentatori	pag. 247
0329	Twin	pag. 130	1131	Orione	pag. 228	1190	Alimentatori	pag. 247
0330	Twin	pag. 130	11311	Orione	pag. 227	1191	Alimentatori	pag. 247
0331	Twin	pag. 130	11312	Orione	pag. 228	1192	Alimentatori	pag. 247
0335	Twin	pag. 130	11313	Orione	pag. 229	1193	Alimentatori	pag. 247
0336	Twin	pag. 130	11314	Orione	pag. 231	1194	Alimentatori	pag. 247
0338	Twin	pag. 131	1132	Orione	pag. 229	1195	Alimentatori	pag. 245
0339	Twin	pag. 131	11324	Orione	pag. 230	1196	Alimentatori	pag. 245-249
0340	Twin	pag. 131	1133	Orione	pag. 231	11969	Alimentatori	pag. 245-249
0341	Twin	pag. 131	11334	Orione	pag. 231	1197	Alimentatori	pag. 246
0353	Twin	pag. 118	11342	Orione	pag. 228	1198	Alimentatori	pag. 247
0354	Twin	pag. 121	11343	Orione	pag. 229	1199	Alimentatori	pag. 246
0355	Twin	pag. 119	11344	Orione	pag. 230	1201	Alimentatori	pag. 245
0357	Twin	pag. 111	11352	Orione	pag. 228	1202	Alimentatori	pag. 245
0358	Twin	pag. 113	11353	Orione	pag. 229	1215	Alimentatori	pag. 250
0360	Twin	pag. 114	11354	Orione	pag. 231	1216	Alimentatori	pag. 250
0361	Twin	pag. 115	1140	Orione	pag. 228	1218	Alimentatori	pag. 250
0362	Twin	pag. 115	11401	Orione	pag. 234	1219	Alimentatori	pag. 249
0363	Twin	pag. 117	11402	Orione	pag. 234	1220	Alimentatori	pag. 249
0434	Focus160	pag. 107	11411	Orione	pag. 235	1225	Alimentatori	pag. 249
0435	Focus160	pag. 107	11412	Orione	pag. 235	1226	Alimentatori	pag. 248
0457	Focus160	pag. 103	11421	Orione	pag. 236	1227	Alimentatori	pag. 248
0458	Focus160	pag. 104	11422	Orione	pag. 236	1228	Alimentatori	pag. 249

1230	Alimentatori	pag. 248	4101	Faretti	pag. 221	59221	Incrocio	pag. 158
1240	Alimentatori	pag. 247	474182	Faretti	pag. 223	59222	Incrocio	pag. 156
1241	Alimentatori	pag. 247	474183	Faretti	pag. 223	59223	Incrocio	pag. 158
1242	Alimentatori	pag. 247	474184	Faretti	pag. 223	59224	Incrocio	pag. 156
1243	Alimentatori	pag. 247	477282	Faretti	pag. 222	59225	Incrocio	pag. 158
1245	Alimentatori	pag. 247	477283	Faretti	pag. 222	59226	Incrocio	pag. 156
1250	Alimentatori	pag. 250	477284	Faretti	pag. 222	59227	Incrocio	pag. 160
1251	Alimentatori	pag. 244	5221	Dadajè	pag. 172	7003	Edera	pag. 170
1252	Alimentatori	pag. 247	5261	Dadajè	pag. 174	7201	Faretti	pag. 221
1256	Alimentatori	pag. 246	5262	Dadajè	pag. 175	763130	Edera	pag. 165
1257	Alimentatori	pag. 246	5263	Dadajè	pag. 175	763160	Edera	pag. 165
1258	Alimentatori	pag. 244	5271	Dadajè	pag. 177	763530	Edera	pag. 166
1259	Alimentatori	pag. 244	5272	Dadajè	pag. 177	763560	Edera	pag. 166
1260	Alimentatori	pag. 248	5282	Dadajè	pag. 178	763930	Edera	pag. 168
1261	Alimentatori	pag. 244	5291	Dadajè	pag. 176	763960	Edera	pag. 168
1262	Alimentatori	pag. 248-249	5321	Dadajè	pag. 172	764030	Edera	pag. 168
1263	Alimentatori	pag. 244	5391	Dadajè	pag. 176	764060	Edera	pag. 168
1267	Alimentatori	pag. 248	5401	Dadajè	pag. 178	764430	Edera	pag. 166
1270	Alimentatori	pag. 246	5601	Milo	pag. 215	764460	Edera	pag. 166
1271	Alimentatori	pag. 246	5621	Milo	pag. 217	764630	Edera	pag. 166
1272	Alimentatori	pag. 246	5622	Milo	pag. 216	764660	Edera	pag. 166
1280	Edera - Giotto	pag. 170-183	5623	Milo	pag. 216	764730	Edera	pag. 165
1281	Edera	pag. 170	5701	Milo	pag. 215	764760	Edera	pag. 165
1282	Edera - Giotto	pag. 170-188	5721	Milo	pag. 217	764830	Edera	pag. 165
1283	Edera	pag. 170	5831	Riflessi	pag. 211	764860	Edera	pag. 165
1284	Edera	pag. 170	5832	Riflessi	pag. 211	764930	Edera	pag. 168
1285	Giotto	pag. 183	5833	Riflessi	pag. 211	764960	Edera	pag. 168
1285D	Giotto	pag. 183	5834	Riflessi	pag. 211	772119	Giotto	pag. 188
1286	Giotto	pag. 188	5844	Kite	pag. 213	772219	Giotto	pag. 188
1286D	Giotto	pag. 188	5854	Kite	pag. 213	772319	Giotto	pag. 188
1287	Edera	pag. 170	59121	Incrocio	pag. 158	772419	Giotto	pag. 188
1288	Edera	pag. 170	59122	Incrocio	pag. 156	775119	Giotto	pag. 181
1289	Twin	pag. 132	59123	Incrocio	pag. 158	775219	Giotto	pag. 181
1290	Twin	pag. 132	59124	Incrocio	pag. 156	775319	Giotto	pag. 181
1291	Twin	pag. 132	59125	Incrocio	pag. 158	775419	Giotto	pag. 181
1292	Twin	pag. 132	59126	Incrocio	pag. 156	775519	Giotto	pag. 181
1300	Alimentatori	pag. 248	59127	Incrocio	pag. 160	775619	Giotto	pag. 181
1303	Alimentatori	pag. 248	59128	Incrocio	pag. 160	775719	Giotto	pag. 181
1304	Alimentatori	pag. 248	59151	Incrocio	pag. 162	776019	Giotto	pag. 184
1305	Alimentatori	pag. 249	59152	Incrocio	pag. 162	776119	Giotto	pag. 184
1310	Alimentatori	pag. 250	59153	Incrocio	pag. 163	776219	Giotto	pag. 187
1410	Twin	pag. 125	59154	Incrocio	pag. 163	802120	Bridge	pag. 137
3110	Twin	pag. 122	59161	Incrocio	pag. 154	802220	Bridge	pag. 137
3310	Twin	pag. 123	59162	Incrocio	pag. 154	802320	Bridge	pag. 137

802420	Bridge	pag. 137	9049	Sigma	pag. 32	93724	Sihon Move	pag. 56
802520	Bridge	pag. 139	9050	Sigma	pag. 32	93819	Sihon Touch	pag. 56
802620	Bridge	pag. 139	9051	Sigma	pag. 32-35	93824	Sihon Touch	pag. 56
802720	Bridge	pag. 139	905119	Degas	pag. 191	9399	Sihon	pag. 58
802820	Bridge	pag. 139	9052	Sigma	pag. 32-35	9451	Kappa	pag. 70
812120	Swing	pag. 141	905219	Degas	pag. 192	9452	Kappa	pag. 70
812320	Swing	pag. 141	905319	Degas	pag. 192	9453	Micro	pag. 67
8301	Beta	pag. 219	905419	Degas	pag. 191	9454	Micro	pag. 67
8501	Beta	pag. 219	905519	Degas	pag. 193	9455	Vela	pag. 69
8511	Beta	pag. 219	905619	Degas	pag. 195	9456	B-Light	pag. 62
8530	Beta	pag. 218	908019	Degas	pag. 196	9491	Piatto	pag. 71
8661	Modi	pag. 145	908119	Degas	pag. 196	9492	Piatto	pag. 71
8662	Libro	pag. 142	908219	Degas	pag. 199	9493	B-Light	pag. 62
8680	Modi	pag. 145	908619	Degas	pag. 199	9494	Vela	pag. 68
8730	Arte	pag. 220	9099	Sigma	pag. 30	9495	Micro	pag. 66
88611	Picasso	pag. 207	9119	Tau Led	pag. 49	949519	Micro	pag. 65
88612	Picasso	pag. 207	9121	Tau Led	pag. 49	949521	Micro	pag. 65
88621	Picasso	pag. 208	9124	Tau Led	pag. 49	949524	Micro	pag. 65
88622	Picasso	pag. 208	9151	Tau	pag. 53	9499	Kappa	pag. 70
88631	Picasso	pag. 208	9152	Tau	pag. 53	95505	Omega Wet	pag. 37
88632	Picasso	pag. 208	91710	Tau Move	pag. 50	95510	Omega Wet	pag. 37
8944	Monet	pag. 201	91724	Tau Move	pag. 50	9551	Omega	pag. 40
8945	Monet	pag. 201	91824	Tau Touch	pag. 50	9552	Omega	pag. 40
8946	Monet	pag. 201	91819	Tau Touch	pag. 50	95524	Omega Wet	pag. 37
8947	Monet	pag. 201	9199	Tau	pag. 52	9555	Omega	pag. 40
8954	Monet	pag. 202	9205	Etha	pag. 76	9599	Omega	pag. 40
8955	Monet	pag. 202	9210	Etha	pag. 76	95605	Omega Wet	pag. 39
8956	Monet	pag. 204	9298	Etha	pag. 76	95610	Omega Wet	pag. 39
8957	Monet	pag. 204	9299	Etha	pag. 76	95624	Omega Wet	pag. 39
8974	Monet	pag. 202	930549	Sihon	pag. 55	96405	Delta Led resinato	pag. 73
8975	Monet	pag. 202	930550	Sihon	pag. 55	96410	Delta Led resinato	pag. 73
8976	Monet	pag. 204	930599	Sihon	pag. 61	96424	Delta Led resinato	pag. 73
8977	Monet	pag. 204	9319	Sihon Led	pag. 55	9619	Delta Led	pag. 43
9019	Sigma Led1	pag. 27	9321	Sihon Led	pag. 55	9621	Delta Led	pag. 43
9021	Sigma Led1	pag. 27	9324	Sihon Led	pag. 55	9624	Delta Led	pag. 43
90221	Sigma Led2	pag. 28	9349	Sihon	pag. 59	9649	Delta	pag. 46
90224	Sigma Led2	pag. 28	9350	Sihon	pag. 59	9650	Delta	pag. 47
90219	Sigma Led2	pag. 28	9352	Sihon	pag. 59	9651	Delta	pag. 46
9024	Sigma Led1	pag. 27	9353	Sihon	pag. 60	9652	Delta	pag. 46
90349	Sigma3	pag. 35	9354	Sihon	pag. 60	9653	Sigma-Delta- Tau-Sihon-Vela	pag. 32-35 pag. 53-59-69
90350	Sigma3	pag. 35	93405	Sihon Led resinato	pag. 74	9654	Sigma-Delta- Sihon	pag. 32-47 pag. 59
90399	Sigma3	pag. 34	93410	Sihon Led resinato	pag. 74	9655	Delta-Sihon	pag. 60
9047	Sigma	pag. 32	93424	Sihon Led resinato	pag. 74			
9048	Sigma	pag. 32	93710	Sihon Move	pag. 56			

9656	Sigma-Delta-	pag. 33-35	98210209	Omicron Tecnico	pag. 13	98610221	Omicron Dec	pag. 151
	Tau-Sihon-Micro	pag. 53-59-67	98210211	Omicron Tecnico	pag. 15	98610222	Omicron Dec	pag. 151
9657	Sigma-Delta-	pag. 32-35	98210212	Omicron Tecnico	pag. 15	98610223	Omicron Dec	pag. 151
	Sihon-Vela	pag. 59-69	98210213	Omicron Tecnico	pag. 16	98610224	Omicron Dec	pag. 152
9658	Sigma-Delta-Sihon	pag. 32-35-59	98210214	Omicron Tecnico	pag. 16	98610225	Omicron Dec	pag. 152
9659	Sigma	pag. 33	98210218	Omicron Tecnico	pag. 16	98611121	Omicron Dec	pag. 151
9660	Sigma-Delta-Tau-	pag. 32-35	98310109	Omicron Tecnico	pag. 13	98611122	Omicron Dec	pag. 151
	Sihon-Kappa-	pag. 59-70	98310111	Omicron Tecnico	pag. 15	98611123	Omicron Dec	pag. 151
	Micro-Vela	pag. 67	98310112	Omicron Tecnico	pag. 15	98611124	Omicron Dec	pag. 152
9661	Sigma-Delta-	pag. 47-33	98310113	Omicron Tecnico	pag. 16	98611125	Omicron Dec	pag. 155
	Tau-Sihon	pag. 53-74	98310114	Omicron Tecnico	pag. 16	98611221	Omicron Dec	pag. 151
9662	Sigma-Delta-	pag. 33-47	98310118	Omicron Tecnico	pag. 16	98611222	Omicron Dec	pag. 151
	Tau-Sihon	pag. 53-59	98310209	Omicron Tecnico	pag. 13	98611223	Omicron Dec	pag. 151
96710	Delta Move	pag. 44	98310211	Omicron Tecnico	pag. 15	98611224	Omicron Dec	pag. 152
96724	Delta Move	pag. 44	98310212	Omicron Tecnico	pag. 15	98611225	Omicron Dec	pag. 152
96819	Delta Touch	pag. 44	98310213	Omicron Tecnico	pag. 16	9862	Omicron Dec	pag. 151
96824	Delta Touch	pag. 44	98310214	Omicron Tecnico	pag. 16	98710109	Omicron Dec	pag. 21
9699	Delta	pag. 46	98310218	Omicron Tecnico	pag. 16	98710111	Omicron Dec	pag. 23
970	Strip Flex	pag. 85	9851	Omicron Tecnico	pag. 22	98710114	Omicron Dec	pag. 23
9710	Strip Flex	pag. 85	98510108	Omicron Dec	pag. 148	98710118	Omicron Dec	pag. 23
9719	Strip Flex	pag. 85	98510109	Omicron Tecnico	pag. 20	98710209	Omicron Dec	pag. 21
9730	Strip Flex	pag. 84	98510111	Omicron Tecnico	pag. 23	98710211	Omicron Dec	pag. 23
9739	Strip Flex	pag. 84	98510114	Omicron Tecnico	pag. 23	98710214	Omicron Dec	pag. 23
9740	Strip Flex	pag. 84	98510118	Omicron Tecnico	pag. 23	98710218	Omicron Dec	pag. 23
9749	Strip Flex	pag. 84	98510208	Omicron Dec	pag. 148	98711109	Omicron Dec	pag. 21
9760	Strip Flex	pag. 79	98510209	Omicron Tecnico	pag. 20	98711209	Omicron Dec	pag. 21
9769	Strip Flex	pag. 79	98510211	Omicron Tecnico	pag. 23	9895	Omicron Tecnico	pag. 22
97803	Strip Flex	pag. 80	98510214	Omicron Tecnico	pag. 23	9897	Omicron Tecnico	pag. 14
97893	Strip Flex	pag. 80	98510218	Omicron Tecnico	pag. 23	9898	Omicron Tecnico	pag. 22
979	Strip Flex	pag. 85	98511108	Omicron Dec	pag. 149	990	Strip Flex	pag. 83
97900	Strip Flex	pag. 80	98511109	Omicron Tecnico	pag. 20	9910	Strip Flex	pag. 83
979020	Strip Flex	pag. 78	98511208	Omicron Dec	pag. 149	9919	Strip Flex	pag. 83
979029	Strip Flex	pag. 78	98511209	Omicron Tecnico	pag. 20	996705	Strip Flex	pag. 87
979060	Strip Flex	pag. 79	9852	Omicron Tecnico	pag. 22	996710	Strip Flex	pag. 87
979069	Strip Flex	pag. 79	9853	Omicron Tecnico	pag. 14	996724	Strip Flex	pag. 86
97990	Strip Flex	pag. 80	9854	Omicron Tecnico	pag. 14	999	Strip Flex	pag. 83
98210108	Omicron Dec	pag. 147	9857	Omicron Tecnico-	pag. 22	999030	Strip Flex	pag. 81
98210208	Omicron Dec	pag. 147		Bridge	pag. 138	999039	Strip Flex	pag. 81
98210109	Omicron Tecnico	pag. 13	9858	Omicron Tecnico	pag. 22	999040	Strip Flex	pag. 81
98210111	Omicron Tecnico	pag. 15	98610121	Omicron Dec	pag. 151	999049	Strip Flex	pag. 81
98210112	Omicron Tecnico	pag. 15	98610122	Omicron Dec	pag. 151	999050	Strip Flex	pag. 82
98210113	Omicron Tecnico	pag. 16	98610123	Omicron Dec	pag. 151			
98210114	Omicron Tecnico	pag. 16	98610124	Omicron Dec	pag. 152			
98210118	Omicron Tecnico	pag. 16	98610125	Omicron Dec	pag. 152			

Condizioni di vendita

I colori delle fotografie degli articoli, i grafici e le quote riportati nel presente catalogo si intendono a titolo indicativo. Athena srl si riserva la facoltà di modificare le caratteristiche tecniche ed estetiche dei prodotti senza alcun preavviso, al fini di apportare migliorie ai propri articoli. Il catalogo è tutelato dalla legge del diritto di autore e pertanto, ne è vietata la riproduzione anche parziale.

Sales Conditions

The colours of the photographs of the articles, the graphs and the amount quoted in this catalogue are only indicative. Athena reserves the right to make any modification to the technical and aesthetic characteristics of the products without any forewarning, in order to improve its articles. The catalogue is protected by the law of copyright and, therefore, it is forbidden to copy it, even partially.



ATHENA
così in luce

Via Varesina, 36 - 22078 Turate (CO)
T +39 02 96480755 - F +39 02 9681981
info@athenainluce.it
amministratore@athenainluce.it
commerciale@athenainluce.it
www.athenainluce.it

www.athenainluce.it



Facebook

