

AMOS BIG

Apparecchio a parete per illuminazione di esterni ad emissione di luce con varie aperture di fasci luminosi costituito da:

- Struttura in alluminio pressofuso verniciato
- Vetri piani temperati e/o lenti
- Parabola riflettente in alluminio
- Guarnizioni in silicone
- Viti di chiusura in acciaio inox
- Verniciatura in polveri poliestere ad elevata resistenza ai raggi ultravioletti e alla corrosione

Wall outdoor luminaire with various light band openings constructed of:

- Painted die-cast aluminium structure
- Tempered glasses or/and lenses
- Aluminium reflector
- Silicon gaskets
- Stainless steel screws
- Painting using high resistance to UV and corrosion polyester powders



Colori - Colours

X=9  Antracite
Anthracite

X=4  Silver

Diffusore - Diffuser

Codice-Code 00 8021
vetro / glass

Codice-Code 04 8022
lente tonda / round lens

Codice-Code 04 8023
lente rettangolare / rectangular lens

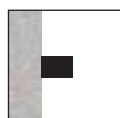

Installazione a parete
Wall mounting

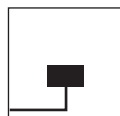

Entrata singola cavi di alimentazione
Single power supply cables input

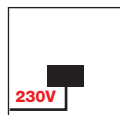

L'apparecchio è fornito completo di alimentatore elettronico 220/240V 50/60Hz posizionato all'interno dell'apparecchio.
The luminaire is supplied with a 220/240V 50/60Hz built-in power supply.

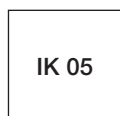

IK 05

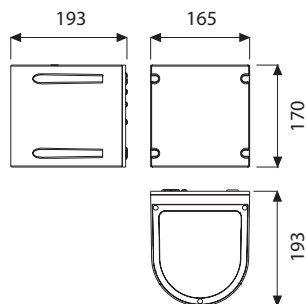

Bidirezionale

Double direction light

8020.55X	LED	2x8W	2x1400 lm	4000 K
8020.56X	LED	2x8W	2x1400 lm	3000 K



8020

Monodirezionale

Mono direction light

8021.00X	LED	12W	E27	
8021.55X	LED	8W	1400 lm	4000 K
8021.56X	LED	8W	1400 lm	3000 K



8021

Bidirezionale con 1 lente e un vetro

Double direction light with 1 lens and 1 glass

8022.55X	LED	2x10W	2x1800 lm	4000 K
8022.56X	LED	2x10W	2x1800 lm	3000 K
8022.35X	 HIT	35W	G12	



8022

Bidirezionale con 1 lente a fascio stretto e un vetro

Double direction light with 1 narrow light beam lens and 1 glass

8023.55X	LED	2x8W	2x1400 lm	4000 K
8023.56X	LED	2x8W	2x1400 lm	3000 K



8023

AMOS MINI

Apparecchio da parete per illuminazione di interni e di esterni ad emissione di luce con varie aperture di fasci luminosi costituito da:

- Struttura in alluminio pressofuso verniciato
- Vetri piani temperati e/o lenti
- Parabola riflettente in alluminio
- Guarnizioni in silicone
- Viti di chiusura in acciaio inox
- Verniciatura in polveri poliestere ad elevata resistenza ai raggi ultravioletti e alla corrosione

Wall outdoor and indoor luminaire with various light beams constructed of:

- Painted die-cast aluminium structure
- Tempered glasses or/and lenses
- Aluminium reflector
- Silicon gaskets
- Stainless steel screws
- Painting using high resistance to UV and corrosion polyester powders



Colori - Colours

X=9  Antracite
Anthracite

X=4  Silver

Diffusore - Diffuser

Codice-Code 00 8091

vetro / glass

Codice-Code 04 8093

lente rettangolare / rectangular lens

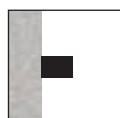

Installazione a parete
Wall mounting

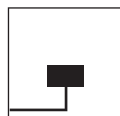

Entrata singola cavi di alimentazione
Single power supply cables input

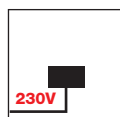

LED
Led a tensione di rete 220/240V 50/60Hz.
Connessione diretta alla rete di alimentazione
senza necessità di alimentatore.
LED's direct operation at 220/240V 50/60Hz.
No power supply is required.



Lampadina LED GU10 IP20 dimmerabile
LED GU10 IP20 dimmable bulb

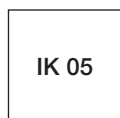

IK 05

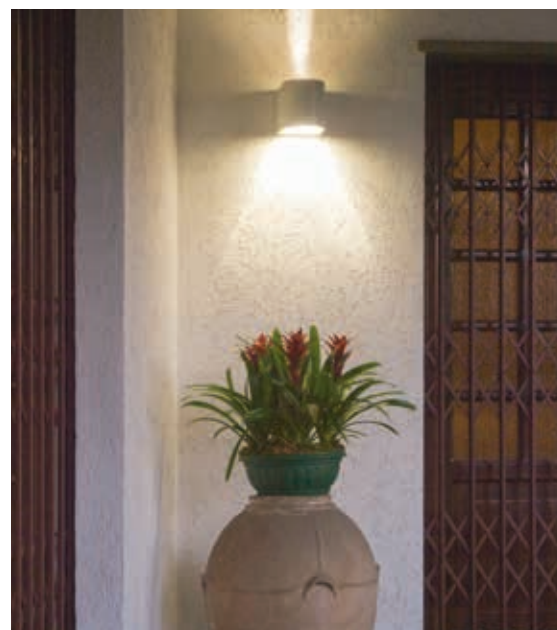

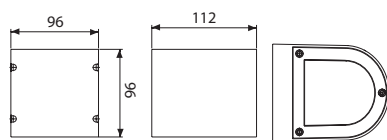

AMOS MINI su richiesta è disponibile anche con fascio luminoso 40°.
 AMOS MINI available also with 40° light beam on request.



8091

Monodirezionale con un vetro - Fascio luminoso $\pm 70^\circ$
 Mono direction light with one glass - $\pm 70^\circ$ light beam

8091.66X	LED	4W	510 lm	4000 K
8091.67X	LED	4W	500 lm	3000 K
• 8091.05X	LED GU10	4,9W	560 lm	4000 K
• 8091.06X	LED GU10	4,9W	560 lm	3000 K



8092

Bidirezionale con due vetri - Fasci luminosi $\pm 70^\circ$
 Double direction light with two glasses - $\pm 70^\circ$ light beams

8092.66X	LED	2x4W	2x510 lm	4000 K
8092.67X	LED	2x4W	2x500 lm	3000 K



8093

Bidirezionale con una lente $\pm 10^\circ$ e un vetro fascio luminoso $\pm 70^\circ$
 Double direction light with 1 lens $\pm 10^\circ$ and 1 glass $\pm 70^\circ$ light beam

8093.66X	LED	2x4W	2x510 lm	4000 K
8093.67X	LED	2x4W	2x500 lm	3000 K

- L'apparecchio viene fornito completo di lampadina
 Bulb enclosed with the luminaire