



# **BOTLIGHTING**

PER UN FUTURO ILLUMINATO.  
LUGLIO **2017**





## LAMPADE A LED

### LAMPADE A LED FULL LIGHT

GOCCIA FULL LIGHT 220-240V	18
SFERA FULL LIGHT 220-240V	18
OLIVA FULL LIGHT 220-240V	19
GLOBO 95 FULL LIGHT 220-240V	19
GLOBO 126 FULL LIGHT 220-240V	19

### LAMPADE A LED STICK

GOCCIA LED STICK 220-240V	21
GOCCIA LED STICK 220-240V DIMMERABILE	21
SFERA LED STICK 220-240V	22
OLIVA LED STICK 220-240V	22
OLIVA LED STICK 220-240V DIMMERABILE	23
TUBOLARE T25 LED STICK 220-240V	23
GLOBO 126 LED STICK 220-240V	23
GLOBO 126 LED STICK 220-240V DIMMERABILE	24
GOCCIA LED STICK CUPOLA ARGENTATA 220-240V	24
SFERA LED STICK CUPOLA ARGENTATA 220-240V	24
GOCCIA LED STICK SATINATA 220-240V	25
SFERA LED STICK SATINATA 220-240V	25
OLIVA LED STICK SATINATA 220-240V	26
OLIVA LED STICK SATINATA 220-240V DIMMERABILE	26
TORTIGLIONE LED STICK SATINATA 220-240V	26
FIAMMA LED STICK SATINATA 220-240V	27
GLOBO 126 LED STICK SATINATA 220-240V	27
REFLECTOR R63 LED STICK SATINATA 220-240V	27
REFLECTOR R80 LED STICK SATINATA 220-240V	28
REFLECTOR R125 LED STICK SATINATA 220-240V	28
GOCCIA LED STICK AMBER 220-240V	30
OLIVA LED STICK AMBER 220-240V	30
GLOBO 95 LED STICK AMBER 220-240V	30
GLOBO 126 LED STICK AMBER 220-240V	31
EDISON ST58 LED STICK AMBER 220-240V	31

### LAMPADE A LED PRO

GOCCIA OPALE 220-240V	32
GOCCIA OPALE 220-240V DIMMERABILE	32
GOCCIA OPALE 220-240V CON SENSORE CREPUSCOLARE	33
GOCCIA OPALE 220-240V CON SENSORE DI MOVIMENTO	33
GOCCIA OPALE 220-240V 3STEP DIMMERABILE	35
GOCCIA OPALE 220-240V 3STEP CCT	35
GOCCIA OPALE 12/24V AC/DC	35
SFERA OPALE 220-240V DIMMERABILE	36
OLIVA OPALE 220-240V DIMMERABILE	36
GLOBO 95 OPALE 220-240V	36
GLOBO 120 OPALE 220-240V	37
PICCOLA PERA PER FRIGORIFERI 220-240V	38
PICCOLA PERA 220-240V	38
PICCOLA PERA COLORATA 220-240V	38
TUBOLARI T37 220-240V	39
TUBOLARI T45 220-240V	39
REFLECTOR R39 220-240V	40

REFLECTOR R50 220-240V	40
REFLECTOR R63 220-240V	40
REFLECTOR R80 220-240V	41
LED GU10 220-240V	42
LED GU10 220-240V DIMMERABILE	42
LED GU10 220-240V	43
LED GU10 220-240V ALL-GLASS	44
LED GU10 220-240V ALL-GLASS DIMMERABILE	44
LED GU10 220-240V	45
LED GU10 220-240V DIMMERABILE	45
LED MR16 AC/DC 12V	46
LED MR11 AC/DC 12V	47
LED G9 220-240V	48
LED BISPINA G4 AC/DC 12V	49
LED BISPINA G4 AC/DC 12V SATINATA	49
LED LINEARI R7S 220-240V	50
LED LINEARI R7S 220-240V DIMMERABILE	50
LT TUBO LED VETRO CON FILM DI PROTEZIONE T8 220-240V	51
LT TUBO LED POLICARBONATO T8 220-240V	51
STARTER PER TUBI A LED	51
PL ALC LED 220-240V	52
LED AR111 AC/DC 12V	52
LED AR111 100-240V	52
LED PAR30 100-240V	53
LED PAR38 100-240V	53
LED PAR38 100-240V WATERPROOF IP65	53
LED LINEARLINE 300MM 220-240V	54
LED LINEARLINE 600MM 220-240V	54
LED LINEARLINE 1000MM 220-240V	54
LED PLANT GOCCIA PER CRESCITA PIANTE 220-240V	55
LED FROST GOCCIA PER CELLA FRIGORIFERA -40 C° 220-240V	55
LED SFERA 220-240V IP54	55

### LAMPADE A LED STD

GOCCIA OPALE 220-240V	56
SFERA OPALE 220-240V	57
OLIVA OPALE 220-240V	58

## LAMPADE ALOGENE

GOCCIA CHIARA ENERGY SAVING 230V DIMMERABILE	62
SFERA CHIARA ENERGY SAVING 230V DIMMERABILE	62
OLIVA CHIARA ENERGY SAVING 230V DIMMERABILE	63
FIAMMA CHIARA ENERGY SAVING 12V DIMMERABILE	63
TORTIGLIONE CHIARA ENERGY SAVING 230V DIMMERABILE	63
GLOBO D126 CHIARA ENERGY SAVING 230V DIMMERABILE	64
HALONINE CHIARA ENERGY SAVING 230V DIMMERABILE	64
BISPINA CHIARA ENERGY SAVING 12V DIMMERABILE	64
LINEARI ENERGY SAVING 230V DIMMERABILE	65
TUBOLARI ENERGY SAVING 230V DIMMERABILE	65
TUBOLARE ENERGY SAVING 230V DIMMERABILE	66
DICROICA CON VETRO ENERGY SAVING 12V DIMMERABILE	66
DICROICA MR11 ENERGY SAVING 12V DIMMERABILE	66
LINEARI 230V DIMMERABILE	67
BISPINA CHIARA 12V DIMMERABILE	67

## LAMPADE A INCANDESCENZA

GOCCIA CHIARA 24V	70
PICCOLA PERA CHIARA 230V	70
PICCOLA PERA CHIARA PER FORNI 300° 230V	70
PICCOLA PERA CHIARA PER FRIGORIFERI 240V	71
GOCCIA PESCA 27V	71
SPOT RAGGI INFRAROSSI 230V	71

## LAMPADE FLUORESCENTI LINEARI E CIRCOLARI

TRIFOSFORDO ALTA EFFICIENZA LUMINOSA T5 Ø 16 MM 230V	74
TRIFOSFORDO ALTA EMISSIONE LUMINOSA T5 Ø 16MM 230V	75
TRIFOSFORDO SHORT T5 Ø 16MM 220V	75
TRIFOSFORDO T8 Ø 26MM 220V	76
CIRCOLARI TRIFOSFORDO T9 230V	76
CIRCOLARI T5 230V	77

## LAMPADE FLUORESCENTI COMPATTE E COMPATTE NON INTEGRATE

AL LONGLIFE 230V	80
ALC LONGLIFE 230V	80
ALL LONGLIFE 230V	81
ALDE LONGLIFE 230V	81
ALSE LONGLIFE 230V	82
ALTE LONGLIFE 230V	82
2C LONGLIFE 230V	83

## LAMPADE A SCARICA

NCK-G CERAMIC 230V	86
NCK-TC CERAMIC 230V	86
NACHROMA DOPPIO ATTACCO 230V	87
NACHROMA ELLISSOIDALE DIFFONDENTE 230V	88
NATRALOX SUPER TUBOLARE TRASPARENTE 230V	88

## APPARECCHI A LED INDOOR E OUTDOOR

### APPARECCHI A LED INDOOR

PANNELLO A LED ALTA EFFICIENZA 220-240V	92
PANNELLO A LED ALTA EFFICIENZA 220-240V	93
PANNELLO A LED ALTA EFFICIENZA UGR-19 220-240V	94
KIT SOSPENSIONE	94
LED DRIVER PER PANNELLO A LED 220-240V	94
KIT MONTAGGIO A SOFFITTO	94
KIT MONTAGGIO A SOFFITTO UNIVERSALE	95
KIT EMERGENZA 220-240V	95
DOWNLIGHT 220-240V DIMMERABILE Ø 170	98

DOWNLIGHT 220-240V DIMMERABILE Ø 220	99
MODULO A LED CRI >90 220-240V DIMMERABILE	100
ANELLI DI FISSAGGIO ORIENTABILI CIRCOLARI	100
ANELLI DI FISSAGGIO ORIENTABILI QUADRATI	100
ANELLO DI FISSAGGIO FISSO PER AMBIENTI UMIDI CON VETRO IP65	100
PROIETTORE PER BINARIO CENTER 220-240V BIANCO	102
PROIETTORE PER BINARIO CENTER 220-240V NERO	103
SISTEMA MODULARE DI BARRE A LED T5 220-240V	104
SHOT S-FLAT LED 230V	106
SISTEMA DI ILLUMINAZIONE A STRIP LED 12V	110
SISTEMA DI ILLUMINAZIONE A STRIP LED 24V	110
MODULO LED CIRCOLARE MAGNETICO 200-240V	112
MODULO LED CIRCOLARE MAGNETICO 200-240V	113
PLAFONIERA COCO 220-240V	114
PLAFONIERA RIO 220-240V	116
PLAFONIERA RIO RADAR 220-240V	117
PLAFONIERA SONO III PIR 220-240V	118
PLAFONIERA PRIMO 220-240V	119
<b>APPARECCHI A LED OUTDOOR</b>	
PLAFONIERA AMBRA CIRCOLARE 220-240V	120
PLAFONIERA AMBRA QUADRATA 220-240V	121
PLAFONIERA AMBRA RETTANGOLARE 220-240V	122
APPLIQUE NASBY LED DOPPIO FASCIO REGOLABILE 220-240V	123
APPLIQUE SUND SINGOLO/DOPPIO FASCIO BIANCO	124
APPLIQUE SUND SINGOLO/DOPPIO FASCIO ANTRACITE	125
APPLIQUE GETA LED QUATTRO FASCI BIANCA	126
APPLIQUE GETA LED QUATTRO FASCI ANTRACITE	127
HOLM SEGNAPASSO	128
GARDA LAMPADE DA GIARDINO	130
STONE PIETRA DA GIARDINO	132
DENVER 10/20/30/50BW PROIETTORE A LED SLIM BIANCO LUCIDO	134
DENVER 10/20/30/50N PROIETTORE A LED SLIM NERO SATINATO	136
DENVER 20/30N PROIETTORE A LED SLIM CON SENSORE MOV.	138
MIAMI 10/20/30BW PROIETTORE A LED SLIM BIANCO 100-240V	140
MIAMI 10/20/30N PROIETTORE A LED SLIM NERO 100-240V	140
MIAMI 20N MW CON SENSORE DI MOVIMENTO A LED SLIM 100-240V	141
DALLAS SMALL 30/50BW PROIETTORE A LED BIANCO PROFESSIONAL	142
DALLAS SMALL 30/50N PROIETTORE A LED NERO PROFESSIONAL	143
DALLAS BIG 100/150/200N PROIETTORE A LED NERO PROFESSIONAL	144
NEW YORK 40/80G PROIETTORE A LED ANTRACITE PROFESSIONAL	146
TOKYO 150/200N PROIETTORE A LED NERO PROFESSIONAL	147
AKRON 20N 12/24V AC/DC	148
STAND PER PROIETTORE	148
PLAFONIERA STAGNA LED	149
SCHERMO RICAMBIO	149
HIGHBAY A LED	150
STAFFA OPZIONALE PER HIGHBAY	150
DIFFUSORE OPZIONALE PER HIGHBAY 60°/90°	150

## APPARECCHI A LED LUCE NOTTURNA E PORTATILI

LUCE NOTTURNA POWER LED 230V	154
LUCE NOTTURNA POWER LED CREPUSCOLARE 230V	154

LUCE NOTTURNA POWER LED CREPUSCOLARE CON SENSORE DI MOVIMENTO 230V	154
LUCE NOTTURNA POWER LED CREPUSCOLARE 230V	155
LUCE NOTTURNA NEVADA POWER LED CON PRESE USB 230V	155
LUCE NOTTURNA DOVER POWER LED CON PRESE USB 230V	155
LAMPADA DA ARMADIO CABINET CON SENSORE DI MOVIMENTO	156
LED BICYCLE FRONT LIGHT	156
LED BICYCLE FRONT LIGHT POWER LED	156
LED BICYCLE FRONT LIGHT CON CARICA USB	157
LED BICYCLE FRONT LIGHT SMALL	157
LED BICYCLE BACK LIGHT SMALL	157
LED BICYCLE REAR RED LIGHT	158
LED DUO MULTI POWER-LED	158
FASCIA RUNNING RED	159
FASCIA RUNNING WHITE	159
FLASHLIGHT TORCIA PORTATILE A LED RICARICABILE	159
AIRAM HEADLIGHT	160
AIRAM POWER HEADLIGHT	160
LANTERNA DA CAMPEGGIO	160
LANTERNA DA CAMPEGGIO CON RICARICA USB	161
MEGA700 TORCIA LED FLASHLIGHT 700LM	161
MEGA800 TORCIA LED FLASHLIGHT 800LM CON RICARICA USB	161
GUMLIGHT HI-POWER	162
EXPO TORCE LED COLORI VARI 12 PEZZI	162
EXPO TORCE IN GOMMA COLORI VARI 12 PEZZI	162
EXPO WORKLIGHT LED COLORI VARI 9 PEZZI	163
PORTACHIAVI LED	163
PEN LED LIGHT	163

## ACCESSORI PER LAMPADE

STARTER NORMALI	166
ALIMENTATORI ELETTRONICI PER LAMPADE FLUORESCENTI T8	166
ALIMENTATORI ELETTRONICI PER LAMPADE FLUORESCENTI T5	167
ACCENDITORI UNIVERSALI PER LAMPADE A SCARICA	167

## PILE ELETTRICHE

EVOLUTION + ALKALINE	170
SUPER ALKALINE MULTIPACK	170
ALKALINE	171
LITHIUM	171

GLOSSARIO	172
-----------	-----

TIPI DI ATTACCO	174
-----------------	-----

CONDIZIONI GENERALI DI VENDITA	175
--------------------------------	-----

## LAMPADE A LED FULL LIGHT



GOCCIA FULL LIGHT P. 18



SFERA FULL LIGHT P. 18



SFERA FULL LIGHT P. 18



OLIVA FULL LIGHT P. 19



GLOBO 95 FULL LIGHT P. 19



GLOBO 126 FULL LIGHT P. 19

## LAMPADE A LED STICK



GOCCIA LED STICK P. 21



GOCCIA LED STICK P. 21



SFERA LED STICK P. 22



SFERA LED STICK P. 22



OLIVA LED STICK P. 22



OLIVA LED STICK P. 23



TUBOLARE T25 LED STICK  
P. 23



GLOBO 126 LED STICK P. 23



GLOBO 126 LED STICK P. 24



GOCCIA LED STICK CUPOLA  
ARGENTATA P. 24



SFERA LED STICK CUPOLA  
ARGENTATA P. 24



GOCCIA LED STICK SATINATA  
P. 25



SFERA LED STICK SATINATA  
P. 25



SFERA LED STICK SATINATA  
P. 25



OLIVA LED STICK SATINATA  
P. 26



OLIVA LED STICK SATINATA  
P. 26



TORTIGLIONE LED STICK  
SATINATA P. 27



FIAMMA LED STICK  
SATINATA P. 27



GLOBO 126 LED STICK  
SATINATA P. 27



REFLECTOR R63 LED STICK  
SATINATA P. 27



REFLECTOR R80 LED STICK  
SATINATA P. 28



REFLECTOR R125 LED STICK  
SATINATA P. 28



GOCCIA LED STICK AMBER  
P. 30



OLIVA LED STICK AMBER  
P. 30



GLOBO 95 LED STICK AMBER  
P. 30



GLOBO 126 LED STICK  
AMBER P. 31



EDISON ST58 LED STICK  
AMBER P. 31

## LAMPADE A LED PRO



GOCCIA OPALE P. 32



GOCCIA OPALE P. 32



GOCCIA OPALE CON SENSORE  
CREPUSCOLARE P. 33



GOCCIA OPALE CON SENSORE  
DI MOVIMENTO P. 33



GOCCIA OPALE 3STEP  
DIMMERABILE P. 35



GOCCIA OPALE 3STEP CCT  
P. 35



GOCCIA OPALE 12/24V  
AC/DC P. 35



SFERA OPALE P. 36



OLIVA OPALE P. 36



GLOBO 95 OPALE P. 36



GLOBO 120 OPALE P. 37



PICCOLA PERA  
PER FRIGORIFERI P. 38



PICCOLA PERA P. 38



PICCOLA PERA COLORATA  
P. 38



TUBOLARI T37 P. 39



TUBOLARI T45 P. 39



REFLECTOR R39 P. 40



REFLECTOR R50 P. 40



REFLECTOR R63 P. 40



REFLECTOR R80 P. 41



LED GU10 P. 42/43



LED GU10 P. 42



LED GU10 ALL-GLASS P. 44



LED GU10 ALL-GLASS P. 44



LED GU10 P. 45



LED GU10 P. 45



LED MR16 P. 46



LED MR16 P. 46



LED MR11 P. 47



LED MR11 P. 47



LED G9 P. 48



LED G9 P. 48



LED G9 P. 48



LED BISPINA G4 P. 49



LED BISPINA G4 P. 49



LED BISPINA G4 SATINATA P. 49



LED LINEARI R7S P. 50



LED LINEARI R7S P. 50



LT TUBO LED VETRO CON FILM DI PROTEZIONE T8 P. 51



LT TUBO LED POLICARBONATO T8 P. 51



STARTER PER TUBI A LED P. 51



PL ALC LED P. 52



LED AR111 G53 P. 52



LED AR111 GU10 P. 52



LED PAR30 P. 53



LED PAR38 P. 53



LED PAR38 WATERPROOF IP65 P. 53



LED LINEARLINE 300MM P. 54



LED LINEARLINE 600MM P. 54



LED LINEARLINE 900MM P. 54



LED PLANT GOCCIA PER CRESCITA PIANTE P. 55



LED FROST GOCCIA PER CELLA FRIGORIFERA P. 55



LED SFERA IP54 P. 55

## LAMPADE A LED STD



GOCCIA OPALE P. 56



SFERA OPALE P. 57



OLIVA OPALE P. 57



OLIVA OPALE P. 58

## LAMPADE ALOGENE



GOCCIA CHIARA ENERGY SAVING P. 62



SFERA CHIARA ENERGY SAVING P. 62



OLIVA CHIARA ENERGY SAVING P. 63



FIAMMA CHIARA ENERGY SAVING P. 63



TORTIGLIONE CHIARA ENERGY SAVING P. 63



GLOBO D126 CHIARA ENERGY SAVING P. 64



HALONINE CHIARA ENERGY SAVING P. 64



BISPINA CHIARA ENERGY SAVING P. 64



LINEARI ENERGY SAVING P. 65



TUBOLARI ENERGY SAVING P. 65



TUBOLARE ENERGY SAVING P. 66



DICROICA CON VETRO ENERGY SAVING P. 66



DICROICA MR 11 ENERGY SAVING P. 66



LINEARI P. 67



BISPINA CHIARA P. 67

## LAMPADE A INCANDESCENZA



GOCCIA CHIARA P. 70



PICCOLA PERA CHIARA P. 70



PICCOLA PERA CHIARA PER FORNI 300° P. 70



PICCOLA PERA CHIARA PER FRIGORIFERI P. 71



GOCCIA PESCA P. 71



SPOT RAGGI INFRAROSSI P. 71

## LAMPADE FLUORESCENTI LINEARI E CIRCOLARI



TRIFOSFORO ALTA EFFICIENZA LUMINOSA P. 74



TRIFOSFORO T5 P. 75



TRIFOSFORO SHORT P. 75



TRIFOSFORO T8 P. 76



CIRCOLARI T9 P. 76



CIRCOLARI T5 P. 77

## LAMPADE FLUORESCENTI COMPATTE NON INTEGRATE



AL LONGLIFE P. 80



ALC LONGLIFE P. 80



ALL LONGLIFE P. 81



ALDE LONGLIFE P. 81



ALSE LONGLIFE P. 82



ALTE LONGLIFE P. 82



2C LONGLIFE P. 83

## LAMPADE A SCARICA



NCK-G CERAMIC P. 86



NCK-TG CERAMIC P. 86



NACHROMA DOPPIO ATTACCO P. 87



NACHROMA ELLISSOIDALE DIFFONDEnte P. 88



NATRALOX SUPER TUBOLARE TRASPARENTE P. 88

## APPARECCHI A LED INDOOR



PANNELLO A LED ALTA EFFICIENZA P. 92-93



PANNELLO A LED ALTA EFFICIENZA UGR<19 P. 94



KIT MONTAGGIO SOSPENSIONE P. 94



KIT MONTAGGIO A SOFFITTO P. 94



KIT MONTAGGIO A SOFFITTO UNIVERSALE P. 95



KIT EMERGENZA P. 95



DOWNLIGHT DIM. P. 98-99



MODULO LED CRI>90 DIM. P. 100



ANELLI DI FISSAGGIO P. 100



PROIETTORE PER BINARIO CENTER BIANCO P. 102



PROIETTORE PER BINARIO CENTER NERO P. 103

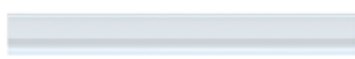

SISTEMA MODULARE E ACCESSORI P. 104



SHOT S-FLAT P. 106



SISTEMA DI ILLUMINAZIONE A STRIP LED P. 110



MODULO LED CIRCOLARE MAGNETICO P. 112



MODULO LED CIRCOLARE MAGNETICO P. 113



PLAFONIERA COCO P. 114



PLAFONIERA RIO P. 116



PLAFONIERA RIO RADAR P. 117





PLAFONIERA SONO III PIR P. 118



PLAFONIERA PRIMO P. 119

## APPARECCHI A LED OUTDOOR



PLAFONIERA AMBRA CIRCOLARE P. 120



PLAFONIERA AMBRA QUADRATA P. 121



PLAFONIERA AMBRA RETTANGOLARE P. 122



APPLIQUE NASBY LED DOPPIO FASCIO REGOLABILE P. 123



APPLIQUE SUND SINGOLO/DOPPIO FASCIO BIANCO P. 124



APPLIQUE SUND SINGOLO/DOPPIO FASCIO ANTRACITE P. 125



APPLIQUE GETA LED QUATTRO FASCI P. 126



APPLIQUE GETA LED QUATTRO FASCI P. 127



HOLM SEGNAPASSO P. 128



GARDA LAMPADE DA GIARDINO P. 130



STONE PIETRA DA GIARDINO P. 132



DENVER PROIETTORE BIANCO LUCIDO P. 134



DENVER PROIETTORE NERO SATINATO P. 136



DENVER 20/30N PROIETTORE A LED SLIM NERO SATINATO CON SENSORE DI MOVIMENTO PIR P. 138



MIAMI 10/20/30BW PROIETTORE A LED SLIM BIANCO P. 140



MIAMI 10/20/30N PROIETTORE A LED SLIM NERO LUCIDO P. 140



MIAMI 20N MW PROIETTORE A LED SLIM NERO LUCIDO CON SENSORE DI MOVIMENTO MICROONDE P. 141



DALLAS SMALL 30/50BW PROIETTORE A LED BIANCO PROFESSIONAL P. 142



DALLAS SMALL 30/50N PROIETTORE A LED NERO PROFESSIONAL P. 143



DALLAS BIG 100/150/200N PROIETTORE A LED NERO PROFESSIONAL P. 144



NEW YORK 40/80G PROIETTORE A LED ANTRACITE PROFESSIONAL P. 146



TOKYO 150/200N PROIETTORE A LED NERO PROFESSIONAL P. 147



AKRON 20N P. 148



STAND PER PROIETTORE P. 148



PLAFONIERA STAGNA LED P. 149



SCHERMO DI RICAMBIO P. 149



HIGH BAY A LED P. 150



STAFFA OPZIONALE PER HIGH BAY P. 150



DIFFUSORE OPZIONALE PER HIGH BAY 60°/90° P. 150

## APPARECCHI A LED LUCE NOTTURNA E PORTATILI



LUCE NOTTURNA POWER LED P. 154



LUCE NOTTURNA POWER LED CREPUSCOLARE P. 154



LUCE NOTTURNA POWER LED CREPUSCOLARE P. 154



LUCE NOTTURNA POWER LED CREPUSCOLARE P. 155

# INDICE

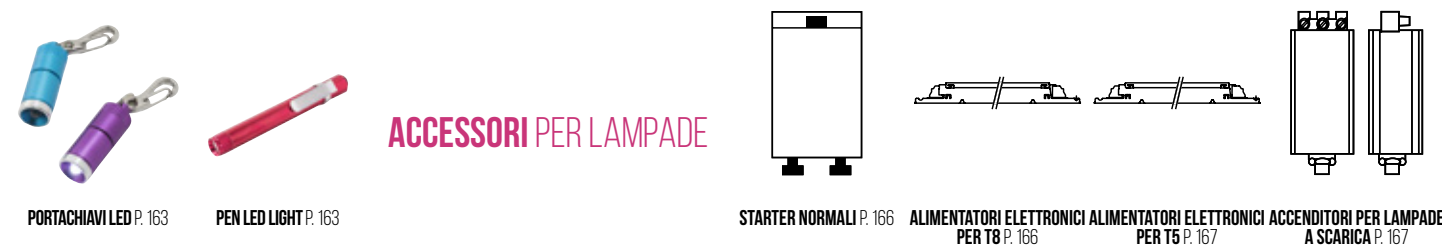

## PILE ELETTRICHE



EVOLUTION + ALKALINE P. 170



SUPERALKALINE P. 170



ALKALINE P. 171



LITHIUM P. 171



## LAMPADE A LED

Da oltre 12 anni Bot Lighting crede ed investe nella tecnologia LED applicata all'illuminazione generale ed in particolare alla lampadina.

Grazie all'esperienza maturata è riuscita a migliorare e perfezionare i propri prodotti in modo da offrire una gamma completa ed adatta ad ogni esigenza, riuscendo a garantire una qualità adeguata ad ogni applicazione.

La lampadina LED Bot Lighting è caratterizzata da elevate prestazioni in relazione alle ridotte dimensioni, elevata efficienza energetica (quasi tutte le lampade a LED sono in classe A+ ed A++) e lunghissima durata di vita, superiore a quella di qualunque lampada costruita con tecnologia tradizionale. La lampada a LED di Bot Lighting è la soluzione ideale, si potrebbe quasi dire obbligata, per la sostituzione delle sorgenti luminose di vecchia generazione in un'ottica di risparmio energetico e sostenibilità ecologica.

## PIÙ RISPARMIO ENERGETICO

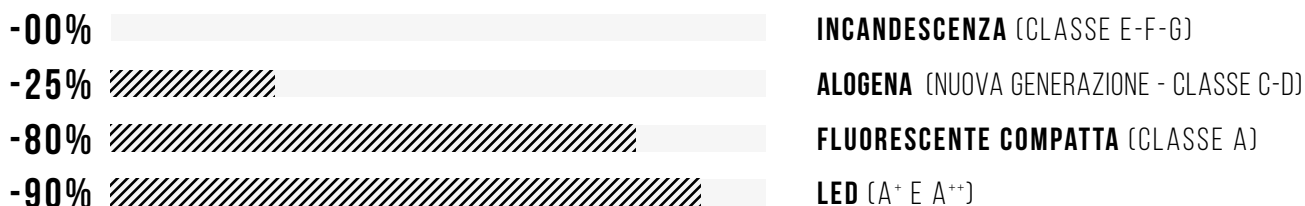

## SOLUZIONI LED

L'illuminazione LED rende unici gli uffici, abbellisce gli spazi esterni e fornisce soluzioni a risparmio energetico agli alberghi. Le soluzioni LED offrono prodotti particolarmente adatti ai punti vendita, possono essere usati per mettere in evidenza un prodotto, creare un'atmosfera e attirare l'interesse, ma possono anche riflettere uno stato d'animo. Grazie alla durata eccezionale e all'elevata efficienza energetica, le riduzioni dei costi energetici sono davvero significativi.

In certe aree degli alberghi, uffici, aree commerciali, sono necessarie delle applicazioni accese 24 ore su 24: nei corridoi, nei passaggi comuni, o al banco della reception. Le soluzioni LED possono creare un'atmosfera confortevole e calda, lo possono fare offrendo contemporaneamente enormi vantaggi in termini di riduzione dei costi di manutenzione ed energetici. Le soluzioni LED richiedono un basso livello di manutenzione, riducendo così i costi d'esercizio.

**NON CONTENGONO SOSTANZE NOCIVE PER L'AMBIENTE COME PIOMBO E MERCURIO**

---

## CARATTERISTICHE VINCENTI

---

L'illuminazione a LED è ormai universalmente considerata come la soluzione vincente tra quelle oggi presenti sul mercato.

Il primo aspetto evidente è il ridottissimo consumo energetico che ne fa una tecnologia sostenibile, anche in virtù dell'assenza di sostanze dannose per l'ambiente e della lunga durata di esercizio, che si traduce nella riduzione di risorse utilizzate e di rifiuti prodotti. A conti fatti la soluzione LED è tra tutte la più economica, ma oltre all'economia di esercizio vi sono innumerevoli altre ragioni per scegliere il led, come ad esempio la flessibilità di impiego dovuta all'ampia gamma di forme, la possibilità di disporre di diverse colorazioni di luce e le ottime prestazioni illuminotecniche.

DESIGN MODERNO

ACCENSIONE Istantanea  
AL 100%

OTTIMA RESA CROMATICA

ECCELLENTE QUALITÀ  
DELLA LUCE PER SODDISFARE  
QUALSIASI ESIGENZA

AMPIO FASCIO LUMINOSO

LUNGA DURATA

QUALITÀ GARANTITA

HG MERCURY FREE

---

## CLASSE ENERGETICA

---

Il Regolamento Delegato n.874/2012, che entrerà in vigore dal 1° settembre 2013, stabilisce nuovi criteri per la classificazione dell'efficienza energetica delle lampade e degli apparecchi di illuminazione. In particolare vengono istituite le nuove classi A+ ed A++ per i prodotti tecnologicamente più avanzati che superano la vecchia classe A. Gran parte delle lampade a LED Bot Lighting raggiungono già la classificazione A+ e A++, anticipando quindi una nuova generazione di lampade a LED più efficienti ed economiche.

Il LED è il CUORE della lampada, e i LED non sono tutti uguali.

Scegliere un buon chip influenza:

- **La quantità della luce emessa** (efficienza e flusso luminoso)
- **La qualità della luce emessa** (colore - CRI)
- **La durata nel tempo** (stabilità del colore - lumen maintenance)

## GARANZIA LAMPADE A LED BOTLIGHTING

Qualità del prodotto, tecnologia innovativa, durata e caratteristiche illuminotecniche risultano gli elementi vincenti delle lampade a LED di Bot Lighting, per questo motivo abbiamo deciso di offrire un vantaggio esclusivo al nostro cliente.

**2** ANNI  
YEARS  
WARRANTY  
GARANZIA

LAMPADE CON VITA  
MEDIA NOMINALE  
**< 25.000 ORE**

**3** ANNI  
YEARS  
WARRANTY  
GARANZIA

LAMPADE CON VITA  
MEDIA NOMINALE  
**≥ 25.000 ORE**  
E MINORE DI  
**40.000 ORE**

**5** ANNI  
YEARS  
WARRANTY  
GARANZIA

LAMPADE CON VITA  
MEDIA NOMINALE  
**≥ 40.000 ORE**

La presente garanzia copre esclusivamente i Prodotti impiegati alle seguenti condizioni di utilizzo che devono verificarsi contemporaneamente ai fini della copertura di garanzia:

- I prodotti devono essere installati correttamente ed utilizzati secondo le istruzioni.
- I prodotti devono funzionare in un range di tensione pari a 230 V +/- 10%.
- L'umidità nell'impianto non superi mai l'80%
- Il periodo di garanzia presuppone un utilizzo di funzionamento massimo di 4.000 ore all'anno ad una temperatura costante di 25 ° con 10 mm. minimo di spazio intorno alla lampada.
- Il periodo di garanzia decorre a partire dalla data di acquisto riportata sulla fattura/scontrino fiscale e/o dal lotto di produzione riportato su ciascun prodotto.

Approfondimento termini e condizioni di garanzia  
[www.botlighting.it/garanzia](http://www.botlighting.it/garanzia)

## BOT LIGHTING CONTINUA AD INVESTIRE NELLA RICERCA

L'esigenza di avere un laboratorio di misura che possa chiarire in modo veloce e preciso ogni aspetto del funzionamento di una sorgente luminosa è sempre stato sentito da Bot Lighting, azienda che sin dalle sue origini ha fatto della qualità e dell'affidabilità dei propri prodotti la propria bandiera.

Con l'avvento delle sorgenti a LED il numero di variabili e di informazioni da tenere sotto controllo è cresciuto enormemente, ed è per questa ragione che Bot Lighting ha varato un piano di investimenti per potenziare il laboratorio nella sua sede di Pianiga (VE).

Il laboratorio è ora dotato di macchinari di ultimissima generazione che permettono di effettuare tutte le principali verifiche illuminotecniche (e non solo) in modo veloce e preciso, in tal modo sia le attività di R&D sia il controllo qualità sono stati fortemente potenziati.

Possiamo inoltre supportare le attività di progetto fornendo ai nostri clienti tutti i dati relativi alle nostre sorgenti luminose, siano esse lampadine o apparecchi completi, e dove tali dati non fossero immediatamente disponibili li possiamo misurare in breve tempo.

Non ultimo come importanza è infine il fatto di poter eseguire analisi di natura commerciale monitorando continuamente il mercato mediante la comparazione dei nostri prodotti con quelli dei principali competitor di riferimento.

### R&D CONTROLLO QUALITÀ



### PROGETTI ANALISI COMMERCIALI



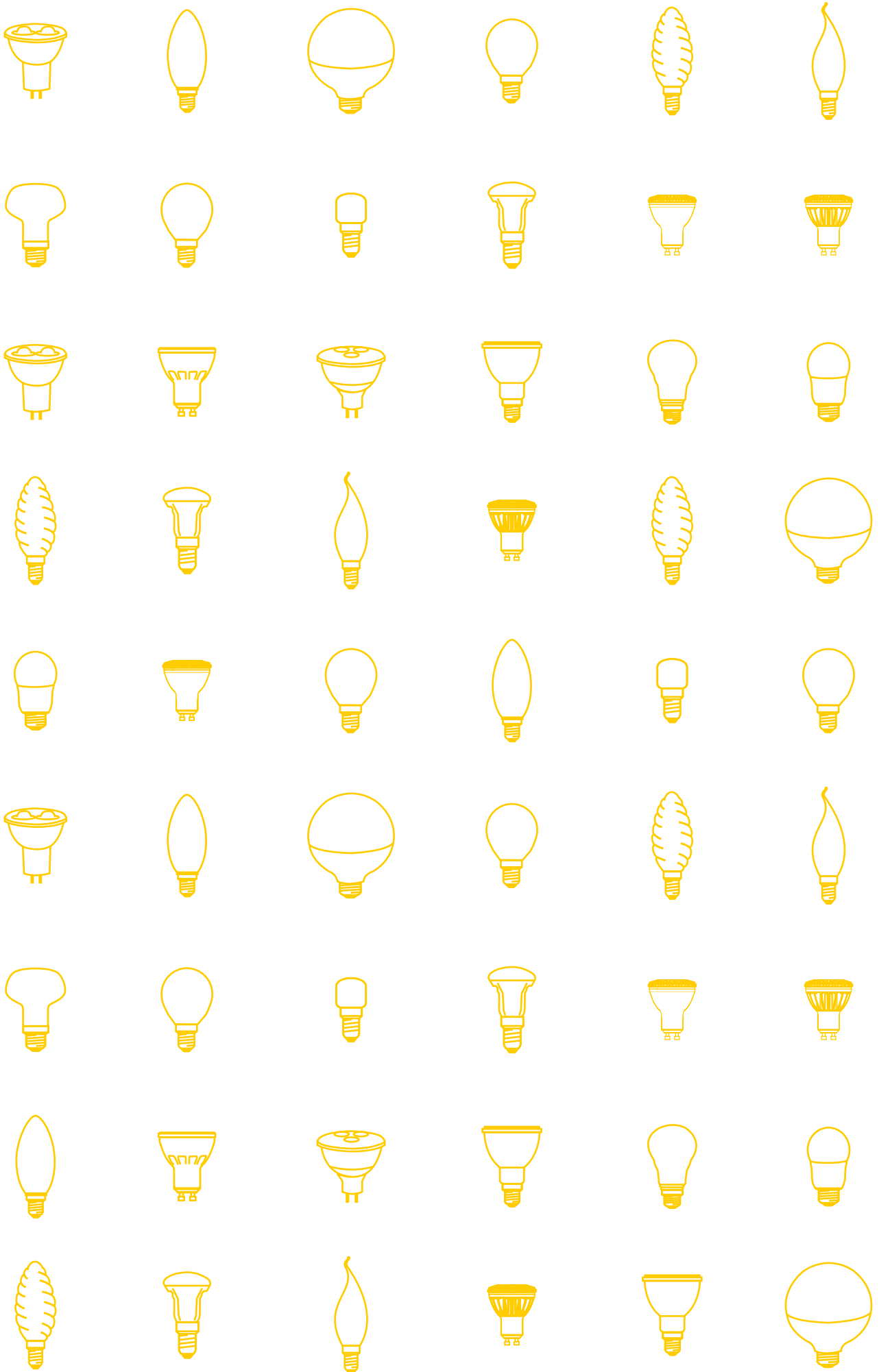



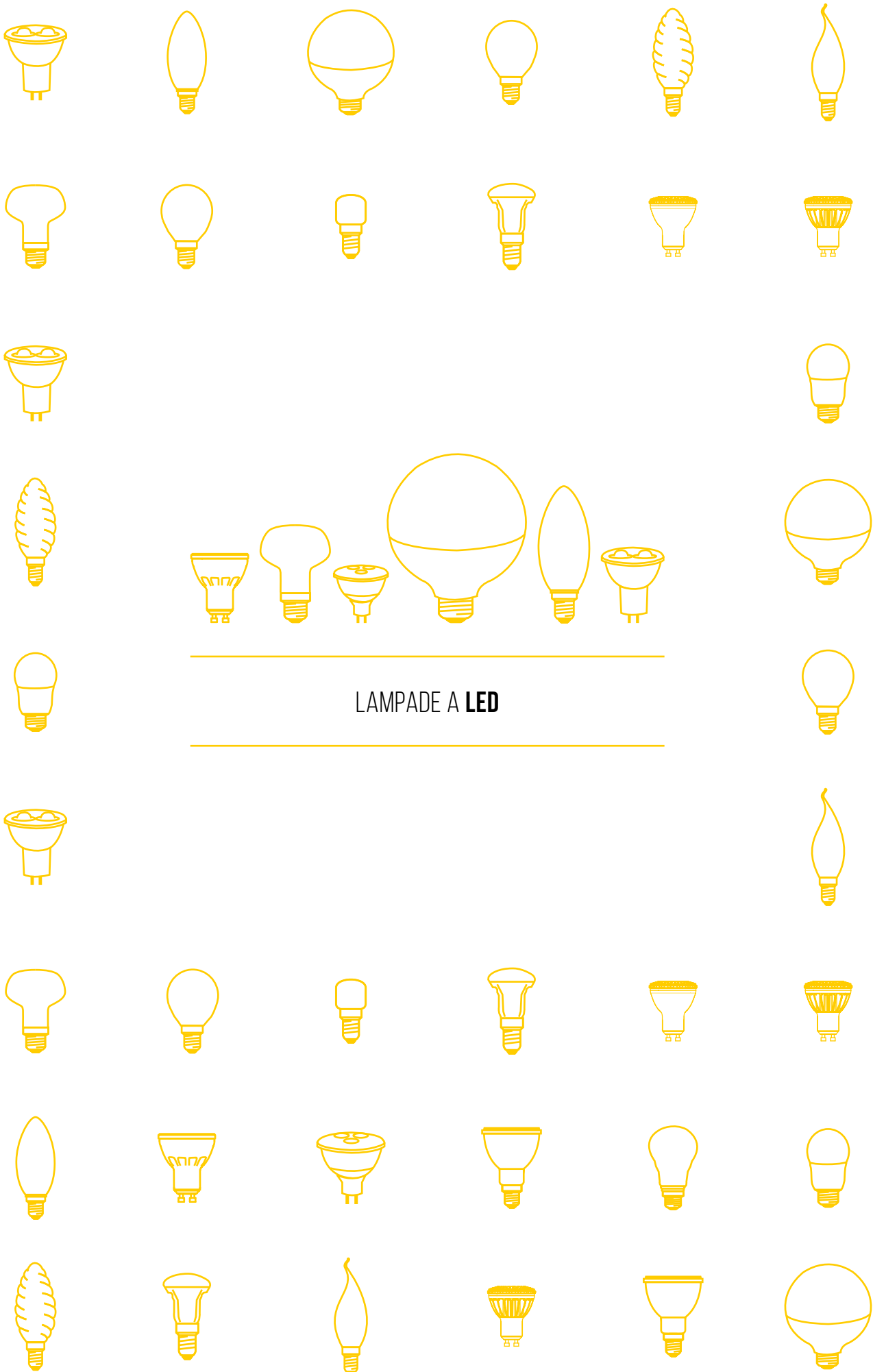



**GOCCIA FULL LIGHT 220-240V**

NEW

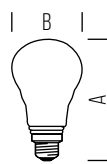
CATEGORIA SCONTO 21



DIMENSIONI	A	B
1	104	60
2	126	70

 ENERGY CLASS **A<sup>+</sup>**

 ENERGY CLASS **A<sup>++</sup>**

 MERCURY **FREE**
**15,000 H**  
**YEARS<sup>1</sup>**

NOT DIMMABLE

**INSTANT**
**10,000**

POTENZA WATT	EQUIVALENZA WATT	BASE	KELVIN	LUMEN LM	LUMEN UTILI	CANDELE CD	FASCIO °	MISURE MM	CODICE	EAN	IMBALLO	PREZZO € IVA ESCLUSA
7,5	60	E27	2700	806	-	-	360	1	<b>MLD1008X2</b>	8031453018900	10	7,80
8,0	75	E27	2700	1055	-	-	360	1	<b>MLD1010X2</b>	8031453018917	10	9,60
11,0	94	E27	2700	1400	-	-	360	2	<b>MLD1011X2</b>	8031453018924	10	19,90

**SFERA FULL LIGHT 220-240V**

NEW

CATEGORIA SCONTO 21

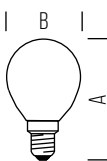

DIMENSIONI	A	B
1	80	45

NOT DIMMABLE

 ENERGY CLASS **A<sup>++</sup>**

 MERCURY **FREE**
**15,000 H**  
**YEARS<sup>1</sup>**
**INSTANT**
**10,000**

POTENZA WATT	EQUIVALENZA WATT	BASE	KELVIN	LUMEN LM	LUMEN UTILI	CANDELE CD	FASCIO °	MISURE MM	CODICE	EAN	IMBALLO	PREZZO € IVA ESCLUSA
4,5	40	E14	2700	470	-	-	360	1	<b>MLD3004X2</b>	8031453018948	10	5,90

**SFERA FULL LIGHT 220-240V**

NEW

CATEGORIA SCONTO 21

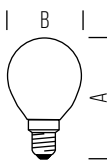

DIMENSIONI	A	B
1	78	45

NOT DIMMABLE

 ENERGY CLASS **A<sup>++</sup>**

 MERCURY **FREE**
**15,000 H**  
**YEARS<sup>1</sup>**
**INSTANT**
**10,000**

POTENZA WATT	EQUIVALENZA WATT	BASE	KELVIN	LUMEN LM	LUMEN UTILI	CANDELE CD	FASCIO °	MISURE MM	CODICE	EAN	IMBALLO	PREZZO € IVA ESCLUSA
4,5	40	E27	2700	470	-	-	360	1	<b>MLD3104X2</b>	8031453018955	10	5,90



## OLIVA FULL LIGHT 220-240V

NEW  
CATEGORIA SCONTO 21

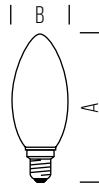

DIMENSIONI	A	B
1	97	35



POTENZA WATT	EQUIVALENZA WATT	BASE	KELVIN	LUMEN LM	LUMEN UTILI	CANDELE CD	FASCIO °	MISURE MM	CODICE	EAN	IMBALLO	PREZZO € IVA ESCLUSA
4,5	40	E27	2700	470	-	-	360	1	MLD2004X2	8031453018931	10	5,90



## GLOBO 95 FULL LIGHT 220-240V

NEW  
CATEGORIA SCONTO 21

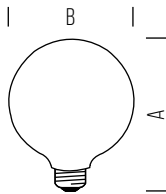

DIMENSIONI	A	B
1	140	95



POTENZA WATT	EQUIVALENZA WATT	BASE	KELVIN	LUMEN LM	LUMEN UTILI	CANDELE CD	FASCIO °	MISURE MM	CODICE	EAN	IMBALLO	PREZZO € IVA ESCLUSA
7,5	60	E27	2700	806	-	-	360	1	MLD4208X2	8031453018978	10	10,40



## GLOBO 126 FULL LIGHT 220-240V

NEW  
CATEGORIA SCONTO 21

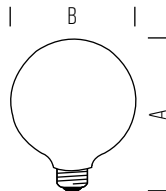

DIMENSIONI	A	B
1	178	125



POTENZA WATT	EQUIVALENZA WATT	BASE	KELVIN	LUMEN LM	LUMEN UTILI	CANDELE CD	FASCIO °	MISURE MM	CODICE	EAN	IMBALLO	PREZZO € IVA ESCLUSA
7,5	60	E27	2700	806	-	-	360	1	MLD4008X2	8031453018962	10	13,20
8	75	E27	2700	1060	-	-	360	1	MLD4010X2	8031453019495	10	13,70

Bot Lighting migliora la tecnologia delle lampade a filamento LED per ottenere prestazioni di assoluta eccellenza con un look tradizionale.

Tutti i componenti sono stati analizzati ed ottimizzati in modo da garantire la massima affidabilità, particolare attenzione è stata riservata allo smaltimento del calore ed alla stabilità dei parametri di funzionamento.

L'impiego delle tecnologie più moderne ci consente di realizzare lampade estremamente efficienti anche se la tonalità di luce molto calda e l'ampolla esterna completamente in vetro permettono di ricreare una atmosfera old style.

Sul LED STICK vengono poi montati un numero variabile di chips ed infine viene steso un doppio strato di fosfori da cui dipende il colore finale della luce emessa.

Con questa tecnologia brevettata è pertanto possibile utilizzare bulbi completamente trasparenti e si ottiene una diffusione luminosa a 360°.

## AMBIENTE SOTTOVUOTO

L'ampolla di vetro viene dapprima lavata internamente e poi, prima del riempimento finale, viene creato il vuoto in modo da eliminare ogni residuo di polvere o vapore acqueo.

## STRUTTURA INTERNA

La peculiare disposizione interna consente di utilizzare un numero variabile di filamenti e di realizzare quindi una gamma virtualmente infinita di possibili potenze.



## FILAMENTO

I filamenti LED (LED STICK) sono realizzati all'interno dei nostri stabilimenti di produzione utilizzando materie prime di elevata qualità e macchinari di avanguardia progettati appositamente. Il supporto è realizzato in zaffiro artificiale o in materiale ceramico a seconda della potenza e delle necessità di dissipazione termica in modo da garantire una temperatura di esercizio ottimale e conseguentemente l'affidabilità e la durata della lampada.

## DRIVER A CORRENTE COSTANTE



Lo scopo del driver è quello di fornire ai chip LED un'alimentazione elettrica quanto più stabile e costante possibile. Per questo motivo nella virola viene inserito un alimentatore a corrente costante realizzato mediante l'impiego di circuiti integrati. Particolare attenzione è stata posta nella realizzazione di un driver miniaturizzato per le virole E14.

## GAS DI RIEMPIMENTO

L'ampolla sottovuoto viene successivamente riempita di Elio. L'Elio grazie alla sua conducibilità termica relativamente elevata concorre allo smaltimento del calore generato all'interno della lampada.



## GOCCIA LED STICK 220-240V

AGGIORNATO

CATEGORIA SCONTO 21

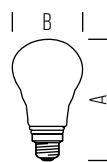

DIMENSIONI	A	B
1	104	60
2	120	67



ENERGY CLASS A++



15,000 H YEARS



6.000

POTENZA WATT	EQUIVALENZA WATT	BASE	KELVIN	LUMEN LM	LUMEN UTILI	CANDELE CD	FASCIO °	MISURE MM	CODICE	EAN	IMBALLO	PREZZO € IVA ESCLUSA
4,0	40	E27	2700	470	-	-	360	1	WLD1004X2	8031453008086	10	5,25
7,0	60	E27	2700	806	-	-	360	1	WLD1008X2	8031453011918	10	6,30
<b>NEW</b> 7,0	60	E27	4000	806	-	-	360	1	WLD1008X3	8031453017026	10	6,30
<b>NEW</b> 7,0	60	E27	6500	806	-	-	360	1	WLD1008X1	8031453016999	10	6,30
8,0	75	E27	2700	1055	-	-	360	1	WLD1010X2	8031453014599	10	8,65
<b>NEW</b> 8,0	75	E27	4000	1055	-	-	360	1	WLD1010X3	8031453016937	10	8,65
<b>NEW</b> 8,0	75	E27	6500	1055	-	-	360	1	WLD1010X1	8031453016968	10	8,65
<b>NEW</b> 11,0	100	E27	2700	1521	-	-	360	2	WLD1011X2	8031453016609	10	15,10
<b>NEW</b> 11,0	100	E27	4000	1521	-	-	360	2	WLD1011X3	8031453016876	10	15,10
<b>NEW</b> 11,0	100	E27	6500	1521	-	-	360	2	WLD1011X1	8031453016906	10	15,10



## GOCCIA LED STICK 220-240V DIMMERABILE

NEW

CATEGORIA SCONTO 21

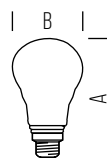

DIMENSIONI	A	B
1	104	60



ENERGY CLASS A++



15,000 H YEARS



6.000

POTENZA WATT	EQUIVALENZA WATT	BASE	KELVIN	LUMEN LM	LUMEN UTILI	CANDELE CD	FASCIO °	MISURE MM	CODICE	EAN	IMBALLO	PREZZO € IVA ESCLUSA
7,5	60	E27	2700	806	-	-	360	1	WLD1008X2D	8031453017750	10	9,60

**SFERA LED STICK 220-240V**
**AGGIORNATO**

CATEGORIA SCONTO 21

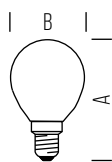

DIMENSIONI	A	B
1	80	45



POTENZA WATT	EQUIVALENZA WATT	BASE	KELVIN	LUMEN LM	LUMEN UTILI	CANDELE CD	FASCIO °	MISURE MM	CODICE	EAN	IMBALLO	PREZZO € IVA ESCLUSA
2,0	25	E14	2700	250	-	-	360	1	WLD3002X2	8031453008413	10	4,60
4,0	40	E14	2700	470	-	-	360	1	WLD3004X2	8031453008444	10	5,40
<b>NEW</b> 4,0	40	E14	4000	470	-	-	360	1	WLD3004X3	8031453016746	10	5,40
<b>NEW</b> 4,0	40	E14	6500	470	-	-	360	1	WLD3004X1	8031453016777	10	5,40

**SFERA LED STICK 220-240V**
**NEW**

CATEGORIA SCONTO 21

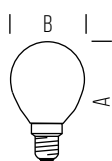

DIMENSIONI	A	B
1	78	45



POTENZA WATT	EQUIVALENZA WATT	BASE	KELVIN	LUMEN LM	LUMEN UTILI	CANDELE CD	FASCIO °	MISURE MM	CODICE	EAN	IMBALLO	PREZZO € IVA ESCLUSA
4,0	40	E27	2700	470	-	-	360	1	WLD3104X2	8031453016630	10	5,40
4,0	40	E27	4000	470	-	-	360	1	WLD3104X3	8031453016685	10	5,40
4,0	40	E27	6500	470	-	-	360	1	WLD3104X1	8031453016715	10	5,40

**OLIVA LED STICK 220-240V**
**AGGIORNATO**

CATEGORIA SCONTO 21

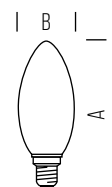

DIMENSIONI	A	B
1	97	35



POTENZA WATT	EQUIVALENZA WATT	BASE	KELVIN	LUMEN LM	LUMEN UTILI	CANDELE CD	FASCIO °	MISURE MM	CODICE	EAN	IMBALLO	PREZZO € IVA ESCLUSA
2,0	25	E14	2700	250	-	-	360	1	WLD2002X2	8031453008352	10	4,60
<b>NEW</b> 2,0	25	E14	4000	250	-	-	360	1	WLD2002X3	8031453019327	10	4,60
4,0	40	E14	2700	470	-	-	360	1	WLD2004X2	8031453008383	10	5,40
<b>NEW</b> 4,0	40	E14	4000	470	-	-	360	1	WLD2004X3	8031453016814	10	5,40
<b>NEW</b> 4,0	40	E14	6500	470	-	-	360	1	WLD2004X1	8031453016845	10	5,40



## OLIVA LED STICK 220-240V DIMMERABILE

**NEW**  
CATEGORIA SCONTO 21

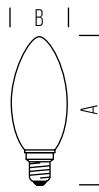

DIMENSIONI	A	B
1	97	35



POTENZA WATT	EQUIVALENZA WATT	BASE	KELVIN	LUMEN LM	LUMEN UTILI	CANDELE CD	FASCIO °	MISURE MM	CODICE	EAN	IMBALLO	PREZZO € IVA ESCLUSA
5,0	40	E14	2700	470	-	-	360	1	WLD2004X2D	8031453019372	10	10,50



## TUBOLARE T25 LED STICK 220-240V

**NEW**  
CATEGORIA SCONTO 21



DIMENSIONI	A	B
1	90	25



POTENZA WATT	EQUIVALENZA WATT	BASE	KELVIN	LUMEN LM	LUMEN UTILI	CANDELE CD	FASCIO °	MISURE MM	CODICE	EAN	IMBALLO	PREZZO € IVA ESCLUSA
4,0	40	E14	2700	470	-	-	360	1	WLD7604X2	8031453017729	50	7,00



## GLOBO 126 LED STICK 220-240V

**AGGIORNATO**  
CATEGORIA SCONTO 21

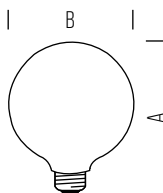

DIMENSIONI	A	B
1	178	125



POTENZA WATT	EQUIVALENZA WATT	BASE	KELVIN	LUMEN LM	LUMEN UTILI	CANDELE CD	FASCIO °	MISURE MM	CODICE	EAN	IMBALLO	PREZZO € IVA ESCLUSA
2,0	25	E27	2700	250	-	-	360	1	WLD4002X2	8031453008147	5	9,30
4,0	40	E27	2700	470	-	-	360	1	WLD4004X2	8031453008178	5	10,30
7,0	60	E27	2700	806	-	-	360	1	WLD4008X2	8031453014650	5	11,50
<b>NEW</b> 8,0	75	E27	2700	1055	-	-	360	1	WLD4010X2	8031453011369	5	13,80
<b>NEW</b> 8,0	75	E27	4000	1055	-	-	360	1	WLD4010X3	8031453019402	5	13,80

**GLOBO 126 LED STICK 220-240V DIMMERABILE**

NEW

CATEGORIA SCONTO 21

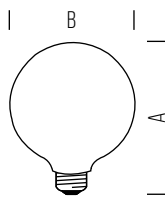

DIMENSIONI	A	B
1	178	125



POTENZA WATT	EQUIVALENZA WATT	BASE	KELVIN	LUMEN LM	LUMEN UTILI	CANDELE CD	FASCIO °	MISURE MM	CODICE	EAN	IMBALLO	PREZZO € IVA ESCLUSA
3,0	25	E27	2700	250	-	-	360	1	WLD4002X2D	8031453017811	5	10,50
7,5	60	E27	2700	806	-	-	360	1	WLD4008X2D	8031453017781	5	14,80

**GOCCIA LED STICK CUPOLA ARGENTATA 220-240V**

CATEGORIA SCONTO 21

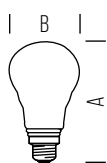

DIMENSIONI	A	B
1	104	60



POTENZA WATT	EQUIVALENZA WATT	BASE	KELVIN	LUMEN LM	LUMEN UTILI	CANDELE CD	FASCIO °	MISURE MM	CODICE	EAN	IMBALLO	PREZZO € IVA ESCLUSA
7,5	48	E27	2700	600	-	-	360	1	WLD1008X2CA	8031453014018	10	13,70

**SFERA LED STICK CUPOLA ARGENTATA 220-240V**

CATEGORIA SCONTO 21

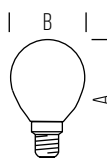

DIMENSIONI	A	B
1	80	45



POTENZA WATT	EQUIVALENZA WATT	BASE	KELVIN	LUMEN LM	LUMEN UTILI	CANDELE CD	FASCIO °	MISURE MM	CODICE	EAN	IMBALLO	PREZZO € IVA ESCLUSA
4,0	30	E14	2700	320	-	-	360	1	WLD3005X2CA	8031453014049	10	10,70





## GOCCIA LED STICK SATINATA 220-240V

CATEGORIA SCONTO 21

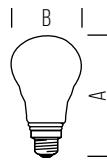

DIMENSIONI	A	B
1	104	60



POTENZA WATT	EQUIVALENZA WATT	BASE	KELVIN	LUMEN LM	LUMEN UTILI	CANDELE CD	FASCIO °	MISURE MM	CODICE	EAN	IMBALLO	PREZZO € IVA ESCLUSA
7,0	60	E27	2700	806	-	-	360	1	WLD1008X2S	8031453014629	10	6,40



## SFERA LED STICK SATINATA 220-240V

AGGIORNATO

CATEGORIA SCONTO 21

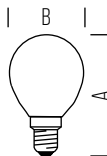

DIMENSIONI	A	B
1	80	45



POTENZA WATT	EQUIVALENZA WATT	BASE	KELVIN	LUMEN LM	LUMEN UTILI	CANDELE CD	FASCIO °	MISURE MM	CODICE	EAN	IMBALLO	PREZZO € IVA ESCLUSA
<b>NEW</b> 2,0	25	E14	2700	250	-	-	360	1	WLD3002X2S	8031453009076	10	4,70
4,0	40	E14	2700	470	-	-	360	1	WLD3004X2S	8031453009106	10	5,50
<b>NEW</b> 4,0	40	E14	4000	470	-	-	360	1	WLD3004X3S	8031453019365	10	5,50



## SFERA LED STICK SATINATA 220-240V

AGGIORNATO

CATEGORIA SCONTO 21

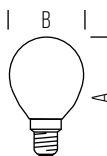

DIMENSIONI	A	B
1	80	45



POTENZA WATT	EQUIVALENZA WATT	BASE	KELVIN	LUMEN LM	LUMEN UTILI	CANDELE CD	FASCIO °	MISURE MM	CODICE	EAN	IMBALLO	PREZZO € IVA ESCLUSA
4,0	40	E27	2700	470	-	-	360	1	WLD3104X2S	8031453011949	10	5,50



**OLIVA LED STICK SATINATA 220-240V**

AGGIORNATO

CATEGORIA SCONTO 21

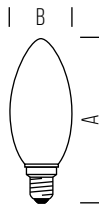

DIMENSIONI	A	B
1	97	35



POTENZA WATT	EQUIVALENZA WATT	BASE	KELVIN	LUMEN LM	LUMEN UTILI	CANDELE CD	FASCIO °	MISURE MM	CODICE	EAN	IMBALLO	PREZZO € IVA ESCLUSA
2,0	25	E14	2700	250	-	-	360	1	WLD2002X2S	8031453009014	10	4,70
4,0	40	E14	2700	470	-	-	360	1	WLD2004X2S	8031453009045	10	5,50
4,0	40	E14	4000	470	-	-	360	1	WLD2004X3S	8031453019334	10	5,50

NEW



**OLIVA LED STICK SATINATA 220-240V DIMMERABILE**

NEW

CATEGORIA SCONTO 21

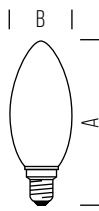

DIMENSIONI	A	B
1	97	35



POTENZA WATT	EQUIVALENZA WATT	BASE	KELVIN	LUMEN LM	LUMEN UTILI	CANDELE CD	FASCIO °	MISURE MM	CODICE	EAN	IMBALLO	PREZZO € IVA ESCLUSA
5,0	40	E14	2700	470	-	-	360	1	WLD2004X2SD	8031453019389	10	6,50



**TORTIGLIONE LED STICK SATINATA 220-240V**

AGGIORNATO

CATEGORIA SCONTO 21

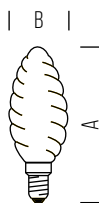

DIMENSIONI	A	B
1	97	35



POTENZA WATT	EQUIVALENZA WATT	BASE	KELVIN	LUMEN LM	LUMEN UTILI	CANDELE CD	FASCIO °	MISURE MM	CODICE	EAN	IMBALLO	PREZZO € IVA ESCLUSA
4,0	40	E14	2700	470	-	-	360	1	WLD2004T2S	8031453011338	10	5,65
4,0	40	E14	4000	470	-	-	360	1	WLD2004T3S	8031453019358	10	5,65

NEW



## FIAMMA LED STICK SATINATA 220-240V

AGGIORNATO

CATEGORIA SCONTO 21

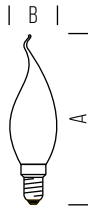

DIMENSIONI	A	B
1	123	35



POTENZA WATT	EQUIVALENZA WATT	BASE	KELVIN	LUMEN LM	LUMEN UTILI	CANDELE CD	FASCIO °	MISURE MM	CODICE	EAN	IMBALLO	PREZZO € IVA ESCLUSA
4,0	40	E14	2700	470	-	-	360	1	WLD2004F2S	8031453011307	10	5,50
4,0	40	E14	4000	470	-	-	360	1	WLD2004F3S	8031453019341	10	5,50

NEW



## GLOBO 126 LED STICK SATINATA 220-240V

AGGIORNATO

CATEGORIA SCONTO 21

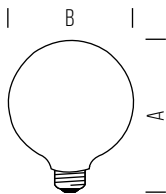

DIMENSIONI	A	B
1	178	125



POTENZA WATT	EQUIVALENZA WATT	BASE	KELVIN	LUMEN LM	LUMEN UTILI	CANDELE CD	FASCIO °	MISURE MM	CODICE	EAN	IMBALLO	PREZZO € IVA ESCLUSA
10,0	75	E27	2700	1060	-	-	360	1	WLD4010X2S	8031453012236	5	14,50



## REFLECTOR R63 LED STICK SATINATA 220-240V

AGGIORNATO

CATEGORIA SCONTO 21

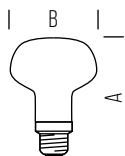

DIMENSIONI	A	B
1	102	63



POTENZA WATT	EQUIVALENZA WATT	BASE	KELVIN	LUMEN LM	LUMEN UTILI	CANDELE CD	FASCIO °	MISURE MM	CODICE	EAN	IMBALLO	PREZZO € IVA ESCLUSA
5,0	28	E27	2700	300	-	-	110	1	WLD500552	8031453014322	10	11,10



**REFLECTOR R80 LED STICK SATINATA 220-240V**

AGGIORNATO

CATEGORIA SCONTO 21

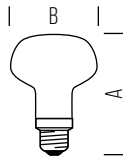

DIMENSIONI	A	B
1	114	80



POTENZA WATT	EQUIVALENZA WATT	BASE	KELVIN	LUMEN LM	LUMEN UTILI	CANDELE CD	FASCIO °	MISURE MM	CODICE	EAN	IMBALLO	PREZZO € IVA ESCLUSA
6,5	37	E27	2700	420	-	-	110	1	WLD500652	8031453014353	10	12,90



**REFLECTOR R125 LED STICK SATINATA 220-240V**

NEW

CATEGORIA SCONTO 21

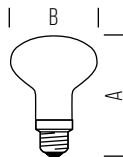

DIMENSIONI	A	B
1	175	125



POTENZA WATT	EQUIVALENZA WATT	BASE	KELVIN	LUMEN LM	LUMEN UTILI	CANDELE CD	FASCIO °	MISURE MM	CODICE	EAN	IMBALLO	PREZZO € IVA ESCLUSA
8,0	66	E27	2700	900	-	-	110	1	WLD500952	8031453019396	10	19,00





**GOCCIA LED STICK AMBER 220-240V**

CATEGORIA SCONTO 21

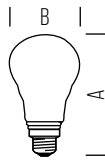

DIMENSIONI	A	B
1	104	60



POTENZA WATT	EQUIVALENZA WATT	BASE	KELVIN	LUMEN LM	LUMEN UTILI	CANDELE CD	FASCIO °	MISURE MM	CODICE	EAN	IMBALLO	PREZZO € IVA ESCLUSA
4,0	34	E27	2000	380	-	-	360	1	WLD1004X2AM	8031453014681	10	10,70



**OLIVA LED STICK AMBER 220-240V**

CATEGORIA SCONTO 21

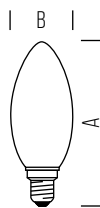

DIMENSIONI	A	B
1	97	35



POTENZA WATT	EQUIVALENZA WATT	BASE	KELVIN	LUMEN LM	LUMEN UTILI	CANDELE CD	FASCIO °	MISURE MM	CODICE	EAN	IMBALLO	PREZZO € IVA ESCLUSA
2,0	19	E14	2000	190	-	-	360	1	WLD2002X2AM	8031453014711	10	8,60



**GLOBO 95 LED STICK AMBER 220-240V**

CATEGORIA SCONTO 21

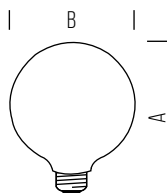

DIMENSIONI	A	B
1	140	95



POTENZA WATT	EQUIVALENZA WATT	BASE	KELVIN	LUMEN LM	LUMEN UTILI	CANDELE CD	FASCIO °	MISURE MM	CODICE	EAN	IMBALLO	PREZZO € IVA ESCLUSA
3,0	26	E27	2000	265	-	-	360	1	WLD4203X2AM	8031453014797	5	17,40



## GLOBO 126 LED STICK AMBER 220-240V

CATEGORIA SCONTO 21

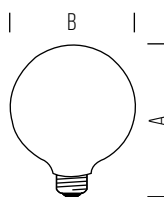

DIMENSION	A	B
1	178	125



POTENZA WATT	EQUIVALENZA WATT	BASE	KELVIN	LUMEN LM	LUMEN UTILI	CANDELE CD	FASCIO °	MISURE MM	CODICE	EAN	IMBALLO	PREZZO € IVA ESCLUSA
3,0	26	E27	2000	265	-	-	360	1	WLD4003X2AM	8031453014773	5	21,30



## EDISON ST58 LED STICK AMBER 220-240V

AGGIORNATO

CATEGORIA SCONTO 21

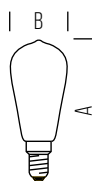

DIMENSIONI	A	B
1	133	58



POTENZA WATT	EQUIVALENZA WATT	BASE	KELVIN	LUMEN LM	LUMEN UTILI	CANDELE CD	FASCIO °	MISURE MM	CODICE	EAN	IMBALLO	PREZZO € IVA ESCLUSA
3,0	26	E27	2000	265	-	-	360	1	WLD7503X2AM	8031453014742	10	15,30

**GOCCIA OPALE 220-240V**

CATEGORIA SCONTO 21

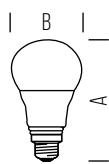

DIMENSIONI	A	B
1	108	60
2	118	60
3	122	60



POTENZA WATT	EQUIVALENZA WATT	BASE	KELVIN	LUMEN LM	LUMEN UTILI	CANDELE CD	FASCIO °	MISURE MM	CODICE	EAN	IMBALLO	PREZZO € IVA ESCLUSA
9,0	60	E27	2700	806	-	-	300	1	SLD1009X2	8031453010874	10	4,85
9,0	60	E27	5000	806	-	-	300	1	SLD1009X1	8031453010843	10	4,85
11,0	75	E27	2700	1060	-	-	300	2	SLD1011X2	8031453010935	10	5,90
11,0	75	E27	5000	1060	-	-	300	2	SLD1011X1	8031453010904	10	5,90
13,0	100	E27	2700	1521	-	-	240	3	SLD1013X2B	8031453013233	10	9,40
13,0	100	E27	5000	1521	-	-	240	3	SLD1013X1B	8031453013264	10	9,40

**GOCCIA OPALE 220-240V DIMMERABILE**

CATEGORIA SCONTO 21

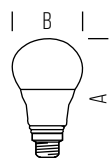

DIMENSIONI	A	B
1	110	60
2	122	60



POTENZA WATT	EQUIVALENZA WATT	BASE	KELVIN	LUMEN LM	LUMEN UTILI	CANDELE CD	FASCIO °	MISURE MM	CODICE	EAN	IMBALLO	PREZZO € IVA ESCLUSA
8,5	60	E27	2700	806	-	-	240	1	SLD1009X2D	8031453014254	10	8,10
13,5	100	E27	2700	1520	-	-	240	2	SLD1014X2D	8031453012113	10	15,70





### GOCCIA OPALE 220-240V CON SENSORE CREPUSCOLARE

NEW

CATEGORIA SCONTO 21

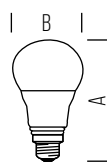

DIMENSIONI	A	B
1	120	60



POTENZA WATT	EQUIVALENZA WATT	BASE	KELVIN	LUMEN LM	LUMEN UTILI	CANDELE CD	FASCIO °	MISURE MM	CODICE	EAN	IMBALLO	PREZZO € IVA ESCLUSA
10,0	75	E27	2700	1060	-	-	240	1	LEDSENS 10X2B	8031453019174	10	14,30
10,0	75	E27	4000	1060	-	-	240	1	LEDSENS 10X3B	8031453019181	10	14,30



### GOCCIA OPALE 220-240V CON SENSORE DI MOVIMENTO

AGGIORNATO

CATEGORIA SCONTO 21

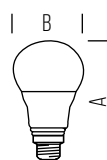

DIMENSIONI	A	B
1	120	60

- Raggio fisso circa 8 metri
- Rimane accesa per 2 minuti



POTENZA WATT	EQUIVALENZA WATT	BASE	KELVIN	LUMEN LM	LUMEN UTILI	CANDELE CD	FASCIO °	MISURE MM	CODICE	EAN	IMBALLO	PREZZO € IVA ESCLUSA
9,0	60	E27	2700	806	-	-	240	1	SLD1009X2M	8031453015022	10	28,70



**3STEP**

Nuova tecnologia **3STEP DIMM** che permette di variare l'intensità luminosa della lampada solamente premendo più volte l'interruttore collegato alla lampada senza utilizzo di alcun dimmer esterno.

La luminosità può essere selezionata tra tre differenti livelli pre impostati:

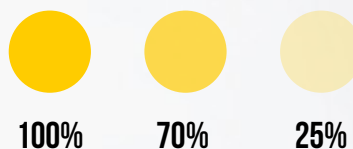

Questa tecnologia permette di risparmiare il costo del dimmer e di avere una lampada pienamente compatibile con il variatore integrato.

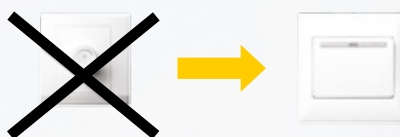

La nuova tecnologia **3STEP** cambia colore permette di variare la temperatura di colore della lampada premendo più volte l'interruttore collegato alla lampada senza nessun dimmer.



## GOCCIA OPALE 220-240V 3STEP DIMMERABILE

CATEGORIA SCONTO 21

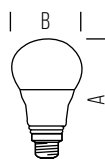

DIMENSIONI	A	B
1	125	60



POTENZA WATT	EQUIVALENZA WATT	BASE	KELVIN	LUMEN LM	LUMEN UTILI	CANDELE CD	FASCIO °	MISURE MM	CODICE	EAN	IMBALLO	PREZZO € IVA ESCLUSA
12,0	75	E27	2700	1060	-	-	240	1	SLD1012X2D3	8031453012083	10	9,30



## GOCCIA OPALE 220-240V 3STEP CCT - LUCE CALDA, LUCE FREDDA, LUCE BIANCA

NEW

CATEGORIA SCONTO 21

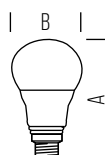

DIMENSIONI	A	B
1	120	60



POTENZA WATT	EQUIVALENZA WATT	BASE	KELVIN	LUMEN LM	LUMEN UTILI	CANDELE CD	FASCIO °	MISURE MM	CODICE	EAN	IMBALLO	PREZZO € IVA ESCLUSA
8,6	60	E27	2700 6500 4000	806	-	-	240	1	SLD1009XCCT3	8031453017842	10	9,99



## GOCCIA OPALE 12/24V AC/DC

AGGIORNATO

CATEGORIA SCONTO 21

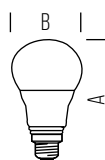

DIMENSIONI	A	B
1	108	60
1	112	60



POTENZA WATT	EQUIVALENZA WATT	BASE	KELVIN	LUMEN LM	LUMEN UTILI	CANDELE CD	FASCIO °	MISURE MM	CODICE	EAN	IMBALLO	PREZZO € IVA ESCLUSA
5,0	35	E27	2700	400	-	-	180	1	LD5505X2DC	8031453004514	10	7,50
9,0	60	E27	2700	806	-	-	180	2	SLD1009X2DC	8031453019198	10	12,70

Si consiglia l'uso di alimentatori led in DC o trasformatori ferromagnetici. Nel caso di trasformatori elettronici in AC verificare il corretto funzionamento ed i valori di corrente e tensione.



### SFERA OPALE 220-240V DIMMERABILE

CATEGORIA SCONTO 21

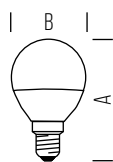

DIMENSIONI	A	B
1	81	45



POTENZA WATT	EQUIVALENZA WATT	BASE	KELVIN	LUMEN LM	LUMEN UTILI	CANDELE CD	FASCIO °	MISURE MM	CODICE	EAN	IMBALLO	PREZZO € IVA ESCLUSA
6,0	40	E14	2700	470	-	-	180	1	SLD3006X2D	8031453012175	10	7,10



### OLIVA OPALE 220-240V DIMMERABILE

CATEGORIA SCONTO 21

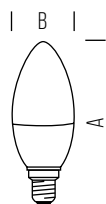

DIMENSIONI	A	B
1	110	38



POTENZA WATT	EQUIVALENZA WATT	BASE	KELVIN	LUMEN LM	LUMEN UTILI	CANDELE CD	FASCIO °	MISURE MM	CODICE	EAN	IMBALLO	PREZZO € IVA ESCLUSA
6,0	40	E14	2700	470	-	-	240	1	SLD2006X2D	8031453012144	10	7,10



### GLOBO 95 OPALE 220-240V

AGGIORNATO

CATEGORIA SCONTO 21

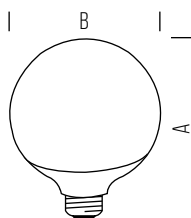

DIMENSIONI	A	B
1	133	95



POTENZA WATT	EQUIVALENZA WATT	BASE	KELVIN	LUMEN LM	LUMEN UTILI	CANDELE CD	FASCIO °	MISURE MM	CODICE	EAN	IMBALLO	PREZZO € IVA ESCLUSA
11,0	75	E27	2700	1055	-	-	240	1	SLD4112X2B	8031453013738	6	8,60
11,0	75	E27	4000	1055	-	-	240	1	SLD4112X3B	8031453018887	6	8,60
11,0	77	E27	6500	1055	-	-	240	1	SLD4112X1B	8031453013714	6	8,60

NEW



## GLOBO 120 OPALE 220-240V

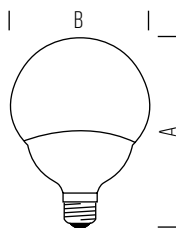

DIMENSIONI	A	B
1	172	120

AGGIORNATO

CATEGORIA SCONTO 21



POTENZA WATT	EQUIVALENZA WATT	BASE	KELVIN	LUMEN LM	LUMEN UTILI	CANDELE CD	FASCIO °	MISURE MM	CODICE	EAN	IMBALLO	PREZZO € IVA ESCLUSA
15,0	100	E27	2700	1521	-	-	240	1	SLD4115X2B	8031453013776	6	11,90
15,0	100	E27	4000	1521	-	-	240	1	SLD4115X3B	8031453018894	6	11,90
15,0	100	E27	6500	1521	-	-	240	1	SLD4115X1B	8031453013752	6	11,90

NEW



## GLOBO 120 OPALE 220-240V

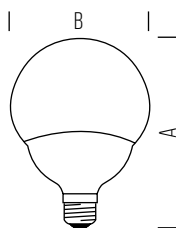

DIMENSIONI	A	B
1	172	120

AGGIORNATO

CATEGORIA SCONTO 21



POTENZA WATT	EQUIVALENZA WATT	BASE	KELVIN	LUMEN LM	LUMEN UTILI	CANDELE CD	FASCIO °	MISURE MM	CODICE	EAN	IMBALLO	PREZZO € IVA ESCLUSA
20,0	120	E27	2700	1900	-	-	240	1	SLD4121X2B	8031453013813	6	14,30
20,0	120	E27	4000	1900	-	-	240	1	SLD4121X3B	8031453018863	6	14,30
20,0	120	E27	6500	1900	-	-	240	1	SLD4121X1B	8031453013790	6	14,30

NEW



## GLOBO 120 OPALE 220-240V

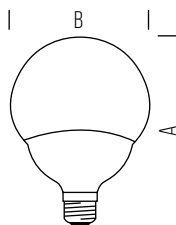

DIMENSIONI	A	B
1	172	120

AGGIORNATO

CATEGORIA SCONTO 21



POTENZA WATT	EQUIVALENZA WATT	BASE	KELVIN	LUMEN LM	LUMEN UTILI	CANDELE CD	FASCIO °	MISURE MM	CODICE	EAN	IMBALLO	PREZZO € IVA ESCLUSA
22,0	145	E27	2700	2450	-	-	200	1	SLD4122X2B	8031453015190	6	16,20
22,0	145	E27	4000	2450	-	-	200	1	SLD4122X3B	8031453018870	6	16,20
22,0	145	E27	6500	2450	-	-	200	1	SLD4122X1B	8031453015176	6	16,20

NEW

**PICCOLA PERA PER FRIGORIFERI 220-240V**

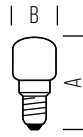
 NEW  
 CATEGORIA SCONTO 21

DIMENSIONI	A	B
1	55	25



POTENZA WATT	EQUIVALENZA WATT	BASE	KELVIN	LUMEN LM	LUMEN UTILI	CANDELE CD	FASCIO °	MISURE MM	CODICE	EAN	IMBALLO	PREZZO € IVA ESCLUSA
1,5	-	E14	6500	110	-	-	180	1	SLD7102X1FRB	8031453018986	20	3,70

**PICCOLA PERA 220-240V**

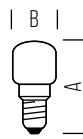
 NEW  
 CATEGORIA SCONTO 21

DIMENSIONI	A	B
1	55	25



POTENZA WATT	EQUIVALENZA WATT	BASE	KELVIN	LUMEN LM	LUMEN UTILI	CANDELE CD	FASCIO °	MISURE MM	CODICE	EAN	IMBALLO	PREZZO € IVA ESCLUSA
1,5	-	E14	3000	110	-	-	180	1	SLD7102X2B	8031453018993	20	3,70

**PICCOLA PERA COLORATA 220-240V**

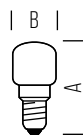
 NEW  
 CATEGORIA SCONTO 21

DIMENSIONI	A	B
1	55	25



POTENZA WATT	EQUIVALENZA WATT	BASE	COLORE	LUMEN LM	LUMEN UTILI	CANDELE CD	FASCIO °	MISURE MM	CODICE	EAN	IMBALLO	PREZZO € IVA ESCLUSA
1,5	-	E14	BLU	-	-	-	180	1	SLD7202XB	8031453019006	20	5,50
1,5	-	E14	GREEN	-	-	-	180	1	SLD7202XG	8031453019013	20	5,50
1,5	-	E14	RED	-	-	-	180	1	SLD7202XR	8031453019020	20	5,50



## TUBOLARI T37 220-240V

NEW  
CATEGORIA SCONTO 21

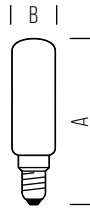

DIMENSIONI	A	B
1	126	38



POTENZA WATT	EQUIVALENZA WATT	BASE	KELVIN	LUMEN LM	LUMEN UTILI	CANDELE CD	FASCIO °	MISURE MM	CODICE	EAN	IMBALLO	PREZZO € IVA ESCLUSA
7,5	60	E14	2700	806	-	-	270	1	SLD7308X2	8031453017941	20	9,45
7,5	60	E14	6500	806	-	-	270	1	SLD7308X1	8031453017910	20	9,45



## TUBOLARI T37 220-240V

NEW  
CATEGORIA SCONTO 21

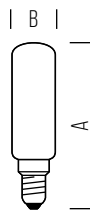

DIMENSIONI	A	B
1	126	38



POTENZA WATT	EQUIVALENZA WATT	BASE	KELVIN	LUMEN LM	LUMEN UTILI	CANDELE CD	FASCIO °	MISURE MM	CODICE	EAN	IMBALLO	PREZZO € IVA ESCLUSA
7,5	60	E27	2700	806	-	-	270	1	SLD7408X2	8031453018009	20	9,45
7,5	60	E27	6500	806	-	-	270	1	SLD7408X1	8031453017972	20	9,45



## TUBOLARI T45 220-240V

NEW  
CATEGORIA SCONTO 21

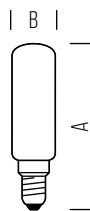

DIMENSIONI	A	B
1	152	45



POTENZA WATT	EQUIVALENZA WATT	BASE	KELVIN	LUMEN LM	LUMEN UTILI	CANDELE CD	FASCIO °	MISURE MM	CODICE	EAN	IMBALLO	PREZZO € IVA ESCLUSA
9,5	75	E27	2700	1055	-	-	270	1	SLD7410X2	8031453018061	20	11,70
9,5	75	E27	6500	1055	-	-	270	1	SLD7410X1	8031453018030	20	11,70



### REFLECTOR R39 220-240V

NEW  
CATEGORIA SCONTO 21

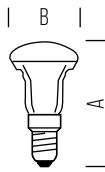

DIMENSIONI	A	B
1	67	39



POTENZA WATT	EQUIVALENZA WATT	BASE	KELVIN	LUMEN LM	LUMEN UTILI	CANDELE CD	FASCIO °	MISURE MM	CODICE	EAN	IMBALLO	PREZZO € IVA ESCLUSA
3,0	25	E14	2700	250	-	-	120	1	SLD500352B	8031453018702	10	4,40
3,0	25	E14	4000	250	-	-	120	1	SLD500353B	8031453018726	10	4,40
3,0	25	E14	6500	250	-	-	120	1	SLD500351B	8031453018689	10	4,40



### REFLECTOR R50 220-240V

NEW  
CATEGORIA SCONTO 21

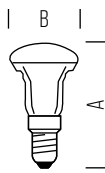

DIMENSIONI	A	B
1	83	50



POTENZA WATT	EQUIVALENZA WATT	BASE	KELVIN	LUMEN LM	LUMEN UTILI	CANDELE CD	FASCIO °	MISURE MM	CODICE	EAN	IMBALLO	PREZZO € IVA ESCLUSA
5,0	40	E14	2700	470	-	-	120	1	SLD500552B	8031453018788	10	5,00
5,0	40	E14	4000	470	-	-	120	1	SLD500553B	8031453018795	10	5,00
5,0	40	E14	6500	470	-	-	120	1	SLD500551B	8031453018740	10	5,00



### REFLECTOR R63 220-240V

NEW  
CATEGORIA SCONTO 21

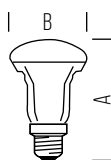

DIMENSIONI	A	B
1	97	63



POTENZA WATT	EQUIVALENZA WATT	BASE	KELVIN	LUMEN LM	LUMEN UTILI	CANDELE CD	FASCIO °	MISURE MM	CODICE	EAN	IMBALLO	PREZZO € IVA ESCLUSA
8,5	60	E27	2700	806	-	-	120	1	SLD500952B	8031453018818	10	6,50
8,5	60	E27	4000	806	-	-	120	1	SLD500953B	8031453018825	10	6,50
8,5	60	E27	6500	806	-	-	120	1	SLD500951B	8031453018801	10	6,50





## REFLECTOR R80 220-240V

NEW

CATEGORIA SCONTO 21

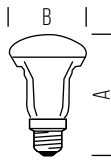

DIMENSIONI	A	B
1	114	80



POTENZA WATT	EQUIVALENZA WATT	BASE	KELVIN	LUMEN LM	LUMEN UTILI	CANDELE CD	FASCIO °	MISURE MM	CODICE	EAN	IMBALLO	PREZZO € IVA ESCLUSA
11,0	75	E27	2700	1055	-	-	120	1	SLD501252B	8031453018849	10	9,20
11,0	75	E27	4000	1055	-	-	120	1	SLD501253B	8031453018856	10	9,20
11,0	75	E27	6500	1055	-	-	120	1	SLD501251B	8031453018832	10	9,20



**LED GU10 220-240V**

NEW

CATEGORIA SCONTO 21

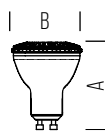

DIMENSIONI		A	B
1		54	50



POTENZA WATT	EQUIVALENZA WATT	BASE	KELVIN	LUMEN LM	LUMEN UTILI	CANDELE CD	FASCIO °	MISURE MM	CODICE	EAN	IMBALLO	PREZZO € IVA ESCLUSA
4,5	51	GU10	2700	380	355	780	36	1	<b>SLD630532B</b>	8031453018498	10	3,75
4,5	51	GU10	4000	380	355	780	36	1	<b>SLD630533B</b>	8031453018504	10	3,75
4,5	51	GU10	6500	380	355	780	36	1	<b>SLD630531B</b>	8031453018481	10	3,75

**LED GU10 220-240V**

NEW

CATEGORIA SCONTO 21

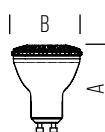

DIMENSIONI		A	B
1		54	50



POTENZA WATT	EQUIVALENZA WATT	BASE	KELVIN	LUMEN LM	LUMEN UTILI	CANDELE CD	FASCIO °	MISURE MM	CODICE	EAN	IMBALLO	PREZZO € IVA ESCLUSA
4,5	44	GU10	2700	370	300	310	60	1	<b>SLD630542B</b>	8031453018528	10	3,75
4,5	44	GU10	4000	370	300	310	60	1	<b>SLD630543B</b>	8031453018535	10	3,75
4,5	44	GU10	6500	370	300	310	60	1	<b>SLD630541B</b>	8031453018511	10	3,75

**LED GU10 220-240V DIMMERABILE**

AGGIORNATO

CATEGORIA SCONTO 21

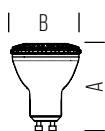

DIMENSIONI		A	B
1		54	50



POTENZA WATT	EQUIVALENZA WATT	BASE	KELVIN	LUMEN LM	LUMEN UTILI	CANDELE CD	FASCIO °	MISURE MM	CODICE	EAN	IMBALLO	PREZZO € IVA ESCLUSA
6,4	58	GU10	3000	550	410	420	60	1	<b>SLD630842D</b>	8031453013554	10	8,80
6,4	58	GU10	4000	550	410	420	60	1	<b>SLD630843D</b>	8031453018665	10	8,80

NEW

## LED GU10 220-240V

NEW

CATEGORIA SCONTO 21

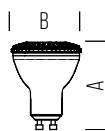

DIMENSIONI	A	B
1	54	50



POTENZA WATT	EQUIVALENZA WATT	BASE	KELVIN	LUMEN LM	LUMEN UTILI	CANDELE CD	FASCIO °	MISURE MM	CODICE	EAN	IMBALLO	PREZZO € IVA ESCLUSA
6,3	71	GU10	2700	570	505	1000	36	1	SLD630732B	8031453018559	10	4,90
6,3	71	GU10	4000	570	505	1000	36	1	SLD630733B	8031453018566	10	4,90
6,3	71	GU10	6500	570	505	1000	36	1	SLD630731B	8031453018542	10	4,90

## LED GU10 220-240V

NEW

CATEGORIA SCONTO 21

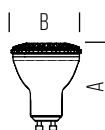

DIMENSIONI	A	B
1	54	50



POTENZA WATT	EQUIVALENZA WATT	BASE	KELVIN	LUMEN LM	LUMEN UTILI	CANDELE CD	FASCIO °	MISURE MM	CODICE	EAN	IMBALLO	PREZZO € IVA ESCLUSA
6,3	61	GU10	2700	560	430	405	60	1	SLD630742B	8031453018580	10	4,90
6,3	61	GU10	4000	560	430	405	60	1	SLD630743B	8031453018597	10	4,90
6,3	61	GU10	6500	560	430	405	60	1	SLD630741B	8031453018573	10	4,90

## LED GU10 220-240V

NEW

CATEGORIA SCONTO 21

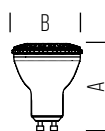

DIMENSIONI	A	B
1	54	50



POTENZA WATT	EQUIVALENZA WATT	BASE	KELVIN	LUMEN LM	LUMEN UTILI	CANDELE CD	FASCIO °	MISURE MM	CODICE	EAN	IMBALLO	PREZZO € IVA ESCLUSA
6,3	68	GU10	2700	550	480	240	100	1	SLD630752B	8031453018610	10	4,90
6,3	68	GU10	4000	550	480	240	100	1	SLD630753B	8031453018627	10	4,90
6,3	68	GU10	6500	550	480	240	100	1	SLD630751B	8031453018603	10	4,90

**LED GU10 220-240V ALL-GLASS**

CATEGORIA SCONTO 21

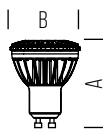

DIMENSIONI	A	B
1	54	50



POTENZA WATT	EQUIVALENZA WATT	BASE	KELVIN	LUMEN LM	LUMEN UTILI	CANDELE CD	FASCIO °	MISURE MM	CODICE	EAN	IMBALLO	PREZZO € IVA ESCLUSA
4,0	50	GU10	2700	400	345	610	36	1	SLD620432	8031453014872	10	4,70

**LED GU10 220-240V ALL-GLASS DIMMERABILE**

CATEGORIA SCONTO 21

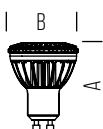

DIMENSIONI	A	B
1	54	50



POTENZA WATT	EQUIVALENZA WATT	BASE	KELVIN	LUMEN LM	LUMEN UTILI	CANDELE CD	FASCIO °	MISURE MM	CODICE	EAN	IMBALLO	PREZZO € IVA ESCLUSA
4,5	50	GU10	2700	405	345	680	36	1	SLD620432D	8031453014902	10	7,90

## LED GU10 220-240V

AGGIORNATO

CATEGORIA SCONTO 21

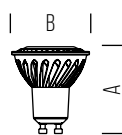

DIMENSIONI	A	B
1	54	50



POTENZA WATT	EQUIVALENZA WATT	BASE	KELVIN	LUMEN LM	LUMEN UTILI	CANDELE CD	FASCIO °	MISURE MM	CODICE	EAN	IMBALLO	PREZZO € IVA ESCLUSA
5,2	60	GU10	2700	450	425	920	36	1	SLD600732	8031453010546	10	9,00
5,2	62	GU10	4000	480	440	930	36	1	SLD600733	8031453011086	10	9,00
5,2	62	GU10	6500	480	440	930	36	1	SLD600731	8031453010515	10	9,00

## LED GU10 220-240V DIMMERABILE

CATEGORIA SCONTO 21

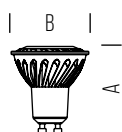

DIMENSIONI	A	B
1	54	50



POTENZA WATT	EQUIVALENZA WATT	BASE	KELVIN	LUMEN LM	LUMEN UTILI	CANDELE CD	FASCIO °	MISURE MM	CODICE	EAN	IMBALLO	PREZZO € IVA ESCLUSA
6,5	58	GU10	2700	430	405	1050	36	1	SLD600732D	8031453012205	10	17,30

**LED MR16 AC/DC 12V**
**NEW**

CATEGORIA SCONTO 21

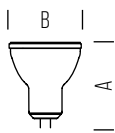

DIMENSIONI	A	B
1	45	50



POTENZA WATT	EQUIVALENZA WATT	BASE	KELVIN	LUMEN LM	LUMEN UTILI	CANDELE CD	FASCIO °	MISURE MM	CODICE	EAN	IMBALLO	PREZZO € IVA ESCLUSA
6,3	45	GU5.3	2700	560	520	450	60	1	<b>SLD650742B</b>	8031453018641	10	6,75
6,3	45	GU5.3	4000	560	520	450	60	1	<b>SLD650743B</b>	8031453018658	10	6,75
6,3	45	GU5.3	6500	560	520	450	60	1	<b>SLD650741B</b>	8031453018634	10	6,75

Si consiglia l'uso di alimentatori led in DC o trasformatori ferromagnetici. Nel caso di trasformatori elettronici in AC verificare il corretto funzionamento ed i valori di corrente e tensione.

**LED MR16 AC/DC 12V**
**AGGIORNATO**

CATEGORIA SCONTO 21

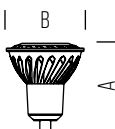

DIMENSIONI	A	B
1	45	50



POTENZA WATT	EQUIVALENZA WATT	BASE	KELVIN	LUMEN LM	LUMEN UTILI	CANDELE CD	FASCIO °	MISURE MM	CODICE	EAN	IMBALLO	PREZZO € IVA ESCLUSA
5,5	40	GU5.3	2700	480	440	950	36	1	<b>SLD640632</b>	8031453013615	10	10,70
5,5	41	GU5.3	5000	500	450	960	36	1	<b>SLD640631</b>	8031453013585	10	10,70

Si consiglia l'uso di alimentatori led in DC o trasformatori ferromagnetici. Nel caso di trasformatori elettronici in AC verificare il corretto funzionamento ed i valori di corrente e tensione.

## LED MR11 AC/DC 12V

CATEGORIA SCONTO 21

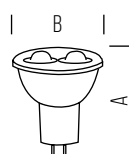

DIMENSIONI	A	B
1	40	35



POTENZA WATT	EQUIVALENZA WATT	BASE	KELVIN	LUMEN LM	LUMEN UTILI	CANDELE CD	FASCIO °	MISURE MM	CODICE	EAN	IMBALLO	PREZZO € IVA ESCLUSA
2,0	-	GU4	2700	140	120	290	36	1	LD290232B	8031453008291	10	5,35

Si consiglia l'uso di alimentatori led in DC o trasformatori ferromagnetici. Nel caso di trasformatori elettronici in AC verificare il corretto funzionamento ed i valori di corrente e tensione.

## LED MR11 AC/DC 12V

NEW

CATEGORIA SCONTO 21

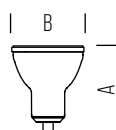

DIMENSIONI	A	B
1	40	34



POTENZA WATT	EQUIVALENZA WATT	BASE	KELVIN	LUMEN LM	LUMEN UTILI	CANDELE CD	FASCIO °	MISURE MM	CODICE	EAN	IMBALLO	PREZZO € IVA ESCLUSA
2,6	-	GU4	2700	230	210	500	36	1	SLD660332	8031453017538	10	5,35

Si consiglia l'uso di alimentatori led in DC o trasformatori ferromagnetici. Nel caso di trasformatori elettronici in AC verificare il corretto funzionamento ed i valori di corrente e tensione.

### LED G9 220-240V

NEW

CATEGORIA SCONTO 21

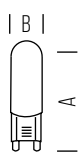

DIMENSIONI		A	B
1		48	16



POTENZA WATT	EQUIVALENZA WATT	BASE	KELVIN	LUMEN LM	LUMEN UTILI	CANDELE CD	FASCIO °	MISURE MM	CODICE	EAN	IMBALLO	PREZZO € IVA ESCLUSA
2,3	21	G9	2700	200	-	-	300	1	SLD8302X2	8031453015442	10	6,70

### LED G9 220-240V

NEW

CATEGORIA SCONTO 21

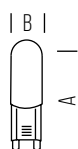

DIMENSIONI		A	B
1		49	14,5



POTENZA WATT	EQUIVALENZA WATT	BASE	KELVIN	LUMEN LM	LUMEN UTILI	CANDELE CD	FASCIO °	MISURE MM	CODICE	EAN	IMBALLO	PREZZO € IVA ESCLUSA
3,0	27	G9	3000	280	-	-	300	1	SLD8403X2	8031453015534	10	11,10

### LED G9 220-240V

NEW

CATEGORIA SCONTO 21

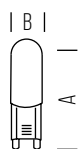

DIMENSIONI		A	B
1		54	17



POTENZA WATT	EQUIVALENZA WATT	BASE	KELVIN	LUMEN LM	LUMEN UTILI	CANDELE CD	FASCIO °	MISURE MM	CODICE	EAN	IMBALLO	PREZZO € IVA ESCLUSA
4,0	35	G9	3000	400	-	-	300	2	SLD8504X2	8031453015565	10	10,85



## LED BISPINA G4 AC/DC 12V

NEW

CATEGORIA SCONTO 21

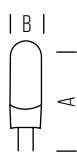

DIMENSIONI		A	B
1		37,5	9,7



POTENZA WATT	EQUIVALENZA WATT	BASE	KELVIN	LUMEN LM	LUMEN UTILI	CANDELE CD	FASCIO °	MISURE MM	CODICE	EAN	IMBALLO	PREZZO € IVA ESCLUSA
1,0	-	G4	2700	100	-	-	360	1	SLD8601X2	8031453017385	10	6,00
1,0	-	G4	4000	110	-	-	360	1	SLD8601X3	8031453017408	10	6,00

Si consiglia l'uso di alimentatori led in DC o trasformatori ferromagnetici. Nel caso di trasformatori elettronici in AC verificare il corretto funzionamento ed i valori di corrente e tensione.

## LED BISPINA G4 AC/DC 12V

NEW

CATEGORIA SCONTO 21

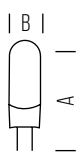

DIMENSIONI		A	B
1		46	13



POTENZA WATT	EQUIVALENZA WATT	BASE	KELVIN	LUMEN LM	LUMEN UTILI	CANDELE CD	FASCIO °	MISURE MM	CODICE	EAN	IMBALLO	PREZZO € IVA ESCLUSA
2,5	25	G4	2700	250	-	-	360	1	SLD8603X2	8031453017422	10	7,45
2,5	26	G4	4000	260	-	-	360	1	SLD8603X3	8031453017521	10	7,45

Si consiglia l'uso di alimentatori led in DC o trasformatori ferromagnetici. Nel caso di trasformatori elettronici in AC verificare il corretto funzionamento ed i valori di corrente e tensione.

## LED BISPINA G4 AC/DC 12V SATINATA

CATEGORIA SCONTO 21

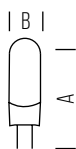

DIMENSIONI		A	B
1		36	10



POTENZA WATT	EQUIVALENZA WATT	BASE	KELVIN	LUMEN LM	LUMEN UTILI	CANDELE CD	FASCIO °	MISURE MM	CODICE	EAN	IMBALLO	PREZZO € IVA ESCLUSA
1,5	19	G4	2700	180	-	-	360	1	SLD8202X2	8031453012564	10	9,65
1,5	20	G4	4000	190	-	-	360	1	SLD8202X3	8031453014933	10	9,65

Si consiglia l'uso di alimentatori led in DC o trasformatori ferromagnetici. Nel caso di trasformatori elettronici in AC verificare il corretto funzionamento ed i valori di corrente e tensione.



### LED LINEARI R7S 220-240V

NEW  
CATEGORIA SCONTO 21

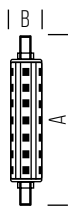

DIMENSIONI	A	B
1	78	25
2	118	25



POTENZA WATT	EQUIVALENZA WATT	BASE	KELVIN	LUMEN LM	LUMEN UTILI	CANDELE CD	FASCIO °	MISURE MM	CODICE	EAN	IMBALLO	PREZZO € IVA ESCLUSA
5,2	-	R7S	3000	600	-	-	360	1	<b>SLD9506X2</b>	8031453017620	10	8,00
9,5	-	R7S	3000	1200	-	-	360	2	<b>SLD9509X2</b>	8031453017651	10	15,30

### LED LINEARI R7S 220-240V

NEW  
CATEGORIA SCONTO 21

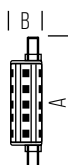

DIMENSIONI	A	B
1	78	29



POTENZA WATT	EQUIVALENZA WATT	BASE	KELVIN	LUMEN LM	LUMEN UTILI	CANDELE CD	FASCIO °	MISURE MM	CODICE	EAN	IMBALLO	PREZZO € IVA ESCLUSA
8,0	-	R7S	3000	1055	-	-	360	1	<b>SLD9610X2</b>	8031453019150	10	13,70



### LED LINEARI R7S 220-240V DIMMERABILE

NEW  
CATEGORIA SCONTO 21

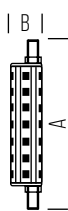

DIMENSIONI	A	B
1	118	29



POTENZA WATT	EQUIVALENZA WATT	BASE	KELVIN	LUMEN LM	LUMEN UTILI	CANDELE CD	FASCIO °	MISURE MM	CODICE	EAN	IMBALLO	PREZZO € IVA ESCLUSA
15,0	-	R7S	3000	2000	-	-	360	1	<b>SLD9716X2D</b>	8031453019167	10	28,70



## LT TUBO LED VETRO CON FILM DI PROTEZIONE T8 220-240V

AGGIORNATO

CATEGORIA SCONTO 21

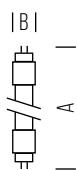

DIMENSIONI	A	B
1	600	26
2	900	26
3	1200	26
4	1500	26



POTENZA WATT	EQUIVALENZA WATT	BASE	KELVIN	LUMEN LM	LUMEN UTILI	CANDELE CD	FASCIO °	MISURE MM	CODICE	EAN	IMBALLO	PREZZO € IVA ESCLUSA
9,0	18	G13	4000	900	-	-	200	1	LT06093B	8031453009427	10	8,40
9,0	18	G13	6500	900	-	-	200	1	LT06091B	8031453009403	10	8,40
<b>NEW</b>	13,0	30	G13	4000	1300	-	220	2	LT09133B	8031453015398	10	9,60
<b>NEW</b>	13,0	30	G13	6500	1300	-	220	2	LT09131B	8031453015381	10	9,60
18,0	36	G13	4000	1800	-	-	200	3	LT12183B	8031453009465	10	11,10
18,0	36	G13	6500	1800	-	-	200	3	LT12181B	8031453009441	10	11,10
22,0	58	G13	4000	2200	-	-	200	4	LT15223B	8031453009571	10	15,00
22,0	58	G13	6500	2200	-	-	200	4	LT15221B	8031453009489	10	15,00



## LT TUBO LED POLICARBONATO T8 220-240V

CATEGORIA SCONTO 21

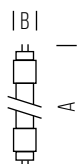

DIMENSIONI	A	B
1	600	26
2	1200	26
3	1500	26



POTENZA WATT	EQUIVALENZA WATT	BASE	KELVIN	LUMEN LM	LUMEN UTILI	CANDELE CD	FASCIO °	MISURE MM	CODICE	EAN	IMBALLO	PREZZO € IVA ESCLUSA
9,0	18,0	G13	4000	900	-	-	180	1	LT06093G	8031453007096	10	15,00
9,0	18,0	G13	6500	900	-	-	180	1	LT06091G	8031453007065	10	15,00
18,0	36,0	G13	4000	1800	-	-	180	2	LT12183G	8031453007157	10	23,00
18,0	36,0	G13	6500	1800	-	-	180	2	LT12181G	8031453007126	10	23,00
22,0	58,0	G13	4000	2200	-	-	180	3	LT15223G	8031453007218	10	28,00
22,0	58,0	G13	6500	2200	-	-	180	3	LT15221G	8031453007188	10	28,00



## STARTER PER TUBI A LED

CATEGORIA SCONTO 21

CODICE	EAN	IMBALLO	PREZZO € IVA ESCLUSA
LTSTU	8031453011635	25	1,70

**PL ALC LED 220-240V**

CATEGORIA SCONTO 21

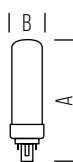

DIMENSIONI	A	B
1	150	45



POTENZA WATT	EQUIVALENZA WATT	BASE	KELVIN	LUMEN LM	LUMEN UTILI	CANDELE CD	FASCIO °	MISURE MM	CODICE	EAN	IMBALLO	PREZZO € IVA ESCLUSA
9,0	-	G24D-2	3000	750	-	-	150	1	<b>LD661052</b>	8031453006693	10	12,50
9,0	-	G24D-2	4000	800	-	-	150	1	<b>LD661053</b>	8031453006723	10	12,50
11,0	-	G24D-3	3000	1000	-	-	150	1	<b>LD661252</b>	8031453006754	10	13,20
11,0	-	G24D-3	4000	1050	-	-	150	1	<b>LD661253</b>	8031453006785	10	13,20

**LED AR111 AC/DC 12V**

AGGIORNATO

CATEGORIA SCONTO 21

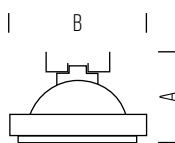

DIMENSIONI	A	B
1	54	111



POTENZA WATT	EQUIVALENZA WATT	BASE	KELVIN	LUMEN LM	LUMEN UTILI	CANDELE CD	FASCIO °	MISURE MM	CODICE	EAN	IMBALLO	PREZZO € IVA ESCLUSA
11,0	77	G53	3000	850	750	2400	25	1	<b>SLD571122</b>	8031453013318	20	18,20
<b>NEW</b> 11,0	71	G53	3000	800	710	1060	40	1	<b>SLD571132</b>	8031453015404	20	18,20

\* Si consiglia l'uso di alimentatori led in DC o trasformatori ferromagnetici. Nel caso di trasformatori elettronici in AC verificare il corretto funzionamento ed i valori di corrente e tensione.

**LED AR111 100-240V**

NEW

CATEGORIA SCONTO 21

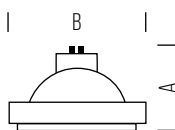

DIMENSIONI	A	B
1	56	111



POTENZA WATT	EQUIVALENZA WATT	BASE	KELVIN	LUMEN LM	LUMEN UTILI	CANDELE CD	FASCIO °	MISURE MM	CODICE	EAN	IMBALLO	PREZZO € IVA ESCLUSA
10,5	77	GU10	3000	850	750	2400	25	1	<b>SLD5711226</b>	8031453013332	20	14,60

## LED PAR30 100-240V

CATEGORIA SCONTO 21

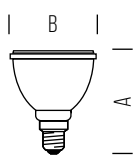

DIMENSIONI	A	B
1	90	95



POTENZA WATT	EQUIVALENZA WATT	BASE	KELVIN	LUMEN LM	LUMEN UTILI	CANDELE CD	FASCIO °	MISURE MM	CODICE	EAN	IMBALLO	PREZZO € IVA ESCLUSA
10,0	98	E27	3000	940	840	3000	25	1	SLD551022	8031453012694	25	13,60

## LED PAR38 100-240V

CATEGORIA SCONTO 21

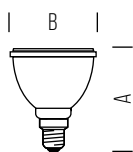

DIMENSIONI	A	B
1	136	121



POTENZA WATT	EQUIVALENZA WATT	BASE	KELVIN	LUMEN LM	LUMEN UTILI	CANDELE CD	FASCIO °	MISURE MM	CODICE	EAN	IMBALLO	PREZZO € IVA ESCLUSA
10,0	103	E27	3000	1000	900	3400	25	1	SLD561022	8031453013295	10	15,50
14,0	120	E27	3000	1400	1260	4000	25	1	SLD561422	8031453014285	10	16,00

## LED PAR38 100-240V WATERPROOF IP65

NEW  
CATEGORIA SCONTO 21

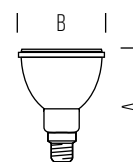

DIMENSIONI	A	B
1	136	121



POTENZA WATT	EQUIVALENZA WATT	BASE	KELVIN	LUMEN LM	LUMEN UTILI	CANDELE CD	FASCIO °	MISURE MM	CODICE	EAN	IMBALLO	PREZZO € IVA ESCLUSA
14,0	120	E27	3000	1300	1170	2800	25	1	SLD561422WPF	8031453017569	4	18,00

### LED LINEARLINE 300MM 220-240V

CATEGORIA SCONTO 21

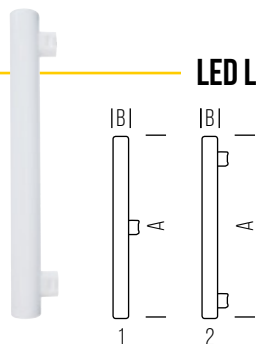

DIMENSIONI	A	B
1	300	30
2	300	30



POTENZA WATT	EQUIVALENZA WATT	BASE	KELVIN	LUMEN LM	LUMEN UTILI	CANDELE CD	FASCIO °	MISURE MM	CODICE	EAN	IMBALLO	PREZZO € IVA ESCLUSA
5,0	32	S14D	2700	350	-	-	200	1	SLD9005X2	8031453011659	10	12,90
5,0	32	S14S	2700	350	-	-	200	2	SLD9105X2	8031453011710	10	12,90

### LED LINEARLINE 600MM 220-240V

CATEGORIA SCONTO 21

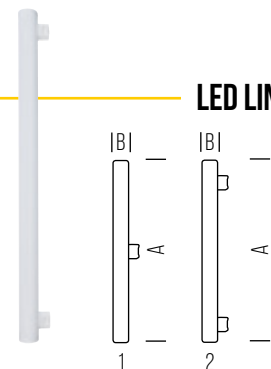

DIMENSIONI	A	B
1	500	30
2	500	30



POTENZA WATT	EQUIVALENZA WATT	BASE	KELVIN	LUMEN LM	LUMEN UTILI	CANDELE CD	FASCIO °	MISURE MM	CODICE	EAN	IMBALLO	PREZZO € IVA ESCLUSA
8,0	48	S14D	2700	600	-	-	200	1	SLD9008X2	8031453011680	10	15,20
8,0	48	S14S	2700	600	-	-	200	2	SLD9108X2	8031453011741	10	15,20

### LED LINEARLINE 1000MM 220-240V

NEW

CATEGORIA SCONTO 21

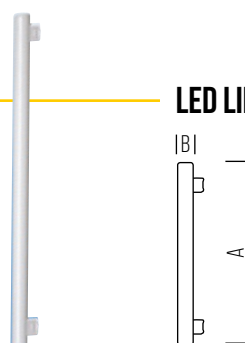

DIMENSIONI	A	B
1	1000	30



POTENZA WATT	EQUIVALENZA WATT	BASE	KELVIN	LUMEN LM	LUMEN UTILI	CANDELE CD	FASCIO °	MISURE MM	CODICE	EAN	IMBALLO	PREZZO € IVA ESCLUSA
14,0	77	S14S	2700	1100	-	-	200	1	SLD9114X2	8031453015602	30	30,10



## LED PLANT GOCCIA PER CRESCITA PIANTE 220-240V

CATEGORIA SCONTO 21

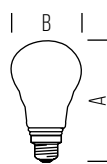

DIMENSIONI	A	B
1	115	60



POTENZA WATT	EQUIVALENZA WATT	BASE	KELVIN	LUMEN LM	LUMEN UTILI	CANDELE CD	FASCIO °	MISURE MM	CODICE	EAN	IMBALLO	PREZZO € IVA ESCLUSA
6,5	-	E27	-	-	-	-	-	1	4711354	6435200182777	10	39,00



## LED FROST GOCCIA PER CELLA FRIGORIFERA -40 C° 220-240V

CATEGORIA SCONTO 21

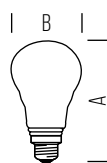

DIMENSIONI	A	B
1	104	55
2	112	60



POTENZA WATT	EQUIVALENZA WATT	BASE	KELVIN	LUMEN LM	LUMEN UTILI	CANDELE CD	FASCIO °	MISURE MM	CODICE	EAN	IMBALLO	PREZZO € IVA ESCLUSA
5,5	-	E27	2800	470	-	-	-	1	4711394	6435200192097	10	13,30
9,5	-	E27	4000	810	-	-	-	2	4711395	6435200192110	10	17,40



## LED SFERA 220-240V IP54

CATEGORIA SCONTO 21



DIMENSIONI	A	B
1	93	45



POTENZA WATT	EQUIVALENZA WATT	BASE	KELVIN	LUMEN LM	LUMEN UTILI	CANDELE CD	FASCIO °	MISURE MM	CODICE	EAN	IMBALLO	PREZZO € IVA ESCLUSA
5,0	-	E27	2800	400	-	-	-	1	4711356	6435200182814	10	18,70

**GOCCIA OPALE 220-240V**

AGGIORNATO

CATEGORIA SCONTO 21

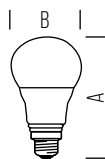

DIMENSIONI	A	B
1	110	60
2	120	60



POTENZA WATT	EQUIVALENZA WATT	BASE	KELVIN	LUMEN LM	LUMEN UTILI	CANDELE CD	FASCIO °	MISURE MM	CODICE	EAN	IMBALLO	PREZZO € IVA ESCLUSA
5,5	40	E27	2700	470	-	-	240	1	ELD1007X2	8031453008505	10	3,40
5,5	40	E27	6500	470	-	-	240	1	ELD1007X1	8031453008475	10	3,40
9,0	60	E27	2700	806	-	-	240	1	ELD1009X2	8031453009823	10	3,65
<b>NEW</b> 9,0	60	E27	4000	806	-	-	240	1	ELD1009X3	8031453017057	10	3,65
9,0	60	E27	6500	806	-	-	240	1	ELD1009X1	8031453009793	10	3,65
10,5	75	E27	2700	1060	-	-	240	1	ELD1012X2	8031453009885	10	4,60
<b>NEW</b> 10,5	75	E27	4000	1060	-	-	240	1	ELD1012X3	8031453017088	10	4,60
10,5	75	E27	6500	1060	-	-	240	1	ELD1012X1	8031453009854	10	4,60
14,0	100	E27	2700	1521	-	-	220	2	ELD1015X2	8031453014995	10	6,20
<b>NEW</b> 14,0	100	E27	4000	1521	-	-	220	2	ELD1015X3	8031453017118	10	6,20
14,0	100	E27	6500	1521	-	-	220	2	ELD1015X1	8031453014964	10	6,20

**GOCCIA OPALE 220-240V**

NEW

CATEGORIA SCONTO 21

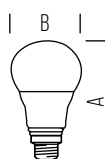

DIMENSIONI	A	B
1	143	67



POTENZA WATT	EQUIVALENZA WATT	BASE	KELVIN	LUMEN LM	LUMEN UTILI	CANDELE CD	FASCIO °	MISURE MM	CODICE	EAN	IMBALLO	PREZZO € IVA ESCLUSA
18,0	121	E27	2700	1921	-	-	230	1	ELD1018X2	8031453018122	10	11,40
18,0	121	E27	4000	1921	-	-	230	1	ELD1018X3	8031453018405	10	11,40
18,0	121	E27	6500	1921	-	-	230	1	ELD1018X1	8031453018092	10	11,40
20,0	150	E27	2700	2452	-	-	200	1	ELD1020X2	8031453018184	10	13,10
20,0	150	E27	4000	2452	-	-	200	1	ELD1020X3	8031453018436	10	13,10
20,0	150	E27	6500	2452	-	-	200	1	ELD1020X1	8031453018153	10	13,10





## SFERA OPALE 220-240V

AGGIORNATO

CATEGORIA SCONTO 21

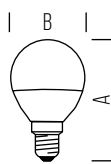

DIMENSIONI	A	B
1	78	45
2	86	45



POTENZA WATT	EQUIVALENZA WATT	BASE	KELVIN	LUMEN LM	LUMEN UTILI	CANDELE CD	FASCIO °	MISURE MM	CODICE	EAN	IMBALLO	PREZZO € IVA ESCLUSA
3,4	25	E14	2700	250	-	-	240	1	ELD3003X2	8031453010065	10	3,05
<b>NEW</b> 3,4	25	E14	4000	270	-	-	240	1	ELD3003X3	8031453017149	10	3,05
3,4	26	E14	6500	270	-	-	240	1	ELD3003X1	8031453010034	10	3,05
5,4	40	E14	2700	470	-	-	240	1	ELD3006X2	8031453010126	10	3,50
<b>NEW</b> 5,4	40	E14	4000	510	-	-	240	1	ELD3006X3	8031453017170	10	3,50
5,4	40	E14	6500	520	-	-	240	1	ELD3006X1	8031453010096	10	3,50
<b>NEW</b> 7,5	60	E14	2700	806	-	-	240	2	ELD3010X2	8031453019105	10	6,80
<b>NEW</b> 7,5	60	E14	4000	806	-	-	240	2	ELD3010X3	8031453019112	10	6,80
<b>NEW</b> 7,5	60	E14	6500	806	-	-	240	2	ELD3010X1	8031453019099	10	6,80

## SFERA OPALE 220-240V

AGGIORNATO

CATEGORIA SCONTO 21

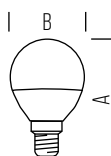

DIMENSIONI	A	B
1	74	45
2	84	45



POTENZA WATT	EQUIVALENZA WATT	BASE	KELVIN	LUMEN LM	LUMEN UTILI	CANDELE CD	FASCIO °	MISURE MM	CODICE	EAN	IMBALLO	PREZZO € IVA ESCLUSA
<b>NEW</b> 3,4	25	E27	2700	250	-	-	240	1	ELD3103X2	8031453018764	10	3,05
<b>NEW</b> 3,4	25	E27	4000	250	-	-	240	1	ELD3103X3	8031453018771	10	3,05
<b>NEW</b> 3,4	25	E27	6500	250	-	-	240	1	ELD3103X1	8031453018757	10	3,05
5,4	40	E27	2700	470	-	-	240	1	ELD3106X2	8031453010485	10	3,50
<b>NEW</b> 5,4	40	E27	4000	510	-	-	240	1	ELD3106X3	8031453017200	10	3,50
5,4	40	E27	6500	520	-	-	240	1	ELD3106X1	8031453010454	10	3,50
<b>NEW</b> 7,5	60	E27	2700	806	-	-	240	2	ELD3110X2	8031453019136	10	6,80
<b>NEW</b> 7,5	60	E27	4000	806	-	-	240	2	ELD3110X3	8031453019143	10	6,80
<b>NEW</b> 7,5	60	E27	6500	806	-	-	240	2	ELD3110X1	8031453019129	10	6,80



**OLIVA OPALE 220-240V**

AGGIORNATO

CATEGORIA SCONTO 21

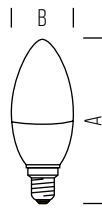

DIMENSIONI	A	B
1	102	35
2	105	35
3	110	38



POTENZA WATT	EQUIVALENZA WATT	BASE	KELVIN	LUMEN LM	LUMEN UTILI	CANDELE CD	FASCIO °	MISURE MM	CODICE	EAN	IMBALLO	PREZZO € IVA ESCLUSA
3,4	25	E14	2700	250	-	-	240	1	ELD2003X2	8031453009946	10	3,05
<b>NEW</b> 3,4	25	E14	4000	270	-	-	240	1	ELD2003X3	8031453017231	10	3,05
3,4	26	E14	6500	270	-	-	240	1	ELD2003X1	8031453009915	10	3,05
5,4	40	E14	2700	470	-	-	240	2	ELD2006X2	8031453010003	10	3,50
<b>NEW</b> 5,4	40	E14	4000	480	-	-	240	2	ELD2006X3	8031453017262	10	3,50
5,4	40	E14	6500	520	-	-	240	2	ELD2006X1	8031453009977	10	3,50
<b>NEW</b> 7,5	60	E14	2700	806	-	-	240	3	ELD2010X2	8031453019075	10	6,80
<b>NEW</b> 7,5	60	E14	4000	806	-	-	240	3	ELD2010X3	8031453019082	10	6,80
<b>NEW</b> 7,5	60	E14	6500	806	-	-	240	3	ELD2010X1	8031453019068	10	6,80



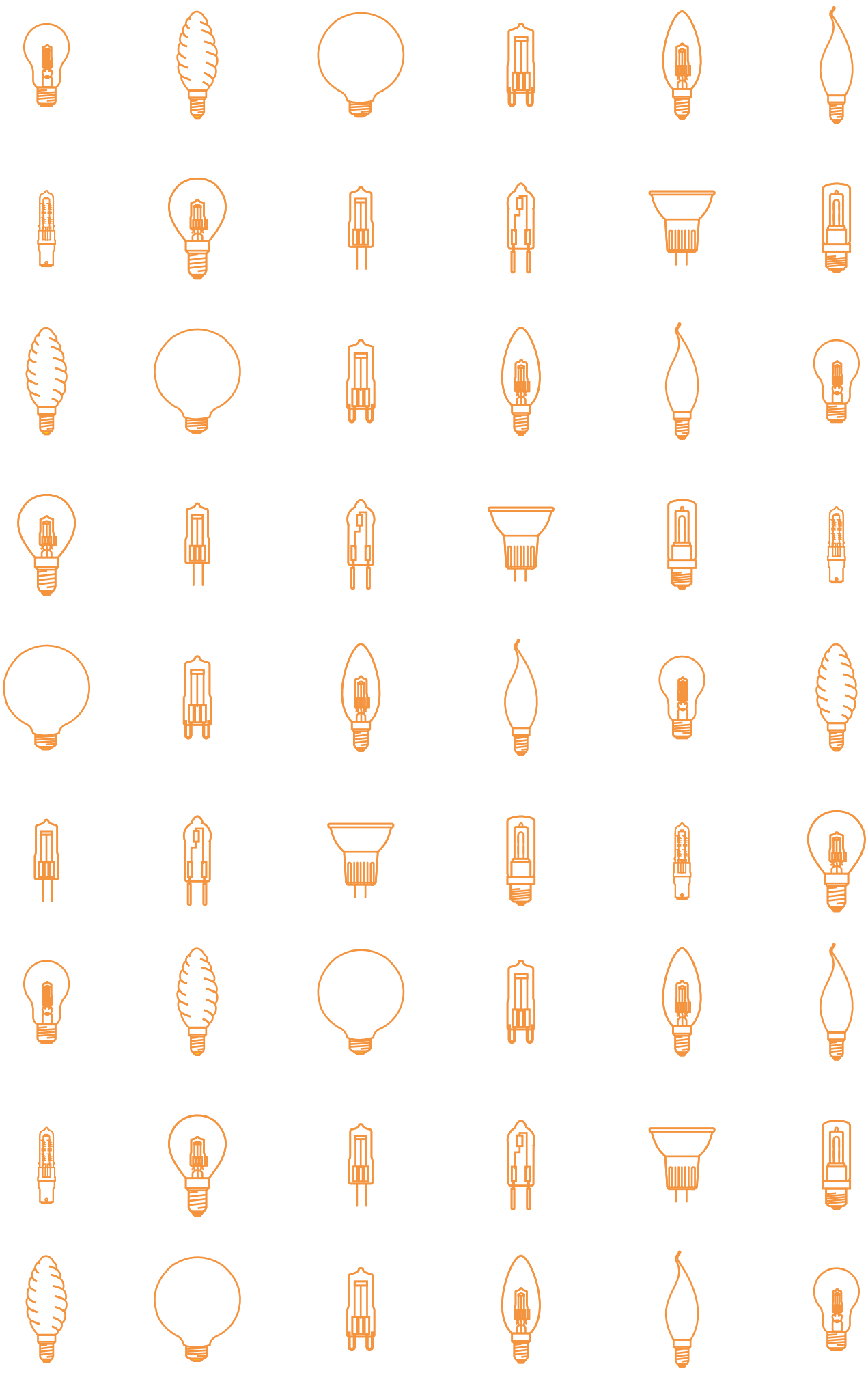



LAMPAD E ALOGENE

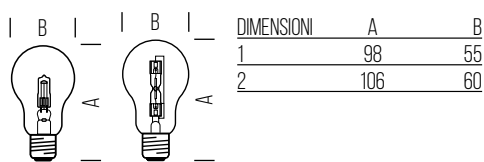

**GOCCIA CHIARA ENERGY SAVING 230V DIMMERABILE**

CATEGORIA SCONTO 8



POTENZA WATT	EQUIVALENZA WATT	BASE	KELVIN	LUMEN LM	LUMEN UTILI	CANDELE CD	FASCIO °	MISURE MM	CODICE	EAN	IMBALLO	PREZZO € IVA ESCLUSA
28	37	E27	2900	370	-	-	-	1	<b>G28H</b>	6435200150134	100	1,65
42	55	E27	2900	625	-	-	-	1	<b>G42H</b>	6435200015051	100	1,65
53	69	E27	2900	835	-	-	-	1	<b>G53H</b>	6435200015068	100	1,65
70	91	E27	2900	1180	-	-	-	1	<b>G70H</b>	6435200013453	100	1,65
105	142	E27	2900	2000	-	-	-	2	<b>G105H</b>	6435200013477	100	2,20
120	159	E27	2900	2300	-	-	-	2	<b>G120H</b>	6435200150158	100	2,20

**SFERA CHIARA ENERGY SAVING 230V DIMMERABILE**



CATEGORIA SCONTO 8



POTENZA WATT	EQUIVALENZA WATT	BASE	KELVIN	LUMEN LM	LUMEN UTILI	CANDELE CD	FASCIO °	MISURE MM	CODICE	EAN	IMBALLO	PREZZO € IVA ESCLUSA
18	24	E14	2900	205	-	-	-	1	<b>S18MH</b>	6435200150417	100	1,65
28	37	E14	2900	370	-	-	-	1	<b>S28MH</b>	6435200013507	100	1,65
42	55	E14	2900	625	-	-	-	1	<b>S42MH</b>	6435200013514	100	1,65
18	24	E27	2900	205	-	-	-	2	<b>S18H</b>	6435200150332	100	1,65
28	37	E27	2900	370	-	-	-	2	<b>S28H</b>	6435200014542	100	1,65
42	55	E27	2900	625	-	-	-	2	<b>S42H</b>	6435200014566	100	1,65

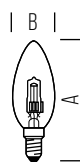

## OLIVA CHIARA ENERGY SAVING 230V DIMMERABILE



DIMENSIONI	A	B
1	100	35

CATEGORIA SCONTO 8



POTENZA WATT	EQUIVALENZA WATT	BASE	KELVIN	LUMEN LM	LUMEN UTILI	CANDELE CD	FASCIO °	MISURE MM	CODICE	EAN	IMBALLO	PREZZO € IVA ESCLUSA
18	24	E14	2900	205	-	-	-	1	018MH	6435200150448	100	1,65
28	37	E14	2900	370	-	-	-	1	028MH	6435200013484	100	1,65
42	55	E14	2900	625	-	-	-	1	042MH	6435200013491	100	1,65



## FIAMMA CHIARA ENERGY SAVING 230V DIMMERABILE



DIMENSIONI	A	B
1	124	35

CATEGORIA SCONTO 8



POTENZA WATT	EQUIVALENZA WATT	BASE	KELVIN	LUMEN LM	LUMEN UTILI	CANDELE CD	FASCIO °	MISURE MM	CODICE	EAN	IMBALLO	PREZZO € IVA ESCLUSA
28	37	E14	2900	370	-	-	-	1	F128MH	6435200014689	100	1,75
42	55	E14	2900	625	-	-	-	1	F142MH	6435200014702	100	1,75



## TORTIGLIONE CHIARA ENERGY SAVING 230V DIMMERABILE



DIMENSIONI	A	B
1	95	35

CATEGORIA SCONTO 8



POTENZA WATT	EQUIVALENZA WATT	BASE	KELVIN	LUMEN LM	LUMEN UTILI	CANDELE CD	FASCIO °	MISURE MM	CODICE	EAN	IMBALLO	PREZZO € IVA ESCLUSA
18	24	E14	2900	205	-	-	-	1	T18MH	6435200150554	100	1,65
28	37	E14	2900	370	-	-	-	1	T28MH	6435200150585	100	1,65
42	55	E14	2900	625	-	-	-	1	T42MH	6435200150615	100	1,65

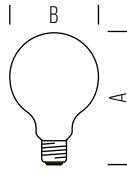

**GLOBO D126 CHIARA ENERGY SAVING 230V DIMMERABLE**

DIMENSIONI	A	B
1	165	125

CATEGORIA SCONTO 8

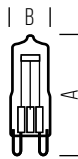

POTENZA WATT	EQUIVALENZA WATT	BASE	KELVIN	LUMEN LM	LUMEN UTILI	CANDELE CD	FASCIO °	MISURE MM	CODICE	EAN	IMBALLO	PREZZO € IVA ESCLUSA
18	24	E27	2900	205	-	-	-	1	<b>D12618H</b>	6435200169907	20	5,40
28	37	E27	2900	370	-	-	-	1	<b>D12628H</b>	6435200150905	20	5,40
42	55	E27	2900	625	-	-	-	1	<b>D12642H</b>	6435200150912	20	5,40
70	91	E27	2900	1180	-	-	-	1	<b>D12670H</b>	6435200150929	20	5,40



**HALONINE CHIARA ENERGY SAVING 230V DIMMERABLE**

DIMENSIONI	A	B
1	42	14

CATEGORIA SCONTO 8

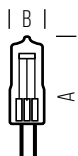

POTENZA WATT	EQUIVALENZA WATT	BASE	KELVIN	LUMEN LM	LUMEN UTILI	CANDELE CD	FASCIO °	MISURE MM	CODICE	EAN	IMBALLO	PREZZO € IVA ESCLUSA
18	25	G9	2900	205	-	-	-	1	<b>JCP18ES</b>	6435200015570	100	1,99
33	40	G9	2900	460	-	-	-	1	<b>JCP33ES</b>	6435200015563	100	1,99
48	60	G9	2900	740	-	-	-	1	<b>JCP48ES</b>	6435200015556	100	1,99

**BISPINA CHIARA ENERGY SAVING 12V DIMMERABLE**

DIMENSIONI	A	B
1	31	8
2	41	10

CATEGORIA SCONTO 8



POTENZA WATT	EQUIVALENZA WATT	BASE	KELVIN	LUMEN LM	LUMEN UTILI	CANDELE CD	FASCIO °	MISURE MM	CODICE	EAN	IMBALLO	PREZZO € IVA ESCLUSA
16	28	G4	2900	260	-	-	-	1	<b>JC16G4ES</b>	6435200153562	20	0,75
28	49	GY6,35	2900	540	-	-	-	2	<b>JC28GY635ES</b>	6435200153579	20	0,75
40	70	GY6,35	2900	850	-	-	-	2	<b>JC40GY635ES</b>	6435200153586	20	0,75





## LINEARI ENERGY SAVING R7S 230V DIMMERABILE

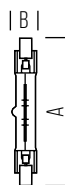

DIMENSIONI	A	B
1	79	9
2	119	9

CATEGORIA SCONTO 8



POTENZA WATT	EQUIVALENZA WATT	BASE	KELVIN	LUMEN LM	LUMEN UTILI	CANDELE CD	FASCIO °	MISURE MM	CODICE	EAN	IMBALLO	PREZZO € IVA ESCLUSA
80	100	R7S	2900	1380	-	-	-	1	<b>J8079ES</b>	6435200013873	100	2,60
120	150	R7S	2900	2250	-	-	-	1	<b>J12079ES</b>	6435200013323	100	2,60
80	100	R7S	2900	1380	-	-	-	2	<b>J80ES</b>	6435200015075	100	2,60
120	150	R7S	2900	2250	-	-	-	2	<b>J120ES</b>	6435200013835	100	2,60
160	200	R7S	2900	3100	-	-	-	2	<b>J160ES</b>	6435200013859	100	2,60
230	300	R7S	2900	4900	-	-	-	2	<b>J230ES</b>	6435200013347	100	2,60
400	500	R7S	2900	8600	-	-	-	2	<b>J400ES</b>	6435200013361	100	2,60



## TUBOLARI ENERGY SAVING 230V DIMMERABILE

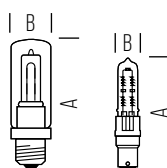

DIMENSIONI	A	B
1	105	32
2	86	13
3	98	15

CATEGORIA SCONTO 8



POTENZA WATT	EQUIVALENZA WATT	BASE	KELVIN	LUMEN LM	LUMEN UTILI	CANDELE CD	FASCIO °	MISURE MM	CODICE	EAN	IMBALLO	PREZZO € IVA ESCLUSA
70	91	E27	2900	1180	-	-	-	1	<b>JDD70ES</b>	-	12	14,90
100	129	E27	3000	1800	-	-	-	1	<b>JDD100ES</b>	-	12	14,90
150	192	E27	3000	2870	-	-	-	1	<b>JDD150ES</b>	-	12	14,90
205	250	E27	3000	4200	-	-	-	1	<b>JDD205ES</b>	-	12	14,90
70	91	B15D	3000	1180	-	-	-	2	<b>JD70B15ES</b>	-	12	14,90
100	129	B15D	3000	1800	-	-	-	2	<b>JD100B15ES</b>	-	12	14,90
150	192	B15D	3000	2870	-	-	-	2	<b>JD150B15ES</b>	-	12	14,90
205	250	B15D	3000	4200	-	-	-	3	<b>JD205B15ES</b>	-	12	14,90

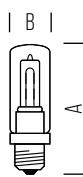

**TUBOLARE ENERGY SAVING 230V DIMMERABILE**

DIMENSIONI	A	B
1	80	25
2	96	28

CATEGORIA SCONTO 8

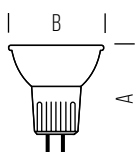

POTENZA WATT	EQUIVALENZA WATT	BASE	KELVIN	LUMEN LM	LUMEN UTILI	CANDELE CD	FASCIO °	MISURE MM	CODICE	EAN	IMBALLO	PREZZO € IVA ESCLUSA
28	37	E14	2900	370	-	-	-	1	<b>TB28M2580H</b>	6435200153432	50	2,00
28	37	E14	2900	370	-	-	-	2	<b>TB28M2896H</b>	6435200153463	50	2,20

**DICROICA CON VETRO ENERGY SAVING 12V DIMMERABILE**

DIMENSIONI	A	B
1	46	50

CATEGORIA SCONTO 8

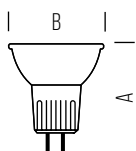

POTENZA WATT	EQUIVALENZA WATT	BASE	KELVIN	LUMEN LM	LUMEN UTILI	CANDELE CD	FASCIO °	MISURE MM	CODICE	EAN	IMBALLO	PREZZO € IVA ESCLUSA
16	-	GU5.3	2900	170	148	400	36	1	<b>16BABFGES</b>	6435200153616	10	1,30
28	36	GU5.3	2900	355	320	800	36	1	<b>28FMWFGES</b>	6435200153623	10	1,30
40	50	GU5.3	2900	600	540	1200	36	1	<b>40EXNFGES</b>	6435200153630	10	1,30

**DICROICA MR11 ENERGY SAVING 12V DIMMERABILE**

DIMENSIONI	A	B
1	34	35

CATEGORIA SCONTO 8



POTENZA WATT	EQUIVALENZA WATT	BASE	KELVIN	LUMEN LM	LUMEN UTILI	CANDELE CD	FASCIO °	MISURE MM	CODICE	EAN	IMBALLO	PREZZO € IVA ESCLUSA
16	-	GU4	2900	165	150	400	30	1	<b>16FTDFGES</b>	6435200169761	10	1,30
28	35	GU4	2900	355	320	700	30	1	<b>28FTHFGES</b>	6435200169792	10	1,30



## LINEARI 230V DIMMERABILE

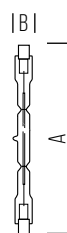

DIMENSIONI	A	B
1	191	12

CATEGORIA SCONTO 8



POTENZA WATT	EQUIVALENZA WATT	BASE	KELVIN	LUMEN LM	LUMEN UTILI	CANDELE CD	FASCIO °	MISURE MM	CODICE	EAN	IMBALLO	PREZZO € IVA ESCLUSA
1000	-	R7S	2900	22000	-	-	-	1	J1000	6435200012319	25	2,90



## BISPINA CHIARA 12V DIMMERABILE

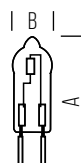

DIMENSIONI	A	B
1	31	8

CATEGORIA SCONTO 8



POTENZA WATT	EQUIVALENZA WATT	BASE	KELVIN	LUMEN LM	LUMEN UTILI	CANDELE CD	FASCIO °	MISURE MM	CODICE	EAN	IMBALLO	PREZZO € IVA ESCLUSA
5	-	G4	2900	50	-	-	-	1	JC564	6435200118189	20	0,83
10	-	G4	2900	100	-	-	-	1	JC1064	6435200011428	20	0,73

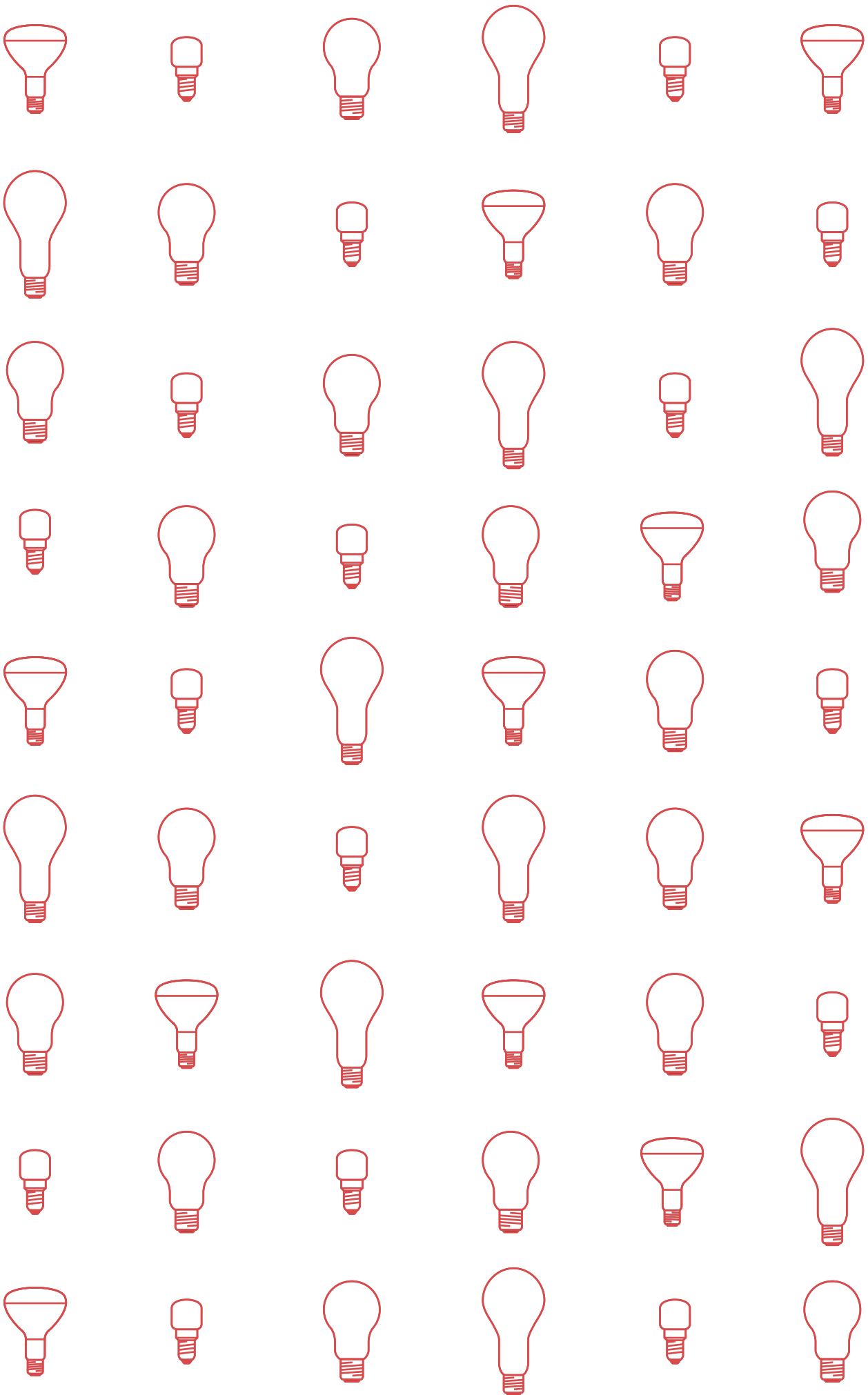



LAMPADE A **INCANDESCENZA**

**GOCCIA CHIARA 24V**

CATEGORIA SCONTO 2

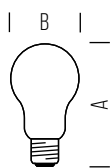

DIMENSIONI	A	B
1	107	60



POTENZA WATT	EQUIVALENZA WATT	BASE	KELVIN	LUMEN LM	LUMEN UTILI	CANDELE CD	FASCIO °	MISURE MM	CODICE	EAN	IMBALLO	PREZZO € IVA ESCLUSA
40	-	E27	2700	580	-	-	-	1	<b>G4024</b>	-	100	2,30
60	-	E27	2700	930	-	-	-	1	<b>G6024</b>	6435200007742	100	2,30
100	-	E27	2700	1740	-	-	-	1	<b>G10024</b>	-	100	2,30

**PICCOLA PERA CHIARA 230V**

CATEGORIA SCONTO 2

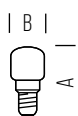

DIMENSIONI	A	B
1	57	25



POTENZA WATT	EQUIVALENZA WATT	BASE	KELVIN	LUMEN LM	LUMEN UTILI	CANDELE CD	FASCIO °	MISURE MM	CODICE	EAN	IMBALLO	PREZZO € IVA ESCLUSA
10	-	E14	2700	55	-	-	-	1	<b>PP05CM</b>	6435200007285	50	1,90

**PICCOLA PERA CHIARA PER FORNI 300° 230V**

CATEGORIA SCONTO 2

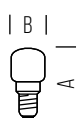

DIMENSIONI	A	B
1	48	22
2	55	25



POTENZA WATT	EQUIVALENZA WATT	BASE	KELVIN	LUMEN LM	LUMEN UTILI	CANDELE CD	FASCIO °	MISURE MM	CODICE	EAN	IMBALLO	PREZZO € IVA ESCLUSA
15	-	E14	2700	100	-	-	-	1	<b>PP15MFF240</b>	6435200007292	50	2,20
25	-	E14	2700	160	-	-	-	2	<b>PP25MFF</b>	6435200153425	50	2,20



## PICCOLA PERA CHIARA PER FRIGORIFERI 240V

CATEGORIA SCONTO 2

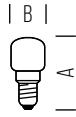

DIMENSIONI		A	B
1		58	26



POTENZA WATT	EQUIVALENZA WATT	BASE	KELVIN	LUMEN LM	LUMEN UTILI	CANDELE CD	FASCIO °	MISURE MM	CODICE	EAN	IMBALLO	PREZZO € IVA ESCLUSA
15	-	E14	2700	100	-	-	-	1	PP15MFR240	6435200007308	50	2,20



## GOCCIA PESCA 27V

CATEGORIA SCONTO 2

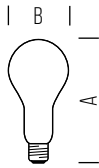

DIMENSIONI		A	B
1		233	110

- Lampada ad incandescenza a forma di goccia specifica per pesca.
- In apparecchi appositamente attrezzati aumenta notevolmente la cattura del pesce grazie all'elevato flusso luminoso.



POTENZA WATT	EQUIVALENZA WATT	BASE	KELVIN	LUMEN LM	LUMEN UTILI	CANDELE CD	FASCIO °	MISURE MM	CODICE	EAN	IMBALLO	PREZZO € IVA ESCLUSA
500	-	E40	2700	8200	-	-	-	1	G50024	8421389675108	20	41,00



## SPOT RAGGI INFRAROSSI 230V

CATEGORIA SCONTO 2

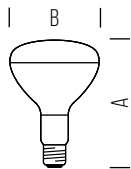

DIMENSIONI		A	B
1		175	125



POTENZA WATT	EQUIVALENZA WATT	BASE	KELVIN	LUMEN LM	LUMEN UTILI	CANDELE CD	FASCIO °	MISURE MM	CODICE	EAN	IMBALLO	PREZZO € IVA ESCLUSA
150	-	E27	IR	-	-	-	-	1	R1150	-	10	25,50
250	-	E27	IR	-	-	-	-	1	R1250	-	10	27,50

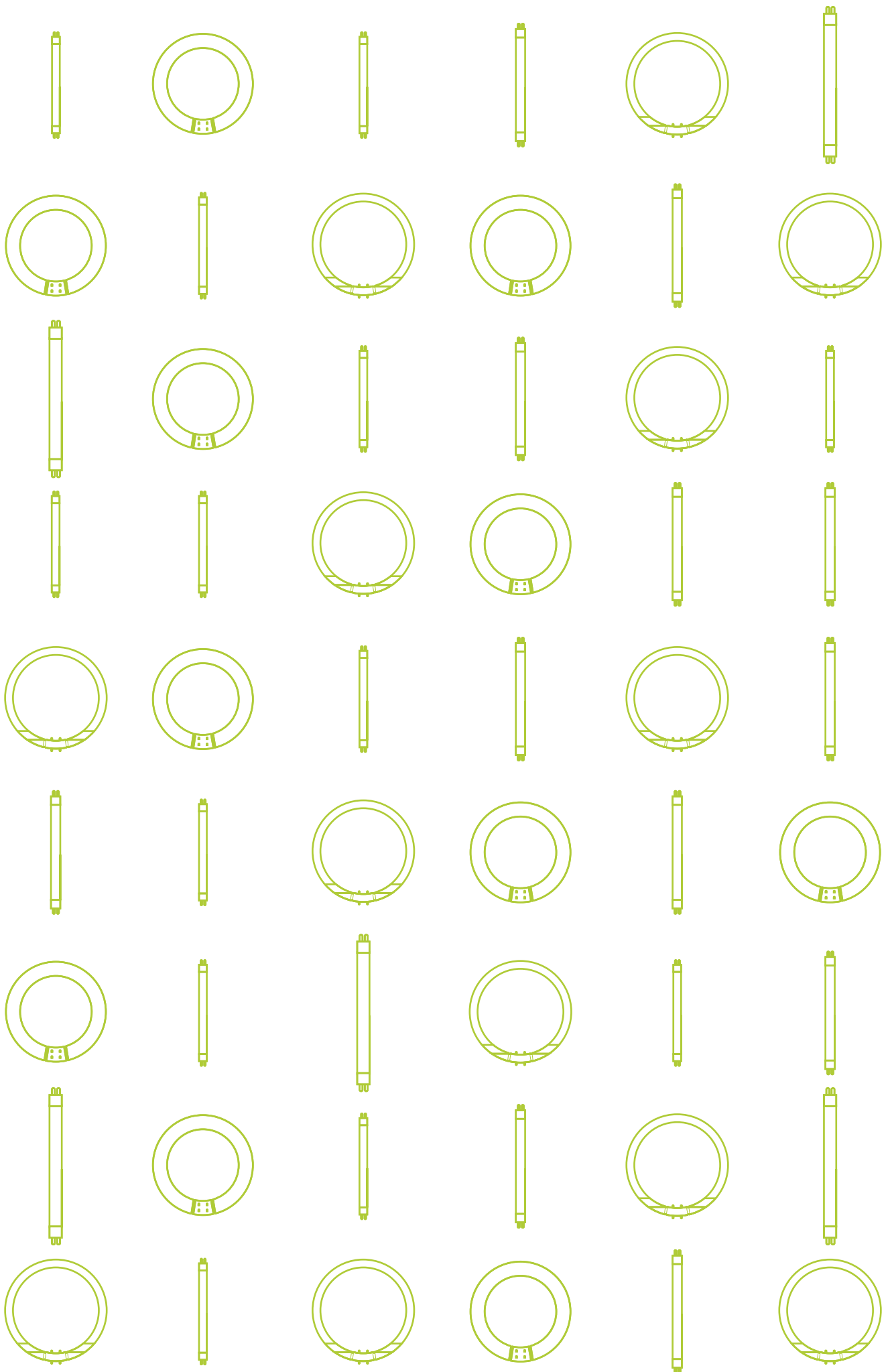



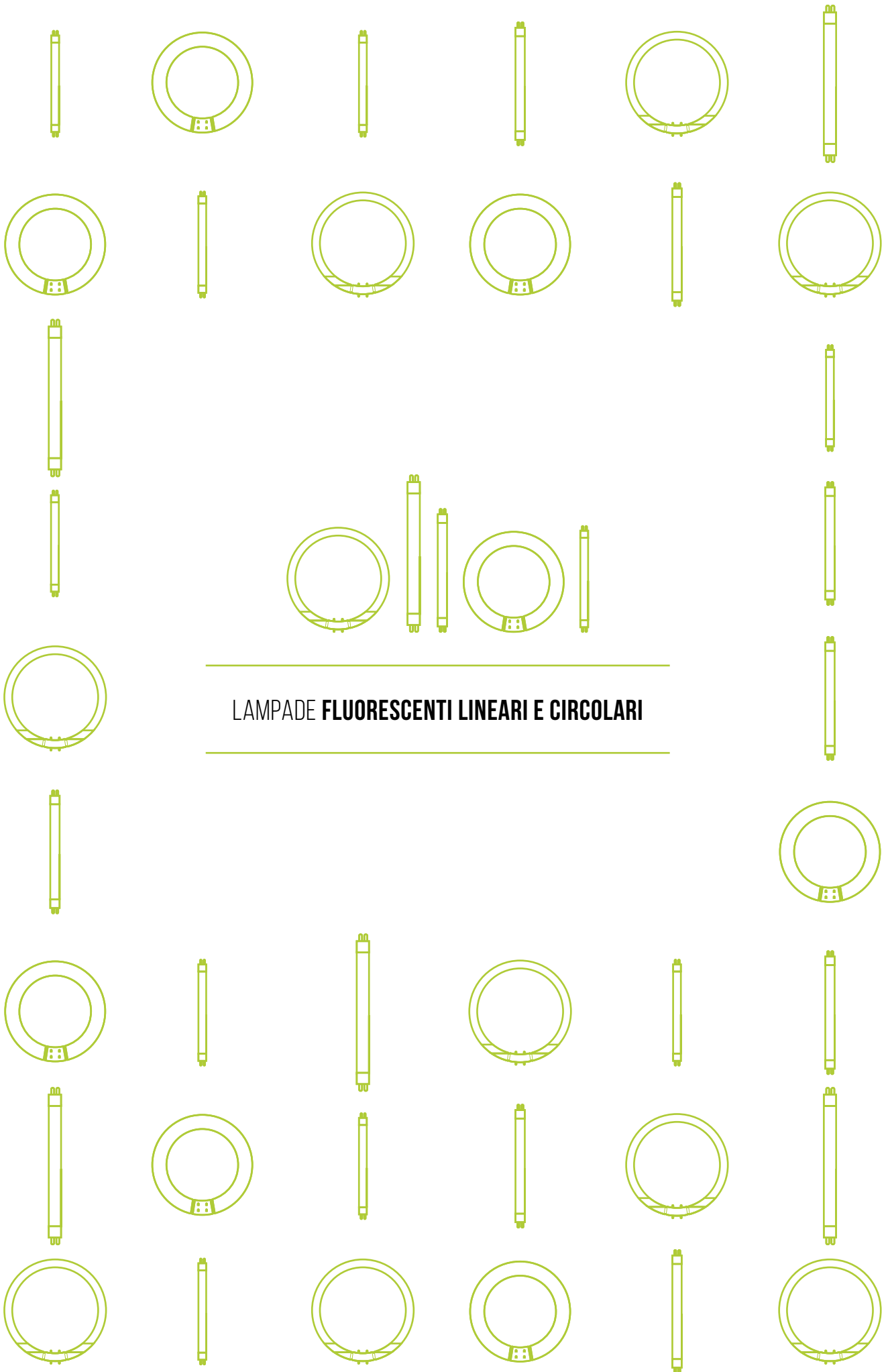

LAMPADE **FLUORESCENTI LINEARI E CIRCOLARI**

**TRIFOSFORO ALTA EFFICIENZA LUMINOSA T5 Ø 16 MM 230V**

AGGIORNATO

CATEGORIA SCONTO 3

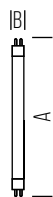

DIMENSIONI	A	B
1	549	16
2	849	16
3	1149	16
4	1449	16

- Lampada fluorescente lineare trifosforo.
- Sistema EQ/HE alta efficienza - durata fino a 24.000 h.
- Funzionamento con alimentatore elettronico.

**24.000 H**  
 YEARS

 ENERGY  
 CLASS **A**

 ENERGY  
 CLASS **A+**

POTENZA COLORE	EQUIVALENZA WATT	BASE	KELVIN	LUMEN LM	LUMEN UTILI	CANDELE CD	FASCIO °	MISURE MM	CODICE	EAN	IMBALLO	PREZZO € IVA ESCLUSA
14 W/865	-	G5	6500	1100	-	-	-	1	<b>L14865</b>	-	30	5,50
14 W/840	-	G5	4000	1200	-	-	-	1	<b>L14840</b>	-	30	5,50
14 W/830	-	G5	3000	1200	-	-	-	1	<b>L14830</b>	-	30	5,50
21 W/865	-	G5	6500	1750	-	-	-	2	<b>L21865</b>	-	30	7,00
21 W/840	-	G5	4000	1900	-	-	-	2	<b>L21840</b>	-	30	7,00
21 W/830	-	G5	3000	1900	-	-	-	2	<b>L21830</b>	-	30	7,00
28 W/865	-	G5	6500	2400	-	-	-	3	<b>L28865</b>	-	30	7,00
28 W/840	-	G5	4000	2600	-	-	-	3	<b>L28840</b>	-	30	7,00
28 W/830	-	G5	3000	2600	-	-	-	3	<b>L28830</b>	-	30	7,00
35 W/865	-	G5	6500	3050	-	-	-	4	<b>L35865</b>	-	30	7,50
35 W/840	-	G5	4000	3300	-	-	-	4	<b>L35840</b>	-	30	7,50
35 W/830	-	G5	3000	3300	-	-	-	4	<b>L35830</b>	-	30	7,50



## TRIFOSFORO ALTA EMISSIONE LUMINOSA T5 Ø 16MM 230V

AGGIORNATO

CATEGORIA SCONTO 3



DIMENSIONI	A	B
1	549	16
2	849	16
3	1149	16
4	1449	16

- Lampada fluorescente lineare Trifosforo.
- Sistema HQ/HO alta emissione luminosa-durata fino a 24.000 h.
- Funzionamento con alimentatore elettronico.

24.000 H YEARS

ENERGY CLASS A

ENERGY CLASS A+

POTENZA COLORE	EQUIVALENZA WATT	BASE	KELVIN	LUMEN LM	LUMEN UTILI	CANDELE CD	FASCIO °	MISURE MM	CODICE	EAN	IMBALLO	PREZZO € IVA ESCLUSA
24 W/865	-	G5	6500	1600	-	-	-	1	L24865	-	30	5,50
24 W/840	-	G5	4000	1750	-	-	-	1	L24840	-	30	5,50
24 W/830	-	G5	3000	1750	-	-	-	1	L24830	-	30	5,50
39 W/840	-	G5	4000	3100	-	-	-	2	L39840	-	30	7,00
39 W/830	-	G5	3000	3100	-	-	-	2	L39830	-	30	7,00
49 W/865	-	G5	6500	3900	-	-	-	4	L49865	-	30	7,50
49 W/840	-	G5	4000	4300	-	-	-	4	L49840	-	30	7,50
49 W/830	-	G5	3000	4300	-	-	-	4	L49830	-	30	7,50
54 W/865	-	G5	6500	4100	-	-	-	3	L54865	-	30	7,00
54 W/840	-	G5	4000	4450	-	-	-	3	L54840	-	30	7,00
54 W/830	-	G5	3000	4450	-	-	-	3	L54830	-	30	7,00
80 W/840	-	G5	4000	6150	-	-	-	4	L80840	-	30	7,50
80 W/830	-	G5	3000	6150	-	-	-	4	L80830	-	30	7,50



## TRIFOSFORO SHORT T5 Ø 16MM 220V

AGGIORNATO

CATEGORIA SCONTO 3



DIMENSIONI	A	B
1	212	16
2	288	16
3	517	16

- Lampada fluorescente lineare Short T5.
- Sistema HQ/HO alta emissione luminosa-durata fino a 12.000 h.
- Funzionamento con alimentatore elettronico.

12.000 H YEARS

ENERGY CLASS A

POTENZA WATT	EQUIVALENZA WATT	BASE	KELVIN	LUMEN LM	LUMEN UTILI	CANDELE CD	FASCIO °	MISURE MM	CODICE	EAN	IMBALLO	PREZZO € IVA ESCLUSA
6	-	G5	6000	240	-	-	-	1	L61TA	6435200171214	25	3,00
6	-	G5	4000	320	-	-	-	1	L62TA	6435200171238	25	3,00
8	-	G5	6000	400	-	-	-	2	L81TA	6435200171252	25	3,10
8	-	G5	4000	440	-	-	-	2	L82TA	6435200171276	25	3,10
13	-	G5	6000	950	-	-	-	3	L131TA	6435200171290	25	3,20
13	-	G5	4000	980	-	-	-	3	L132TA	6435200171313	25	3,20

**TRIFOSFORO T8 Ø 26MM 230V**

AGGIORNATO

CATEGORIA SCONTO 3

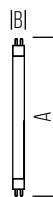

DIMENSIONI	A	B
1	438	26
2	590	26
3	895	26
4	1200	26
5	1500	26

- Lampada fluorescente lineare trifosforo.
- Tubi speciali da 38W disponibili su richiesta.
- Funzionamento con alimentatore elettronico o reattore magnetico.

 20.000 H  
 YEARS

ENERGY CLASS A

POTENZA COLORE	EQUIVALENZA WATT	BASE	KELVIN	LUMEN LM	LUMEN UTILI	CANDELE CD	FASCIO °	MISURE MM	CODICE	EAN	IMBALLO	PREZZO € IVA ESCLUSA
15	-	G13	6500	945	-	-	-	1	L151TA	6435200171139	25	3,30
15	-	G13	4000	900	-	-	-	1	L152TA	6435200171153	25	3,30
18	-	G13	6500	1300	-	-	-	2	L181T	6435200014177	25	3,60
18	-	G13	4000	1350	-	-	-	2	L182T	6435200000385	25	3,60
30	-	G13	6500	2230	-	-	-	3	L301TA	6435200171177	25	3,40
30	-	G13	4000	2400	-	-	-	3	L302TA	6435200171191	25	3,40
36	-	G13	6500	3250	-	-	-	4	L361T	6435200007520	25	3,60
36	-	G13	4000	3350	-	-	-	4	L362T	6435200003348	25	3,60
58	-	G13	6500	5000	-	-	-	5	L581T	6435200007537	25	4,50
58	-	G13	4000	5200	-	-	-	5	L582T	6435200003355	25	4,50

**CIRCOLARI TRIFOSFORO T9 230V**

CATEGORIA SCONTO 9

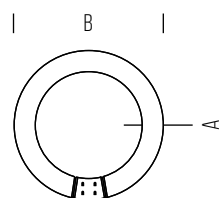

DIMENSIONI	A	B
1	30	210
2	30	305
3	30	406

 20.000 H  
 YEARS

ENERGY CLASS A

ENERGY CLASS B

POTENZA COLORE	EQUIVALENZA WATT	BASE	KELVIN	LUMEN LM	LUMEN UTILI	CANDELE CD	FASCIO °	MISURE MM	CODICE	EAN	IMBALLO	PREZZO € IVA ESCLUSA
22 W/865	-	G10Q	6500	1200	-	-	-	1	LR221T	6435200014580	12	7,50
22 W/842	-	G10Q	4200	1350	-	-	-	1	LR222T	6435200014597	12	7,50
32 W/865	-	G10Q	6500	2000	-	-	-	2	LR321T	6435200014610	12	8,90
32 W/842	-	G10Q	4200	2300	-	-	-	2	LR322T	6435200014627	12	8,90
40 W/865	-	G10Q	6500	2800	-	-	-	3	LR401T	6435200014641	12	12,70
40 W/842	-	G10Q	4200	3200	-	-	-	3	LR402T	6435200014658	12	12,70

## CIRCOLARI T5 230V

CATEGORIA SCONTO 9

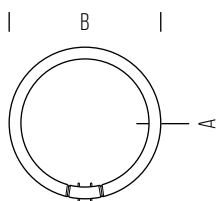

DIMENSIONI	A	B
1	16	230
2	16	300
3	16	305

20,000 H  
YEARS

ENERGY  
CLASS B

POTENZA COLORE	EQUIVALENZA WATT	BASE	KELVIN	LUMEN LM	LUMEN UTILI	CANDELE CD	FASCIO °	MISURE MM	CODICE	EAN	IMBALLO	PREZZO € IVA ESCLUSA
22 W/865	-	2GX13	6500	1700	-	-	-	1	LR5221	6435200118714	12	19,00
22 W/842	-	2GX13	4200	1800	-	-	-	1	LR5222	6435200118721	12	19,00
40 W/865	-	2GX13	6500	3000	-	-	-	2	LR5401	6435200118738	12	25,00
40 W/842	-	2GX13	4200	3200	-	-	-	2	LR5402	6435200118745	12	25,00
55 W/865	-	2GX13	6500	3800	-	-	-	3	LR5551	6435200118752	12	25,00
55 W/842	-	2GX13	4200	4200	-	-	-	3	LR5552	6435200118769	12	25,00

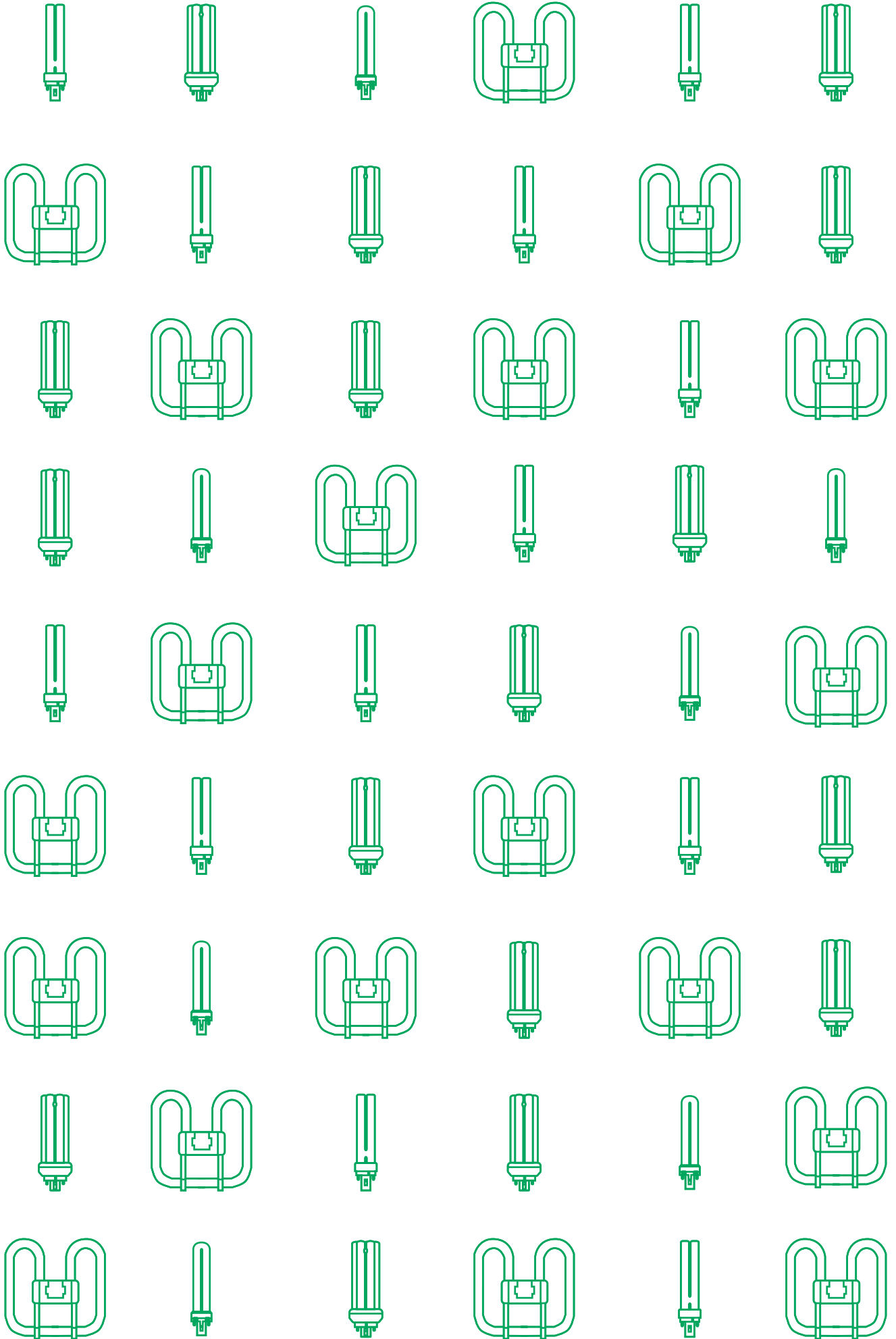

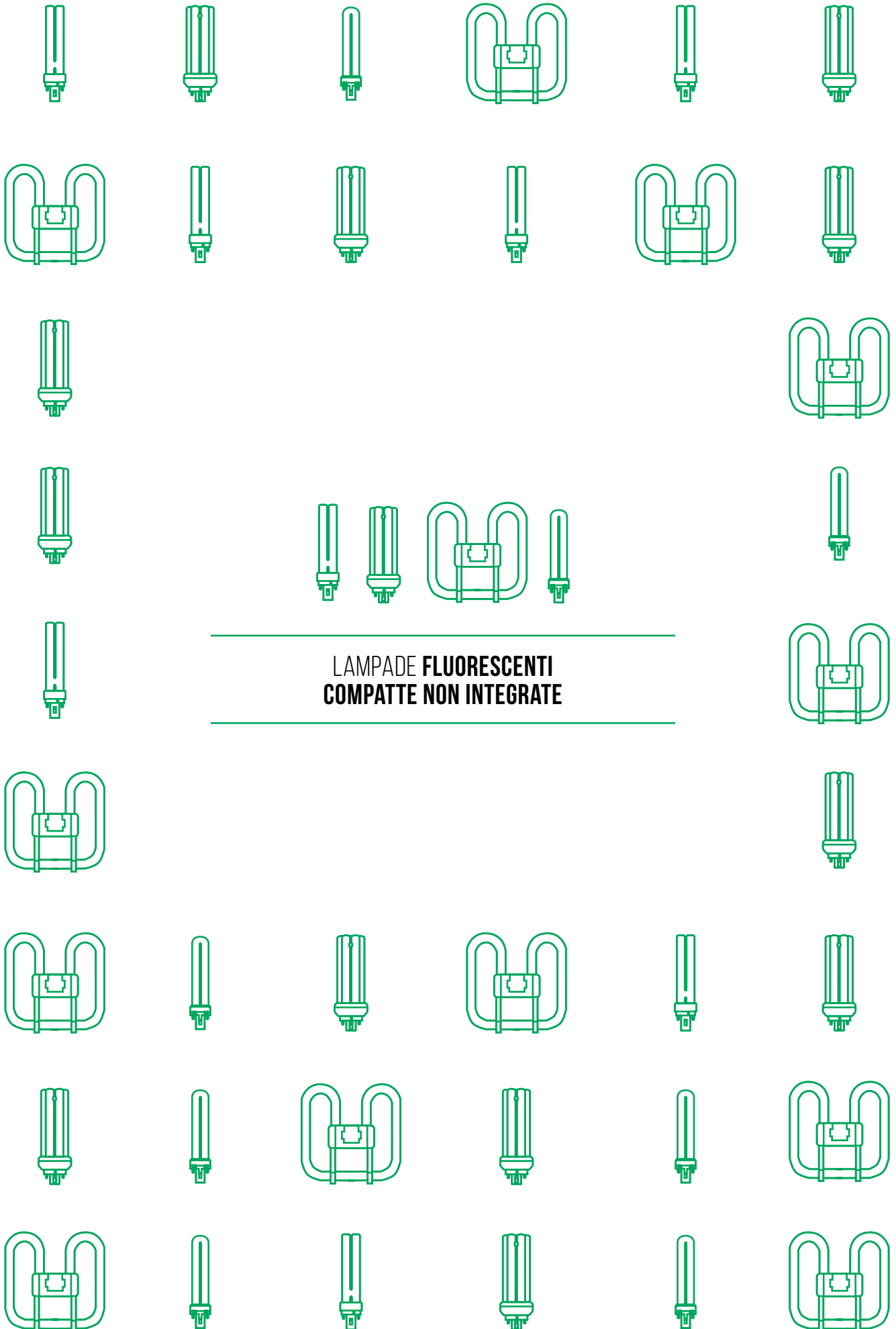

LAMPADE **FLUORESCENTI**  
**COMPATTE NON INTEGRATE**

**AL LONGLIFE 230V**

CATEGORIA SCONTO 10

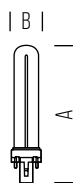

DIMENSIONI	A	B
1	136,5	27
2	167	27
3	237	27

- Lampada fluorescente compatta non integrata.
- 2 pin con starter incorporato.
- Alimentatore convenzionale RA = 1B.



POTENZA COLORE	EQUIVALENZA WATT	BASE	KELVIN	LUMEN LM	LUMEN UTILI	CANDELE CD	FASCIO °	MISURE MM	CODICE	EAN	IMBALLO	PREZZO € IVA ESCLUSA
7	-	G23	4000	400	-	-	-	1	AL72	-	10	4,00
7	-	G23	2700	425	-	-	-	1	AL727	-	10	4,00
9	-	G23	4000	600	-	-	-	2	AL92	-	10	4,00
9	-	G23	2700	600	-	-	-	2	AL927	-	10	4,00
11	-	G23	4000	900	-	-	-	3	AL112	-	10	4,00
11	-	G23	2700	900	-	-	-	3	AL1127	-	10	4,00

**ALC LONGLIFE 230V**

CATEGORIA SCONTO 10

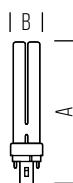

DIMENSIONI	A	B
1	108	21,5
2	139	21,5
3	154	27
4	169,5	27

- Lampada fluorescente compatta non integrata.
- 2 pin con starter incorporato.
- Alimentatore convenzionale RA = 1B.



POTENZA COLORE	EQUIVALENZA WATT	BASE	KELVIN	LUMEN LM	LUMEN UTILI	CANDELE CD	FASCIO °	MISURE MM	CODICE	EAN	IMBALLO	PREZZO € IVA ESCLUSA
10	-	G24D-1	4000	600	-	-	-	1	ALC102	-	10	5,20
13	-	G24D-1	4000	900	-	-	-	2	ALC132	-	10	5,20
18	-	G24D-2	4000	1200	-	-	-	3	ALC182	-	10	5,20
18	-	G24D-2	2700	1200	-	-	-	3	ALC1827	-	10	5,20
18	-	G24D-2	3000	1200	-	-	-	3	ALC183	-	10	5,20
26	-	G24D-3	4000	1800	-	-	-	4	ALC262	-	10	5,20
26	-	G24D-3	3000	1800	-	-	-	4	ALC263	-	10	5,20





## ALL LONGLIFE 230V

CATEGORIA SCONTO 10

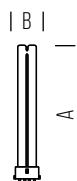

DIMENSIONI	A	B
1	225	40
2	320	40
3	415	40
4	532	40

- Lampada fluorescente compatta non integrata.
- 4 pin - RA = 1B.
- Alimentatore convenzionale o elettronico.



POTENZA COLORE	EQUIVALENZA WATT	BASE	KELVIN	LUMEN LM	LUMEN UTILI	CANDELE CD	FASCIO °	MISURE MM	CODICE	EAN	IMBALLO	PREZZO € IVA ESCLUSA
18	-	2G11	4000	1250	-	-	-	1	ALL182	-	10	6,40
18	-	2G11	3000	1250	-	-	-	1	ALL183	-	10	6,40
24	-	2G11	4000	1800	-	-	-	2	ALL242	-	10	7,40
24	-	2G11	3000	1800	-	-	-	2	ALL243	-	10	7,40
36	-	2G11	4000	2900	-	-	-	3	ALL362	-	10	7,40
36	-	2G11	3000	2900	-	-	-	3	ALL363	-	10	7,40
55	-	2G11	4000	4600	-	-	-	4	ALL552	-	10	8,70
55	-	2G11	3000	4800	-	-	-	4	ALL553	-	10	8,70



## ALDE LONGLIFE 230V

CATEGORIA SCONTO 10

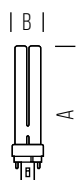

DIMENSIONI	A	B
1	125.5	35
2	146.5	35
3	162	35

- Lampada fluorescente compatta non integrata.
- 4 pin.
- Alimentatore elettronico.



POTENZA COLORE	EQUIVALENZA WATT	BASE	KELVIN	LUMEN LM	LUMEN UTILI	CANDELE CD	FASCIO °	MISURE MM	CODICE	EAN	IMBALLO	PREZZO € IVA ESCLUSA
13	-	G24Q-1	4000	900	-	-	-	1	ALDE13840	-	10	5,10
18	-	G24Q-2	4000	1200	-	-	-	2	ALDE18840	-	10	5,10
18	-	G24Q-2	2700	1200	-	-	-	2	ALDE18827	-	10	5,10
26	-	G24Q-3	4000	1800	-	-	-	3	ALDE26840	-	10	5,10

**ALSE LONGLIFE 230V**

CATEGORIA SCONTO 10

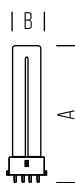

DIMENSIONI	A	B
1	151	27
2	222	27

- Lampada fluorescente compatta non integrata.
- 4 pin.
- Alimentatore elettronico.

**15.000 H**  
**YEARS**

POTENZA COLORE	EQUIVALENZA WATT	BASE	KELVIN	LUMEN LM	LUMEN UTILI	CANDELE CD	FASCIO °	MISURE MM	CODICE	EAN	IMBALLO	PREZZO € IVA ESCLUSA
9	-	267	4000	600	-	-	-	1	<b>ALSE9840</b>	-	10	4,00
9	-	267	2700	600	-	-	-	1	<b>ALSE9827</b>	-	10	4,00
11	-	267	4000	900	-	-	-	2	<b>ALSE11840</b>	-	10	4,00
11	-	267	2700	900	-	-	-	2	<b>ALSE11827</b>	-	10	4,00

**ALTE LONGLIFE 230V**

CATEGORIA SCONTO 10

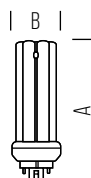

DIMENSIONI	A	B
1	120.7	49
2	133.2	49
3	141.2	49
4	163.2	49

- Lampada fluorescente compatta non integrata.
- 4 pin.
- Alimentatore elettronico.

**20.000 H**  
**YEARS**

POTENZA COLORE	EQUIVALENZA WATT	BASE	KELVIN	LUMEN LM	LUMEN UTILI	CANDELE CD	FASCIO °	MISURE MM	CODICE	EAN	IMBALLO	PREZZO € IVA ESCLUSA
18	-	GX24Q-2	3000	1200	-	-	-	1	<b>ALTE18830</b>	-	10	8,15
26	-	GX24Q-3	4000	1800	-	-	-	2	<b>ALTE26840</b>	-	10	8,35
26	-	GX24Q-3	3000	1800	-	-	-	2	<b>ALTE26830</b>	-	10	8,35
32	-	GX24Q-3	3000	2400	-	-	-	3	<b>ALTE32830</b>	-	10	8,35
42	-	GX24Q-4	4000	3200	-	-	-	4	<b>ALTE42840</b>	-	10	9,25
42	-	GX24Q-4	3000	3200	-	-	-	4	<b>ALTE42830</b>	-	10	9,25

## 2C LONGLIFE 230V

CATEGORIA SCONTO 10

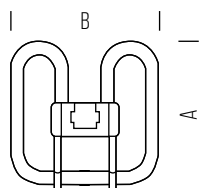
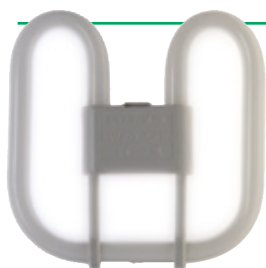

DIMENSIONI	A	B
1	133	136
2	197	200

- Lampada fluorescente compatta non integrata.
- 2/4 pin.
- Alimentatore elettronico e ferromagnetico.



POTENZA WATT	EQUIVALENZA WATT	BASE	KELVIN	LUMEN LM	LUMEN UTILI	CANDELE CD	FASCIO °	MISURE MM	CODICE	EAN	IMBALLO	PREZZO € IVA ESCLUSA
16	-	GR8-2PIN	6500	1050	-	-	-	1	<b>16CLUB</b>	6435200206244	10	5,45
16	-	GR10-4PIN	6500	1050	-	-	-	1	<b>1614P</b>	6435200206145	10	5,45
16	-	GR8-2PIN	2700	1050	-	-	-	1	<b>16272P</b>	6435200206206	10	5,45
<b>NEW</b> 16	-	GR8-2PIN	3000	1050	-	-	-	2	<b>4913916</b>	6435200009074	10	5,45
16	-	GR10-4PIN	2700	1050	-	-	-	1	<b>16274P</b>	6435200206169	10	5,45
<b>NEW</b> 16	-	GR10-4PIN	3000	1050	-	-	-	2	<b>4914016</b>	6435200009081	10	5,45
16	-	GR8-2PIN	3500	1050	-	-	-	1	<b>16352P</b>	6435200206220	10	5,45
16	-	GR10-4PIN	3500	1050	-	-	-	1	<b>16354P</b>	6435200206183	10	5,45
28	-	GR10-4PIN	6500	2250	-	-	-	2	<b>2814P</b>	6435200206268	10	7,50
28	-	GR10-4PIN	2700	2250	-	-	-	2	<b>28274P</b>	6435200206282	10	7,50
<b>NEW</b> 28	-	GR10-4PIN	3000	2250	-	-	-	2	<b>4914028</b>	6435200009098	10	7,50
28	-	GR10-4PIN	3500	2050	-	-	-	2	<b>28354P</b>	6435200206305	10	7,50

- Le lampade 2C da 16 Watt con base GR8 2 pin sono adatte al ricambio delle lampade esaurite sugli apparecchi d'illuminazione senza starter.
- Le lampade 2C da 16 Watt e 28 Watt con base GR10 4 pin sono adatte al ricambio delle lampade esaurite sugli apparecchi d'illuminazione con starter.



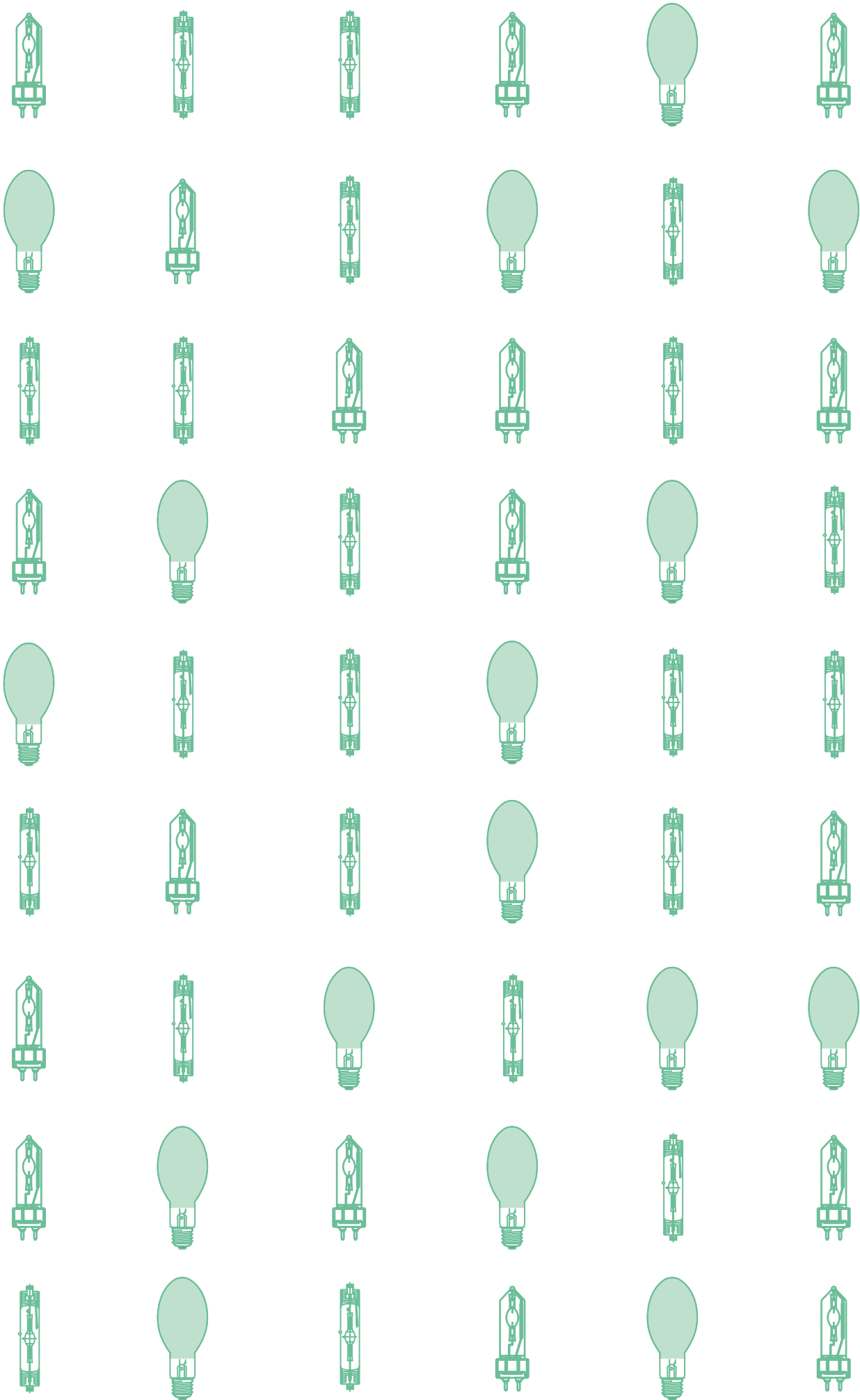



LAMPAD E A **SCARICA**

**NCK-G CERAMIC 230V**

CATEGORIA SCONTO 7

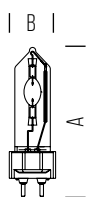

DIMENSIONI	A	B
1	90	15
2	90	20

- Lampada a ioduri metallici con tecnologia ceramica.
- Resa cromatica >90 per le 942 e >80 per le 830.
- Durata di vita migliorata rispetto ad una tradizionale lampada ad ioduri.

**15,000 H**  
 YEARS

POTENZA WATT	BASE	AMPERE	KELVIN	LUMEN LM	LUMEN UTILI	CLASSE ENERGETICA	MISURE MM	CODICE	EAN	IMBALLO	PREZZO € IVA ESCLUSA
35 W/942	G12	-	4200	3500	-	A+	1	NCKG35NW	-	25	35,00
35 W/830	G12	-	3000	3500	-	A+	1	NCKG35WW	-	25	35,00
70 W/942	G12	-	4200	6700	-	A	2	NCKG70NW	-	25	35,00
70 W/830	G12	-	3000	6700	-	A	2	NCKG70WW	-	25	35,00
150 W/942	G12	-	4200	14000	-	A	2	NCKG150NW	-	25	35,00
150 W/830	G12	-	3000	14000	-	A	2	NCKG150WW	-	25	35,00

**NCK-TC CERAMIC 230V**

CATEGORIA SCONTO 7

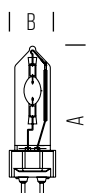

DIMENSIONI	A	B
1	85	14,5



**15,000 H**  
 YEARS

POTENZA WATT	BASE	AMPERE	KELVIN	LUMEN LM	LUMEN UTILI	CLASSE ENERGETICA	MISURE MM	CODICE	EAN	IMBALLO	PREZZO € IVA ESCLUSA
35 W/942	G8.5	-	4200	3500	-	A+	1	NCKTC35NW	-	25	35,00
35 W/830	G8.5	-	3000	3500	-	A+	1	NCKTC35WW	-	25	35,00
70 W/942	G8.5	-	4200	6700	-	A	1	NCKTC70NW	-	25	35,00
70 W/830	G8.5	-	3000	6700	-	A	1	NCKTC70WW	-	25	35,00

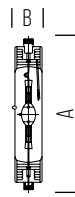

## NACHROMA DOPPIO ATTACCO 230V

CATEGORIA SCONTO 7



DIMENSIONI	A	B
1	19	115
2	22	132

- Lampada a ioduri metallici biattacco al quarzo.
- Adatta per reattore ai vapori di sodio ad alta pressione (RENA).
- Necessita di accenditore per lampade a ioduri metallici.



POTENZA WATT	BASE	AMPERE	KELVIN	LUMEN LM	LUMEN UTILI	FASCIO °	MISURE MM	CODICE	EAN	IMBALLO	PREZZO € IVA ESCLUSA
70	RX7S	1,00	5200	5000	-	-	1	NCDE70DW	-	10	22,60
70	RX7S	1,00	4200	8000	-	-	1	NCDE70NW	-	10	22,60
70	RX7S	1,00	3200	6500	-	-	1	NCDE70WW	-	10	22,60
150	RX7S-24	1,85	5200	9500	-	-	2	NCDE150DW	-	10	22,60
150	RX7S-24	1,85	4200	13000	-	-	2	NCDE150NW	-	10	22,60
150	RX7S-24	1,85	3200	15000	-	-	2	NCDE150WW	-	10	22,60



## NACHROMA ELLISSOIALE DIFFONDENTE 230V

CATEGORIA SCONTO 7

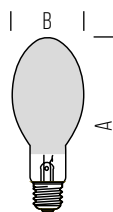

DIMENSIONI	A	B
1	156	75
2	156	70
3	186	75
4	227	90
5	279	120

- Lampada al sodio ad alta pressione ellissoidale con bulbo diffondente.
- Adatta per reattore ai vapori di sodio ad alta pressione (RENA).
- Necessita di accenditore.



POTENZA WATT	BASE	AMPERE	KELVIN	LUMEN LM	LUMEN UTILI	FASCIO °	MISURE MM	CODICE	EAN	IMBALLO	PREZZO € IVA ESCLUSA
70*	E27	-	2500	5600	-	-	1	NAE70SI	-	12	29,00
70	E27	-	2500	6100	-	-	2	NAES70	-	12	26,30
100	E40	-	2500	9500	-	-	3	NAES100	-	12	24,00
150	E40	-	2500	16700	-	-	4	NAES150	-	12	27,20
250	E40	-	2500	31000	-	-	4	NAES250	-	12	29,40
400	E40	-	2500	52250	-	-	5	NAES400	-	12	34,30

\* Lampada disponibile su ordinazione



## NATRALOX SUPER TUBOLARE TRASPARENTE 230V

CATEGORIA SCONTO 7

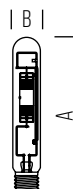

DIMENSIONI	A	B
1	156	38
2	211	46
3	257	46
4	271	46

- Lampada al sodio ad alta pressione tubolare con bulbo trasparente.
- Adatta per reattore ai vapori di sodio ad alta pressione (RENA).
- Necessita di accenditore.



POTENZA WATT	BASE	AMPERE	KELVIN	LUMEN LM	LUMEN UTILI	FASCIO °	MISURE MM	CODICE	EAN	IMBALLO	PREZZO € IVA ESCLUSA
70	E27	-	2500	6500	-	-	1	NATS70	-	12	24,70
100	E40	-	2500	10000	-	-	2	NATS100	-	12	26,00
150	E40	-	2500	17500	-	-	2	NATS150	-	12	25,90
250	E40	-	2500	33000	-	-	3	NATS250	-	12	28,20
400	E40	-	2500	54500	-	-	4	NATS400	-	12	32,90



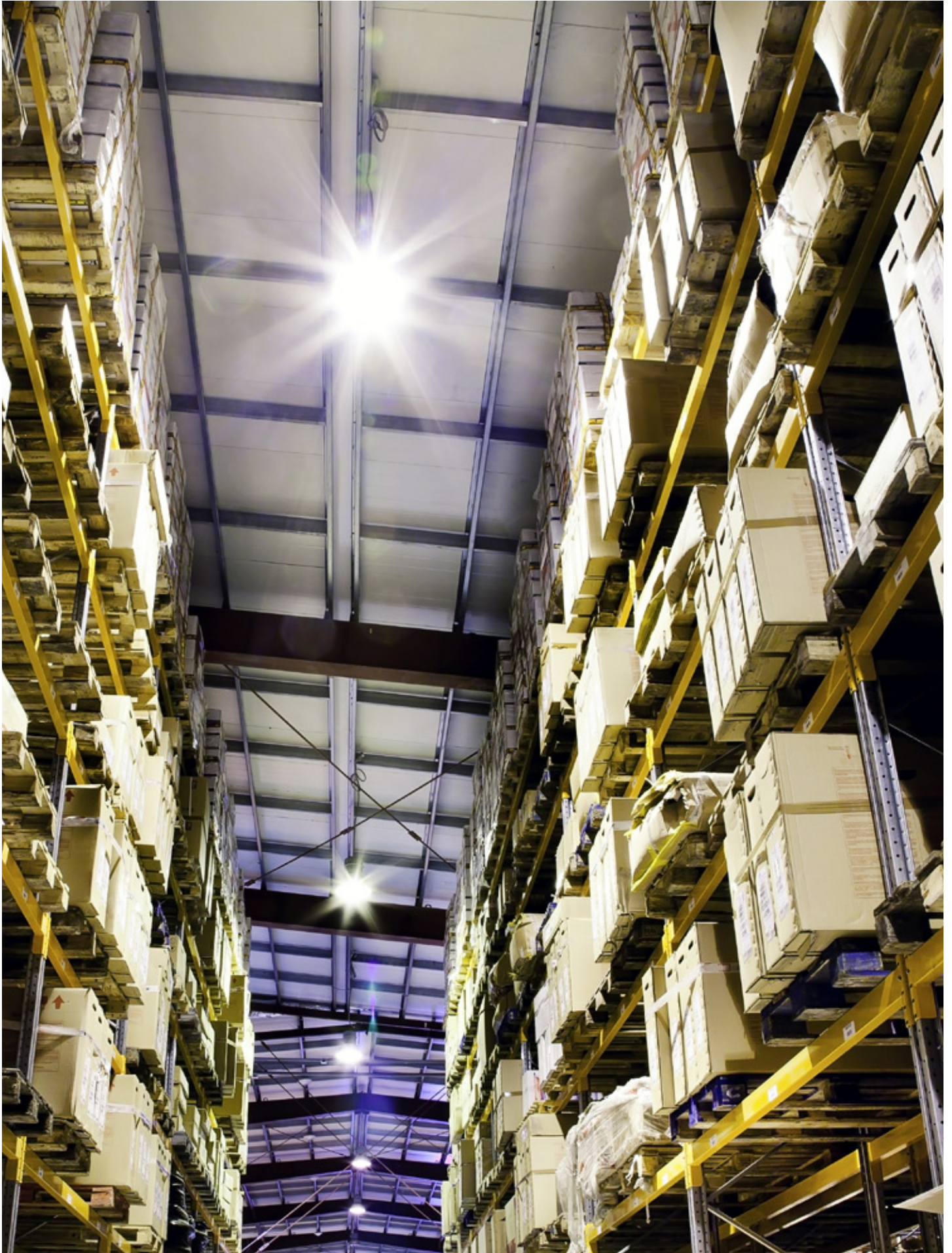

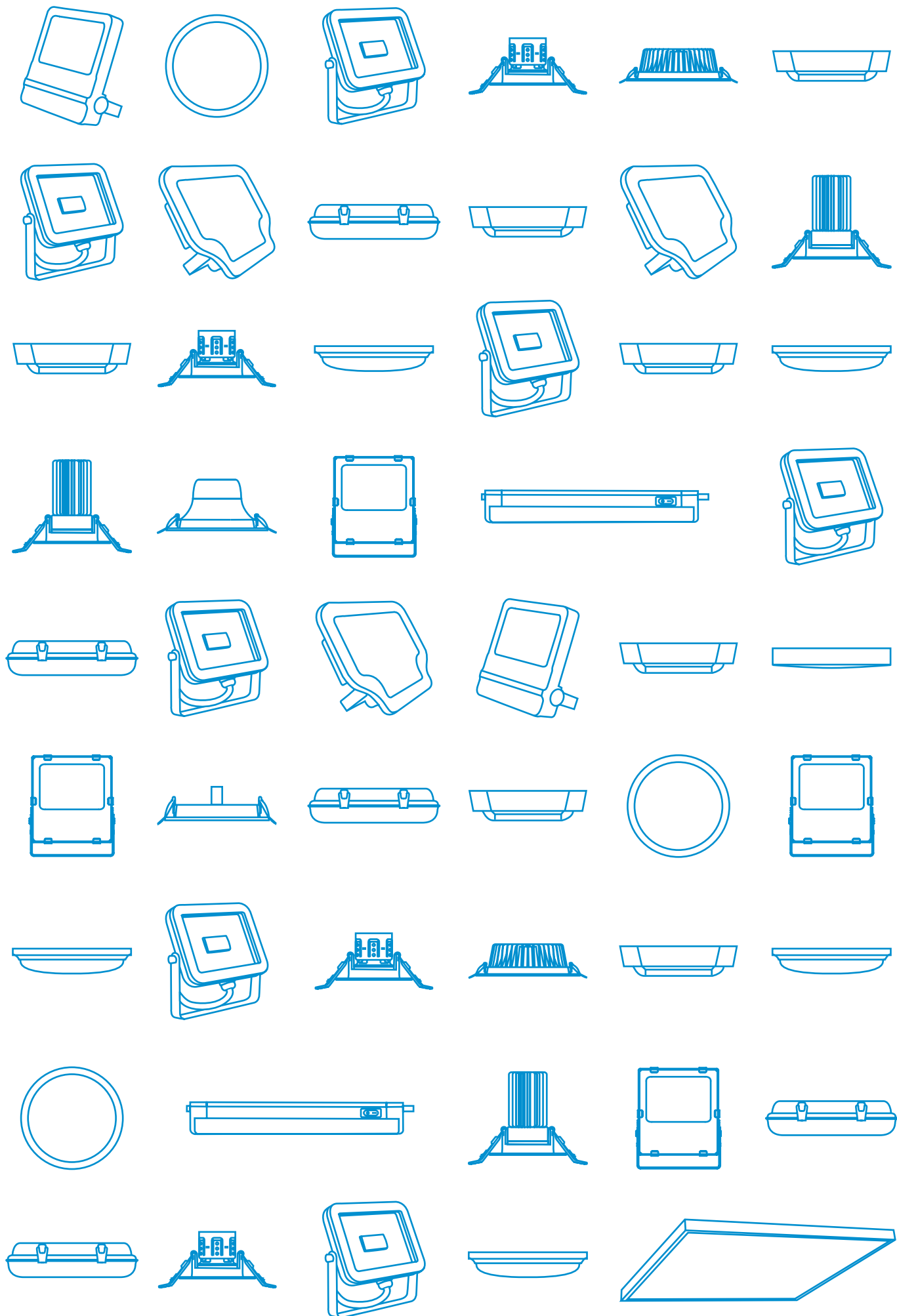

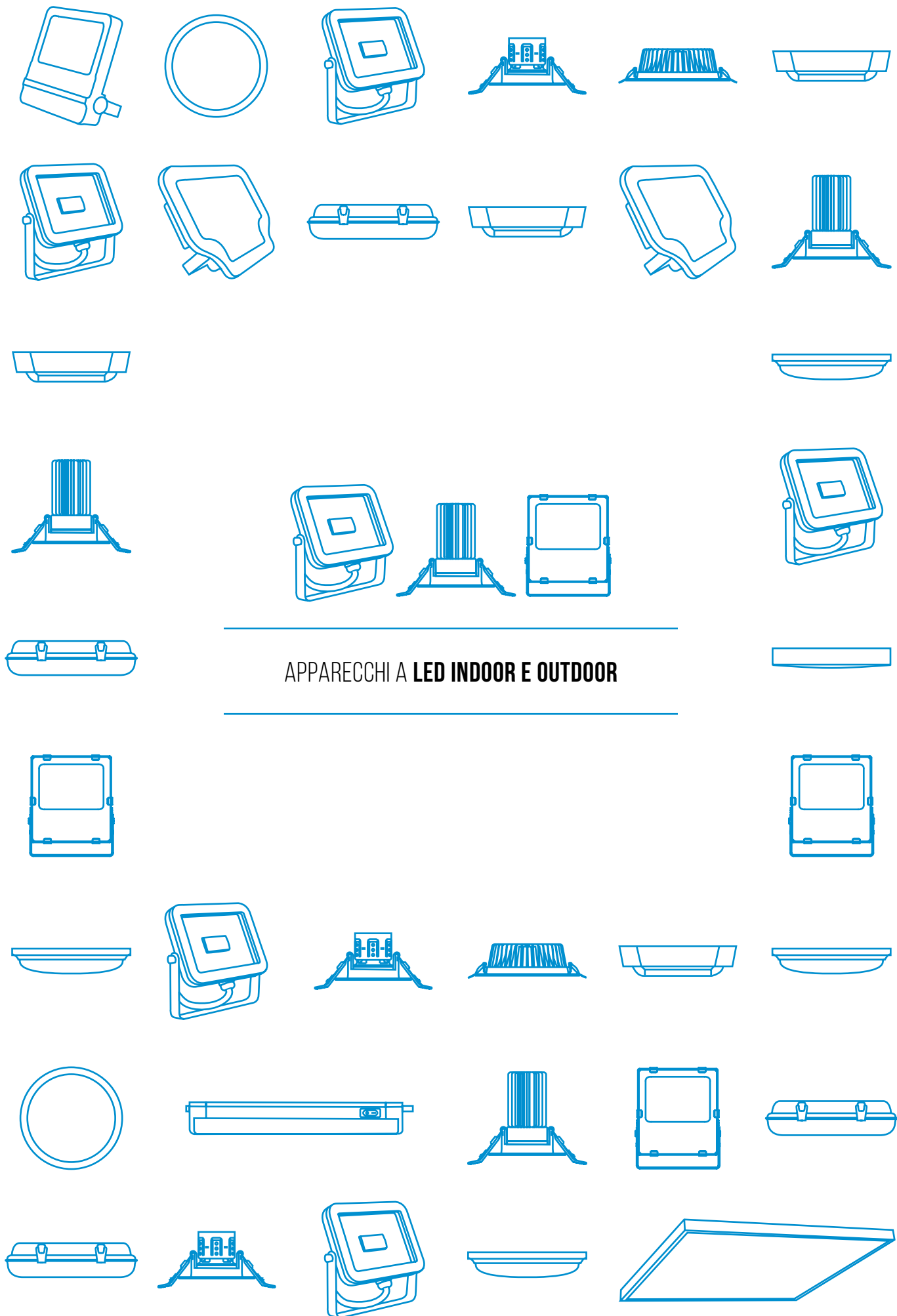



---

APPARECCHI A **LED INDOOR E OUTDOOR**

---

**PANNELLO A LED ALTA EFFICIENZA 220-240V**
**AGGIORNATO**

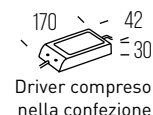
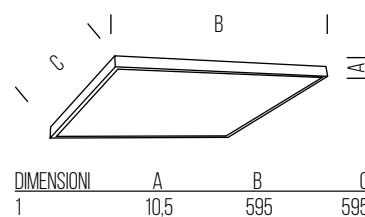
CATEGORIA SCONTO 23



- Linea di apparecchi led ultrasottili 600 x 600 mm - spessore 10.5 mm
- Distribuzione della luce uniforme
- Alta efficienza luminosa (100 lm/W) mod. 30W
- Driver elettronico incluso con connettore a sgancio rapido
- Opzionale driver dimmerabile 0-10V e kit emergenza 6h autonomia
- Kit opzionali per montaggio a plafone e a sospensione



	POTENZA WATT	EQUIVALENZA WATT	KELVIN	LUMEN LM	LUMEN UTILI	FASCIO °	MISURE MM	CODICE	EAN	IMBALLO	PREZZO € IVA ESCLUSA
<b>NEW</b>	30,0	-	3000	3000	-	120	1	<b>LD2PAN3052</b>	8031453017323	2	60,90
<b>NEW</b>	30,0	-	4000	3000	-	120	1	<b>LD2PAN3053</b>	8031453017347	2	60,90
	60,0	-	3000	4700	-	120	1	<b>LD2PAN6052-2</b>	8031453015091	2	88,90
	60,0	-	4000	5200	-	120	1	<b>LD2PAN6053-2</b>	8031453015114	2	88,90

## PANNELLO A LED ALTA EFFICIENZA 220-240V

NEW

CATEGORIA SCONTO 23

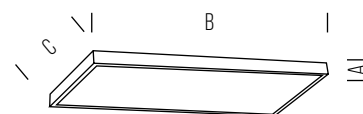
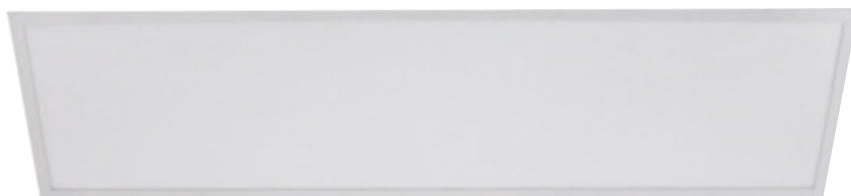

DIMENSIONI	A	B	C
1	10,5	1195	295



Driver compreso nella confezione

- Linea di apparecchi led ultrasottili 1200 x 300 mm - spessore 10.5 mm
- Distribuzione della luce uniforme
- Alta efficienza luminosa (100 lm/W)
- Driver elettronico incluso con connettore a sgancio rapido
- Opzionale driver dimmerabile 0-10V e kit emergenza 6h autonomia
- Kit opzionali per montaggio a plafone e a sospensione



POTENZA WATT	EQUIVALENZA WATT	KELVIN	LUMEN LM	LUMEN UTILI	FASCIO °	MISURE MM	CODICE	EAN	IMBALLO	PREZZO € IVA ESCLUSA
30,0	-	3000	3000	-	120	1	<b>LD2PAN3052B</b>	8031453019044	2	76,90
30,0	-	4000	3000	-	120	1	<b>LD2PAN3053B</b>	8031453019037	2	76,90

## PANNELLO A LED ALTA EFFICIENZA UGR<19 220-240V

NEW

CATEGORIA SCONTO 23

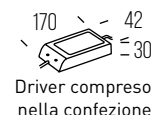
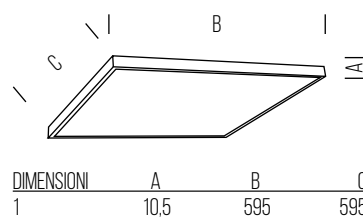

- Linea di apparecchi led ultrasottili 600 x 600 mm - spessore 10.5 mm
- Distribuzione della luce uniforme
- Alta efficienza luminosa (100 lm/W)
- Driver elettronico incluso con connettore a sgancio rapido
- Versione a basso abbagliamento UGR <19
- Opzionale driver dimmerabile 0-10V e kit emergenza 6h autonomia
- Kit opzionali per montaggio a plafone e a sospensione



POTENZA WATT	EQUIVALENZA WATT	KELVIN	LUMEN LM	LUMEN UTILI	FASCIO °	MISURE MM	CODICE	EAN	IMBALLO	PREZZO € IVA ESCLUSA
33,0	-	4000	3300	-	90	1	LD2PAN3053U	8031453018214	2	95,90

## LED DRIVER PER PANNELLO A LED 220-240V

AGGIORNATO

CATEGORIA SCONTO 23

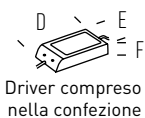

DIMENSIONI DRIVER	D	E	F
1	170	42	30
2	180	52	32



POTENZA WATT	EQUIVALENZA WATT	BASE	KELVIN	LUMEN LM	LUMEN UTILI	FASCIO °	MISURE MM	CODICE	EAN	IMBALLO	PREZZO € IVA ESCLUSA
30,0	-	-	-	-	-	-	1	LD2PAND30	8031453017361	50	24,00
30,0	-	-	-	-	-	-	2	LD2PAND30D	8031453019051	50	36,70
60,0	-	-	-	-	-	-	2	LD2PAND60-2	8031453015138	50	38,60



### KIT MONTAGGIO SOSPENSIONE (OPZIONALE)

CODICE	EAN	IMBALLO	PREZZO € IVA ESCLUSA
LD2PANCAB	8031453006839	50	9,99



### KIT MONTAGGIO A SOFFITTO (OPZIONALE)

CODICE	MISURE	EAN	IMBALLO	PREZZO € IVA ESCLUSA
LD2PANFRM	600X600X35	8031453006815	10	26,30
LD2PANKITB	-	8031453008253	6	16,00

CATEGORIA SCONTO 23

## KIT MONTAGGIO A SOFFITTO UNIVERSALE (OPZIONALE)

AGGIORNATO

CATEGORIA SCONTO 23



CODICE	MISURE	EAN	IMBALLO	PREZZO € IVA ESCLUSA
LD2PANFRM-2	600X600X35	8031453017682	10	26,30
LD2PANFRM-2B	1200X300X35	8031453017705	10	26,30

## KIT EMERGENZA 3H AUT.-30V-200mA- BATT.3000mAH 220-240V

CATEGORIA SCONTO 23



POTENZA WATT	EQUIVALENZA WATT	BASE	KELVIN	CODICE	EAN	IMBALLO	PREZZO € IVA ESCLUSA
6	-	-	-	LD2PANEMK	8031453012618	20	119,00

### LD2PAN3052

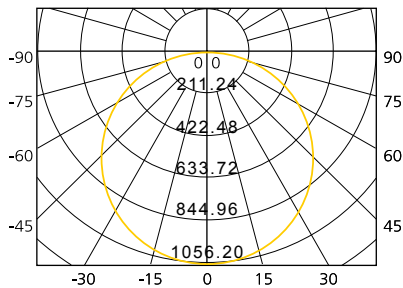
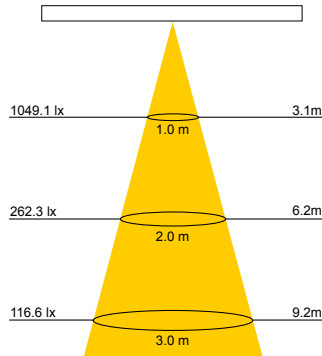

### LD2PAN3053

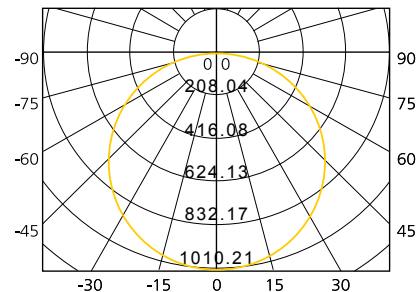
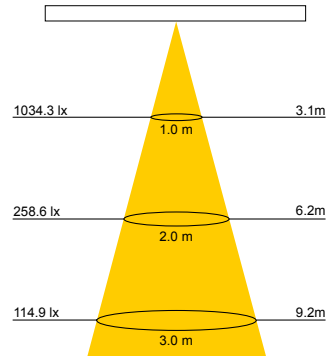

### LD2PAN6052-2

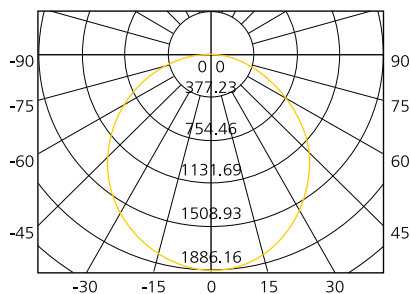
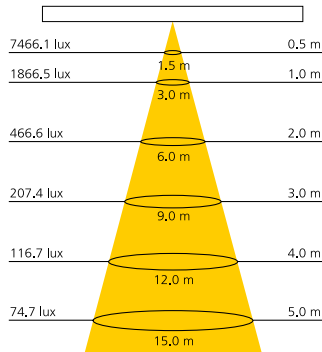

### LD2PAN6053-3

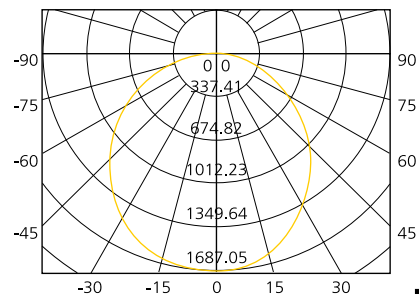
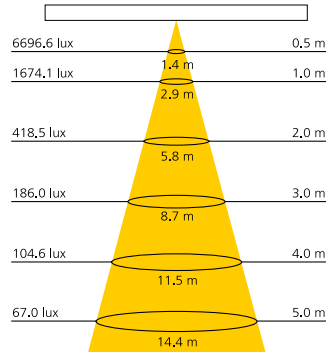

**LD2PAN3052B**

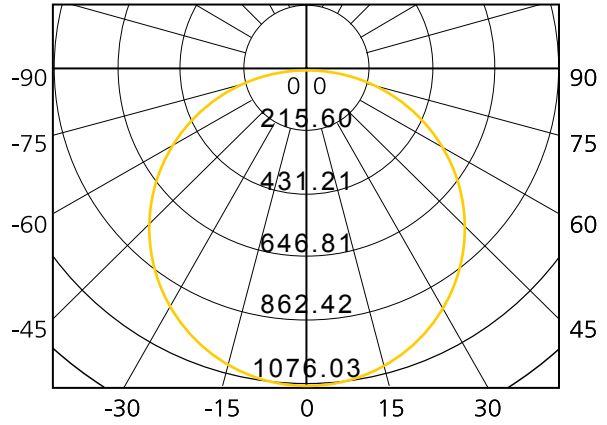
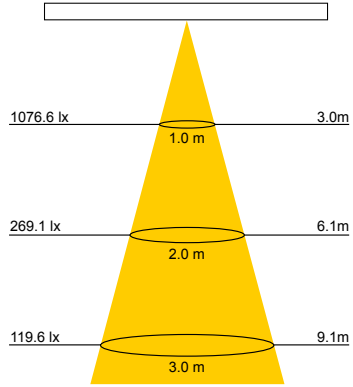

**LD2PAN3053B**

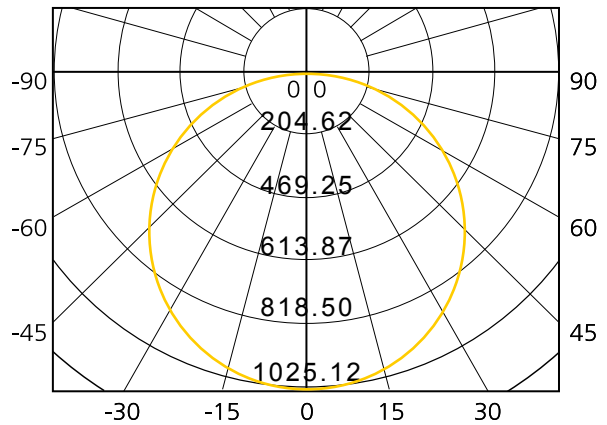
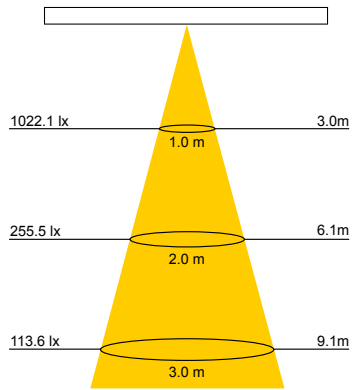

**LD2PAN3053U**

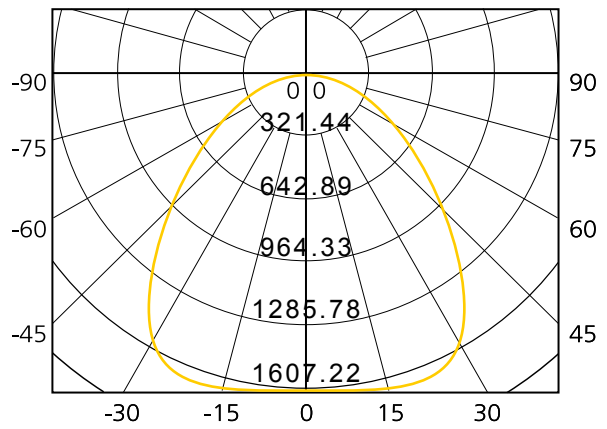
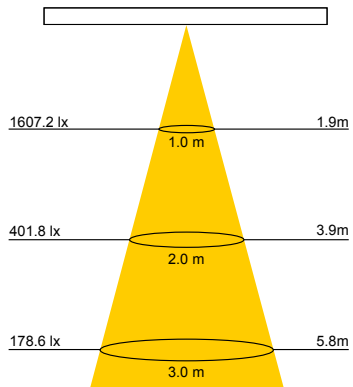





**DOWNLIGHT 220-240V DIMMERABILE Ø 170**

NEW

CATEGORIA SCONTO 23

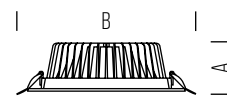

DIMENSIONI	A	B
1	55	170



Driver compreso nella confezione



- Incasso fisso professionale con corpo in alluminio pressofuso alta efficienza 100lm/W
- Lunga durata 50.000h
- Dimmerabile
- Driver elettronico incluso
- Protezione: IP44 frontale (IP20 posteriore ed alimentatore)



POTENZA WATT	EQUIVALENZA WATT	KELVIN	LUMEN LM	LUMEN UTILI	FASCIO °	MISURE MM	CODICE	EAN	IMBALLO	PREZZO € IVA ESCLUSA
24,0	-	3000	2550	-	100	1	<b>LD4DWL2452AD</b>	8031453019433	10	51,00
24,0	-	4000	2550	-	100	1	<b>LD4DWL2453AD</b>	8031453019457	10	51,00

**LD4DWL2452AD**

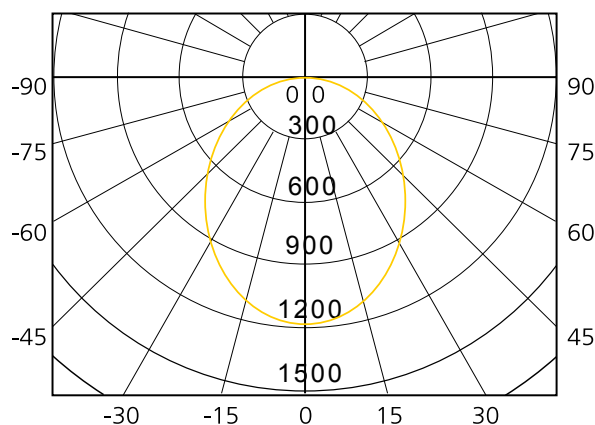
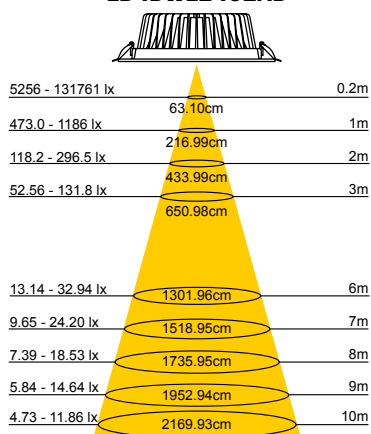

**LD4DWL2453AD**

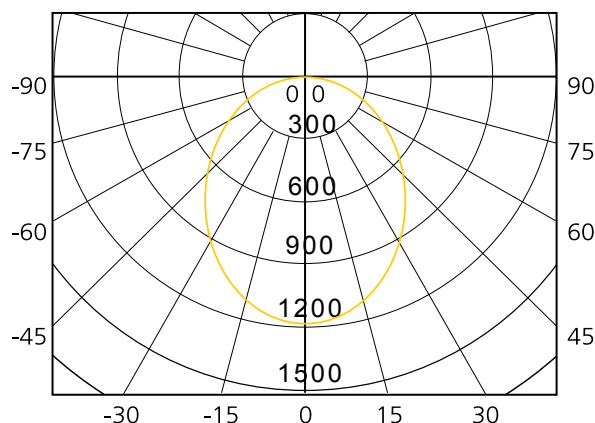
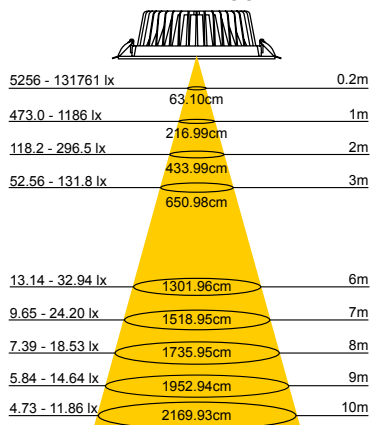

## DOWNLIGHT 220-240V DIMMERABILE Ø 220

NEW

CATEGORIA SCONTO 23

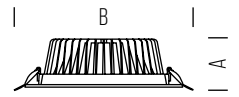

DIMENSIONI	A	B
1	68	220



Driver compreso nella confezione



- Incasso fisso professionale con corpo in alluminio pressofuso alta efficienza 100lm/W
- Lunga durata 50.000h
- Dimmerabile
- Driver elettronico incluso
- Protezione: IP44 frontale (IP20 posteriore ed alimentatore)



POTENZA WATT	EQUIVALENZA WATT	KELVIN	LUMEN LM	LUMEN UTILI	FASCIO °	MISURE MM	CODICE	EAN	IMBALLO	PREZZO € IVA ESCLUSA
24,0	-	3000	2400	-	100	1	<b>LD4DWL2452BD</b>	8031453019440	10	59,00
24,0	-	4000	2400	-	100	1	<b>LD4DWL2453BD</b>	8031453019464	10	59,00

### LD4DWL2452BD

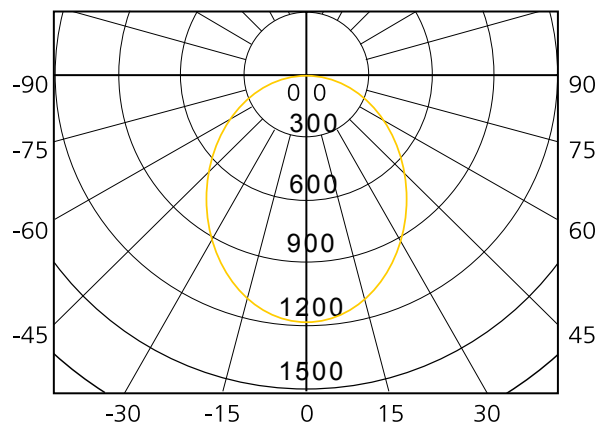
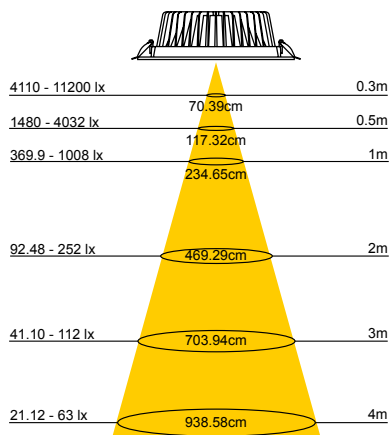

### LD4DWL2453BD

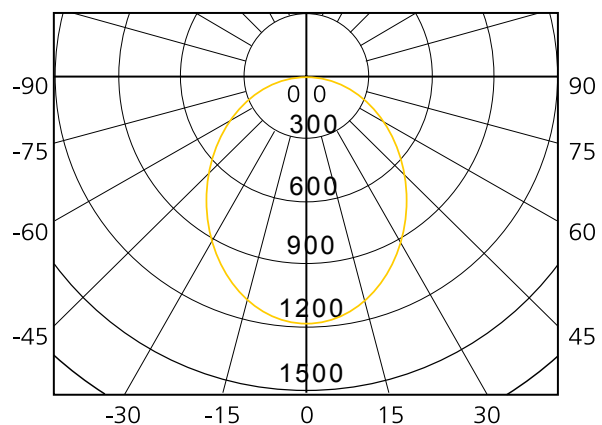
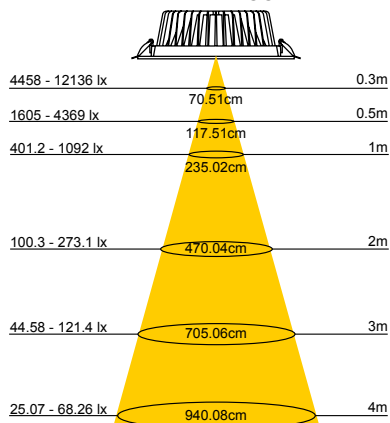

**MODULO LED CRI>90 220-240V DIMMERABILE**

AGGIORNATO

CATEGORIA SCONTO 23

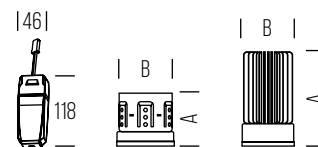
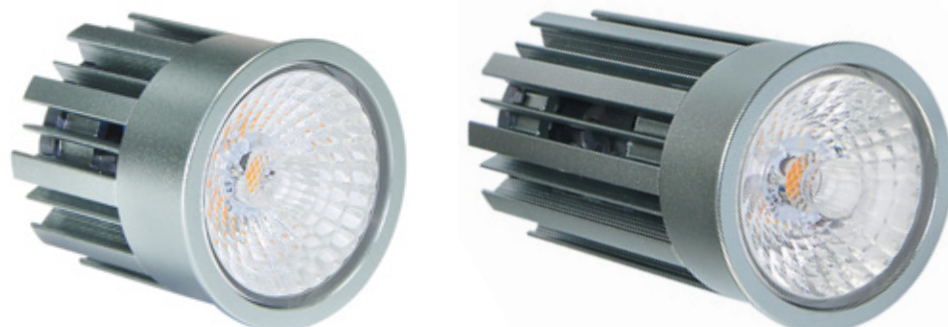

DIMENSIONI	A	B
1	51	50
2	87	50

- Moduli led ed anelli di fissaggio con forme e rifiniture differenti
- Fascio 24° - 38° - 60°
- Driver dimmerabile incluso nella confezione con connettore a sgancio rapido
- Alta resa dei colori (CRI>90)



POTENZA WATT	EQUIVALENZA WATT	KELVIN	LUMEN LM	LUMEN UTILI	CANDELE CD	FASCIO °	MISURE MM	CODICE	EAN	IMBALLO	PREZZO € IVA ESCLUSA
8,5	-	3000	700	660	3050	24	1	LD1SPT0922	8031453005016	20	35,90
8,5	-	3000	700	660	1503	38	1	LD1SPT0923	8031453005030	20	35,90
8,5	-	3000	700	660	735	60	1	LD1SPT0924	8031453005054	20	35,90
12,5	-	3000	1000	900	2000	38	2	LD1SPT1332	8031453006341	20	39,90
12,5	-	3000	1000	900	1200	60	2	LD1SPT1342	8031453006365	20	39,90

**ANELLI DI FISSAGGIO ORIENTABILI CIRCOLARI**
**ANELLI DI FISSAGGIO ORIENTABILI QUADRATI**

LD1SPTA01A



LD1SPTA01B



LD1SPTA01S



LD1SPTA02A



LD1SPTA02B



LD1SPTA02S

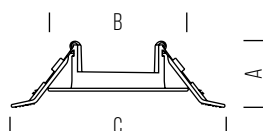

LD1SPTA91B

**ANELLO DI FISSAGGIO FISSO PER AMBIENTI UMIDI CON VETRO FRONTALE IP65**

DIMENSIONI	A	B	C
1	32	90	137

CATEGORIA SCONTO 23



Ø 65-80 MM

COLORE	FORMA	DIAMETRO FORO MM	MISURE MM	CODICE	EAN	IMBALLO	PREZZO € IVA ESCLUSA
ARGENTO	CIRCOLARE	65-80	1	LD1SPTA01A	8031453005078	10	7,30
BIANCO	CIRCOLARE	65-80	1	LD1SPTA01B	8031453005108	10	7,80
METALLO SPAZZOLATO	CIRCOLARE	65-80	1	LD1SPTA01S	8031453005139	10	9,80
ARGENTO	QUADRATO	65-80	1	LD1SPTA02A	8031453005160	10	7,80
BIANCO	QUADRATO	65-80	1	LD1SPTA02B	8031453005191	10	7,50
METALLO SPAZZOLATO	QUADRATO	65-80	1	LD1SPTA02S	8031453005221	10	10,70
BIANCO	CIRCOLARE	65-80	1	LD1SPTA91B	8031453005252	10	8,40

## LD1SPT0922

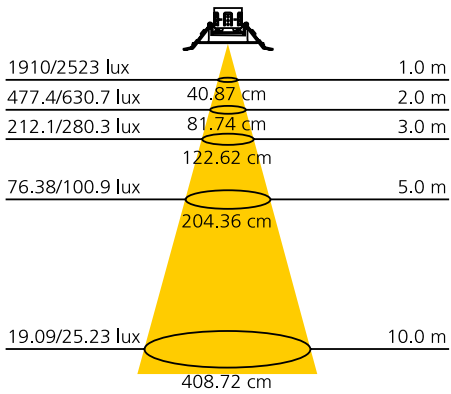

## LD1SPT0923

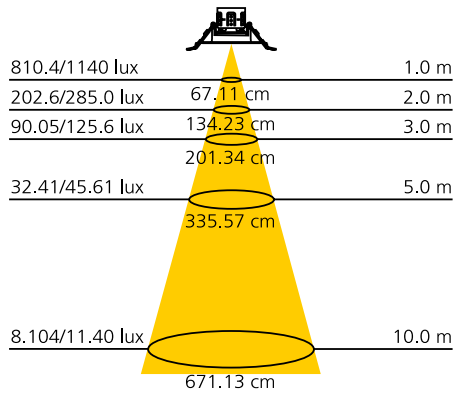

## LD1SPT0924

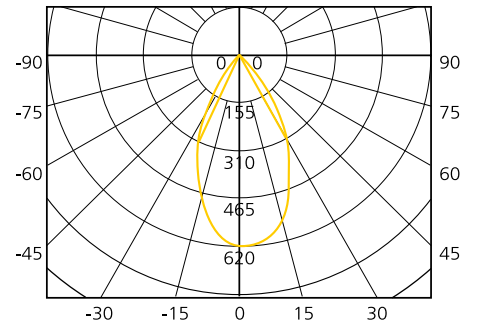
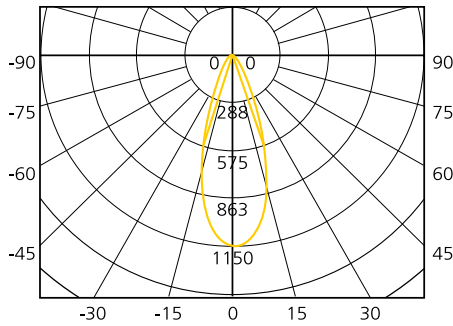
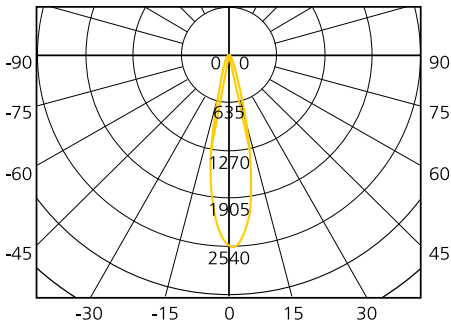
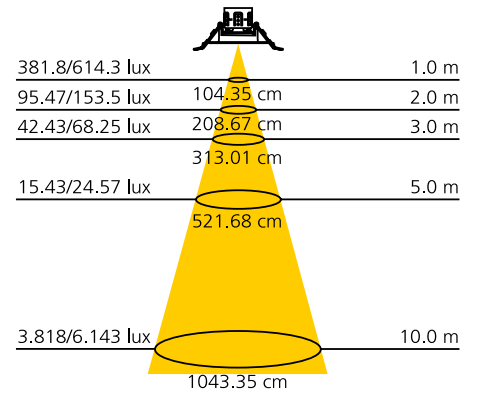

## LD1SPT1332

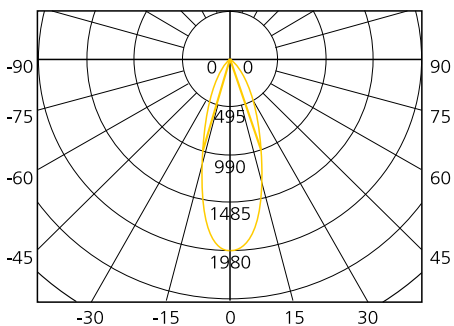
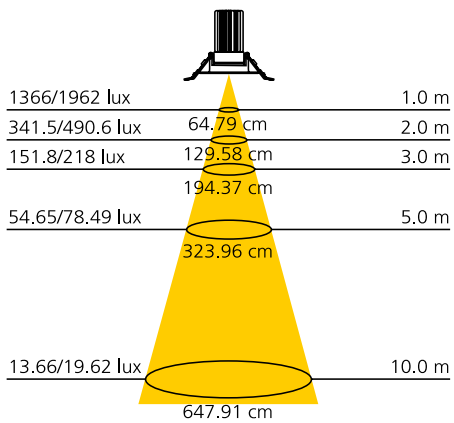

## LD1SPT1342

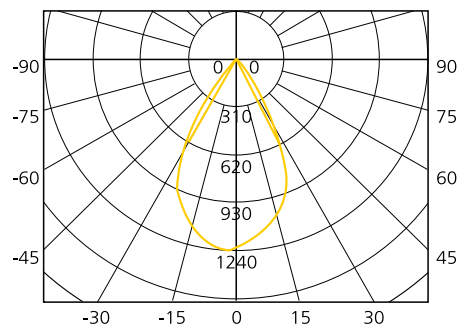
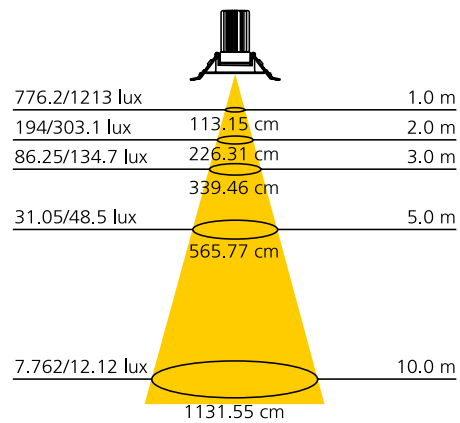

**PROIETTORE PER BINARIO CENTER 220-240V BIANCO**
**NEW**

CATEGORIA SCONTO 23

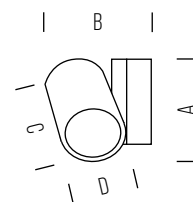

DIMENSIONI	A	B	C	D
1	170	149	130	100

- Proiettore per binario ad alta potenza
- Spotlight per utilizzo in negozi e spazi pubblici
- Disponibili in 2 temperature di colore e 3 fasci (17°-25°-40°)
- Corpo in alluminio verniciato bianco
- Adattatore Global Trac trifase
- Versione opzionale ad alta resa cromatica (CRI>90)



POTENZA WATT	EQUIVALENZA WATT	KELVIN	LUMEN LM	LUMEN UTILI	FASCIO °	MISURE MM	CODICE	EAN	IMBALLO	PREZZO € IVA ESCLUSA
32	-	3000	2800	-	17	1	<b>4116496</b>	6435200218100	12	145,00
32	-	3000	2800	-	25	1	<b>4116497</b>	6435200218117	12	145,00
32	-	3000	2800	-	40	1	<b>4116498</b>	6435200218124	12	145,00
32	-	4000	2900	-	17	1	<b>4118702</b>	6435200218162	12	145,00
32	-	4000	2900	-	25	1	<b>4118703</b>	6435200218179	12	145,00
32	-	4000	2900	-	40	1	<b>4118704</b>	6435200218186	12	145,00

## PROIETTORE PER BINARIO CENTER 220-240V NERO

NEW

CATEGORIA SCONTO 23

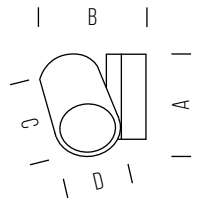
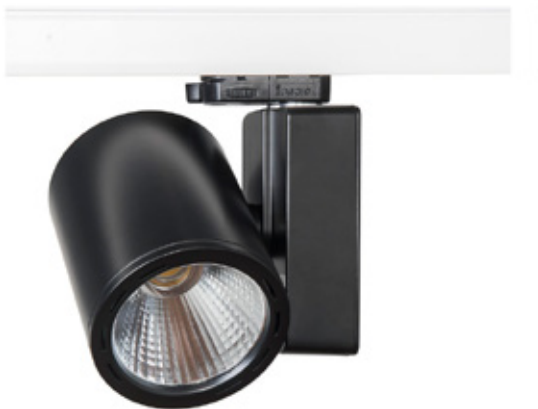

DIMENSIONI	A	B	C	D
1	170	149	130	100

- Proiettore per binario ad alta potenza
- Spotlight per utilizzo in negozi e spazi pubblici
- Disponibili in 2 temperature di colore e 3 fasci (17°-25°-40°)
- Corpo in alluminio verniciato nero
- Adattatore Global Trac trifase
- Versione opzionale ad alta resa cromatica (CRI>90)



POTENZA WATT	EQUIVALENZA WATT	KELVIN	LUMEN LM	LUMEN UTILI	FASCIO °	MISURE MM	CODICE	EAN	IMBALLO	PREZZO € IVA ESCLUSA
32	-	3000	2800	-	17	1	<b>4116499</b>	6435200218131	12	145,00
32	-	3000	2800	-	25	1	<b>4118700</b>	6435200218148	12	145,00
32	-	3000	2800	-	40	1	<b>4118701</b>	6435200218155	12	145,00
32	-	4000	2900	-	17	1	<b>4118705</b>	6435200218193	12	145,00
32	-	4000	2900	-	25	1	<b>4118706</b>	6435200218209	12	145,00
32	-	4000	2900	-	40	1	<b>4118707</b>	6435200218216	12	145,00

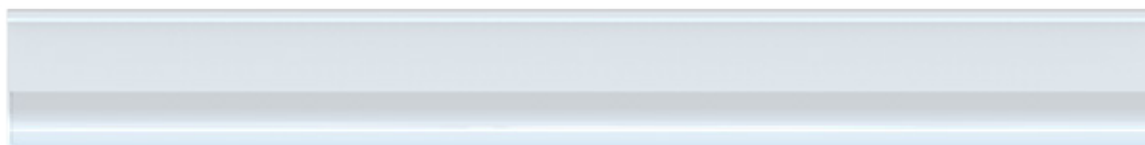

DIMENSIONI	A	B	C
1	36	300	23
2	36	600	23
3	36	1200	23

- Sistema modulare a led componibile per creare una linea di luce senza interruzioni
- Possibilità di unire elementi fino a 9 metri con connettore e cavetto inclusi
- Possibilità di creare curve con connettori a "L" "T" "X"
- Disponibile in tre diverse lunghezze e due colorazioni



POTENZA WATT	EQUIVALENZA WATT	BASE	KELVIN	LUMEN LM	CANDELE CD	FASCIO °	MISURE MM	CODICE	EAN	IMBALLO	PREZZO € IVA ESCLUSA
5,0	-	-	3000	400	-	120	1	LD2BAR052	8031453012632	10	8,90
5,0	-	-	4000	450	-	120	1	LD2BAR053	8031453012663	10	8,90
10,0	-	-	3000	950	-	120	2	LD2BAR102	8031453011789	10	11,10
10,0	-	-	4000	1050	-	120	2	LD2BAR103	8031453011819	10	11,10
20,0	-	-	3000	1900	-	120	3	LD2BAR202	8031453012328	10	17,00
20,0	-	-	4000	2000	-	120	3	LD2BAR203	8031453012359	10	17,00

**ACCESSORI**

CATEGORIA SCONTO 23



INCLUSI



OPZIONALI

POTENZA WATT	EQUIVALENZA WATT	BASE	KELVIN	LUMEN LM	CANDELE CD	FASCIO °	MISURE MM	CODICE	EAN	IMBALLO	PREZZO € IVA ESCLUSA
								LD2BARLC	8031453012021	100	1,70
								LD2BARTC	8031453012052	100	2,15
								LD2BARXC	8031453011994	100	2,50



### LD2BAR052

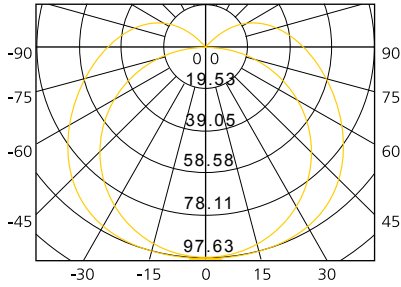
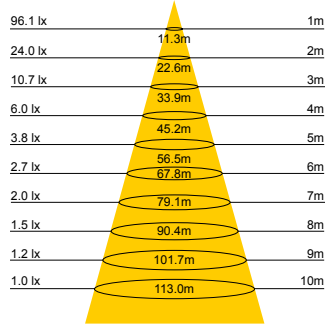

### LD2BAR053

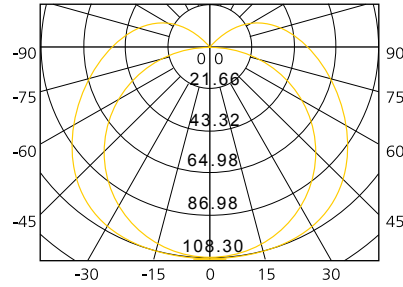
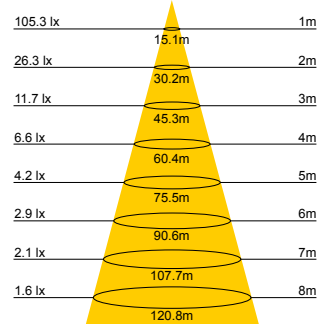

### LD2BAR102

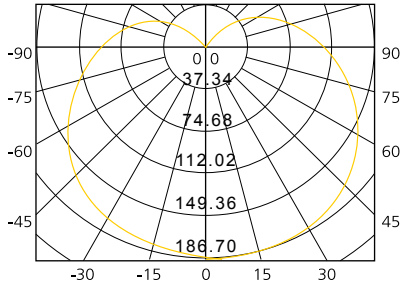
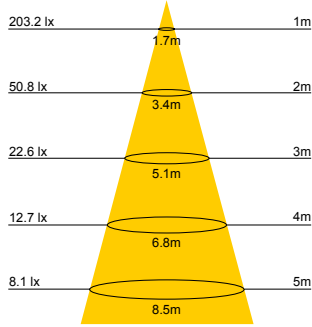

### LD2BAR103

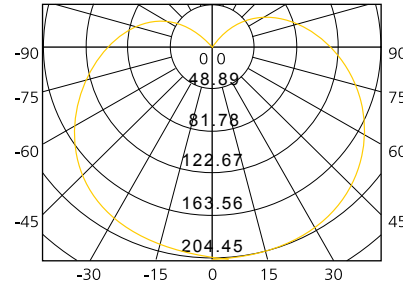
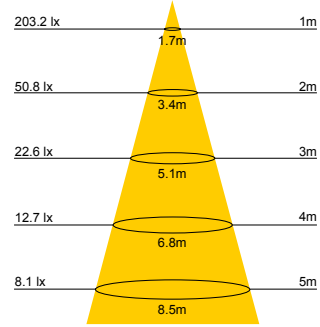

### LD2BAR202

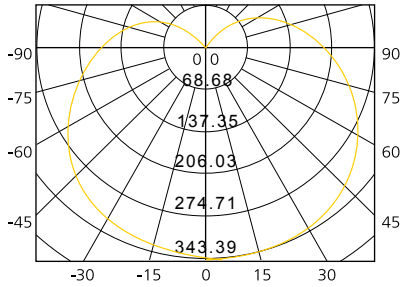
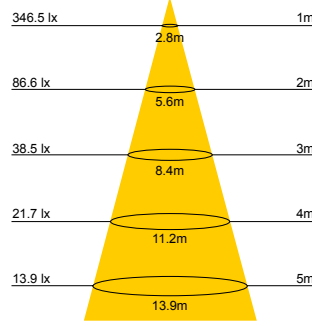

### LD2BAR203

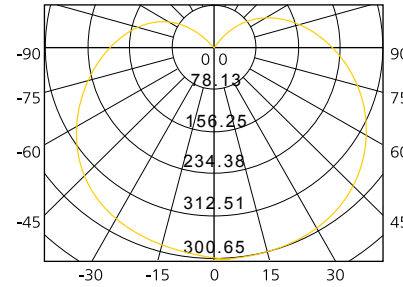
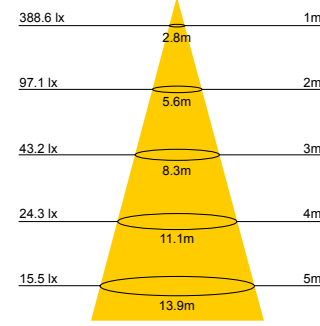

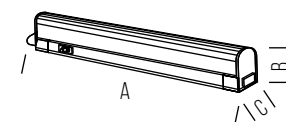

DIMENSIONI	A	B	C
1	288	36	28
2	516	36	28
3	849	36	28
4	1149	36	28
5	1449	36	28

- Gamma completa di reglette a led con interruttore per sostituzione delle tradizionali reglette T5
- Disponibile luce 3000K/4000K – disponibili in cinque potenze e misure
- Cavo di alimentazione da 1800mm e cavo di interconnessione da 150mm inclusi
- Possibilità di collegamento in serie fino a 12 pezzi
- Isolamento classe 2



POTENZA WATT	EQUIVALENZA WATT	BASE	KELVIN	LUMEN LM	CANDELE CD	FASCIO °	MISURE MM	CODICE	EAN	IMBALLO	PREZZO € IVA ESCLUSA
4,0	-	-	3000	320	-	120	1	<b>YGS042B</b>	8031453006853	10	13,60
4,0	-	-	4000	350	-	120	1	<b>YGS043B</b>	8031453006877	10	13,60
7	-	-	3000	600	-	120	2	<b>YGS072B</b>	8031453006891	10	16,30
7,0	-	-	4000	630	-	120	2	<b>YGS073B</b>	8031453006914	10	16,30
13,0	-	-	3000	1100	-	120	3	<b>YGS132B</b>	8031453006938	10	21,00
13,0	-	-	4000	1150	-	120	3	<b>YGS133B</b>	8031453006952	10	21,00
18,0	-	-	3000	1580	-	120	4	<b>YGS182B</b>	8031453006976	10	24,30
18,0	-	-	4000	1550	-	120	4	<b>YGS183B</b>	8031453007201	10	24,30
22,0	-	-	3000	1920	-	120	5	<b>YGS222B</b>	8031453007683	10	28,60
22,0	-	-	4000	2000	-	120	5	<b>YGS223B</b>	8031453007706	10	28,60

COMPRESO DI CAVO DI ALIMENTAZIONE DA 1800MM E CAVO DI INTERCONNESSIONE DA 150 MM

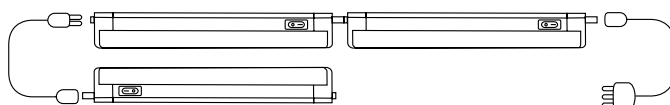

MAX 12 PEZZI COLLEGATI IN SERIE



**YGS042B**

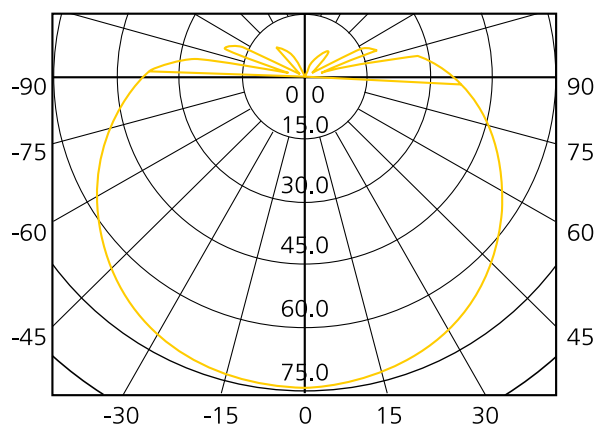
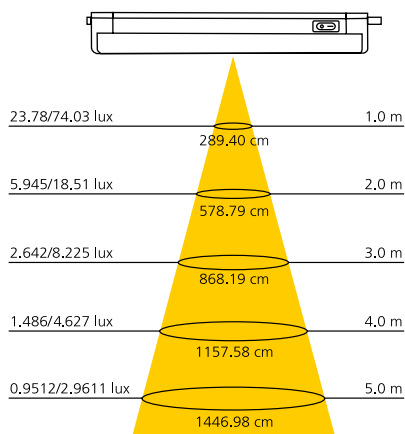

## YGS043B

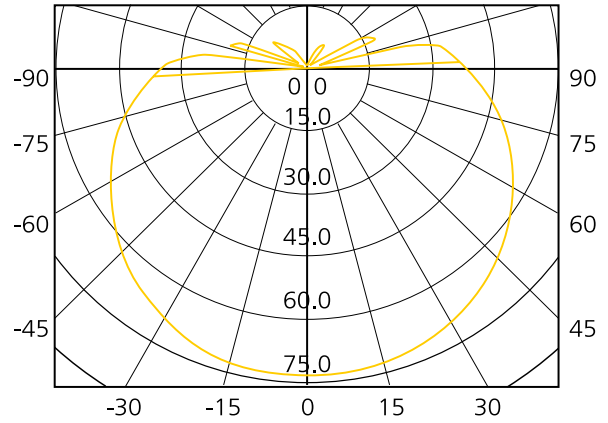
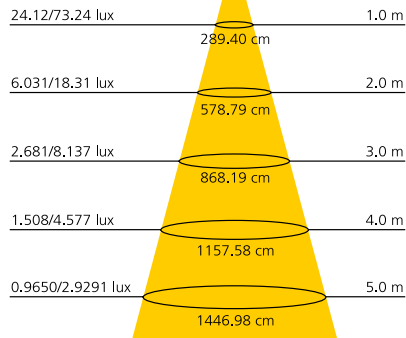
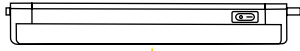

## YGS072B

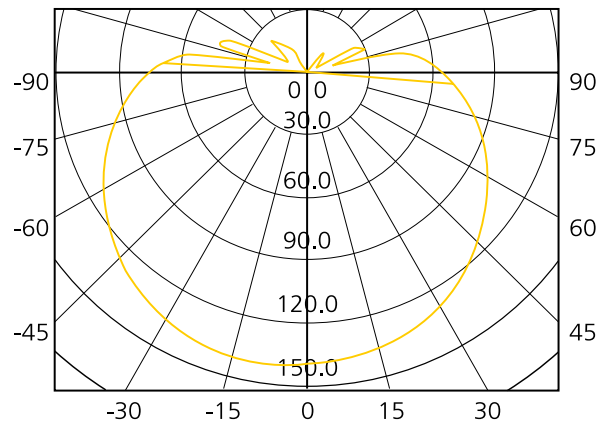
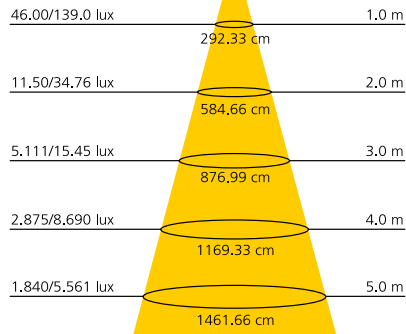
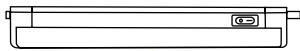

## YGS073B

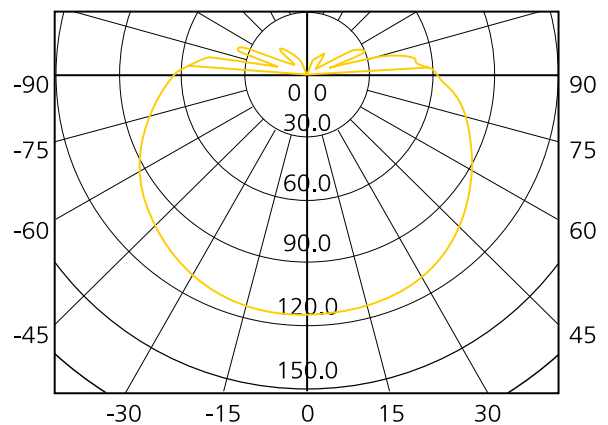
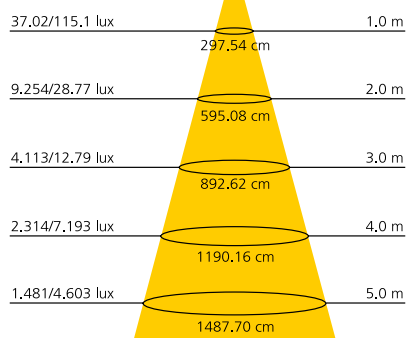
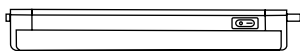

### YGS132B

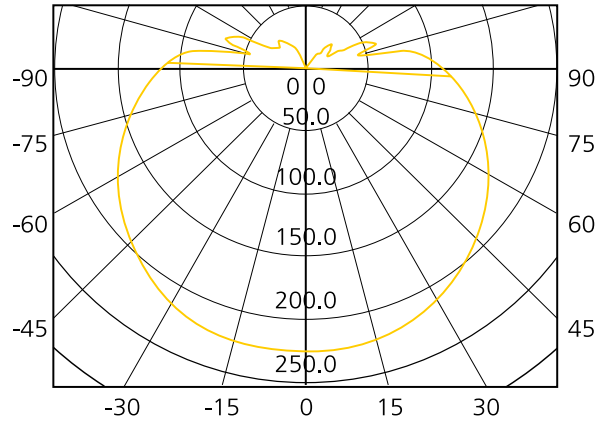
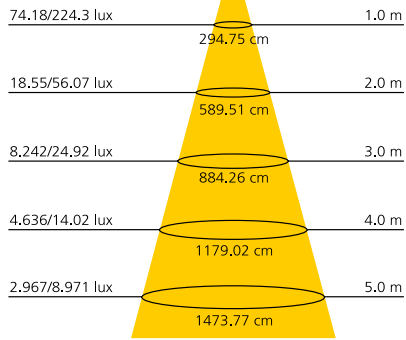
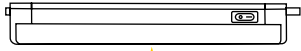

### YGS133B

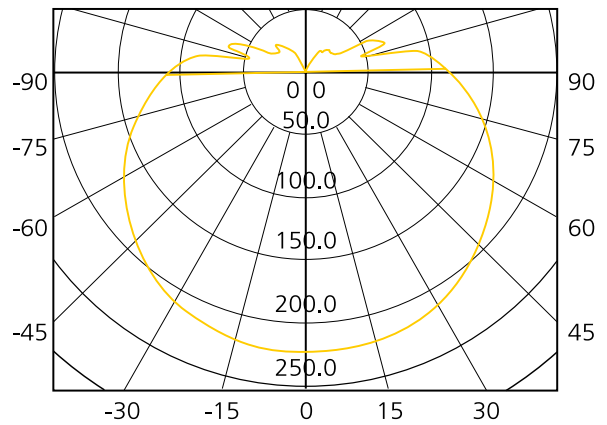
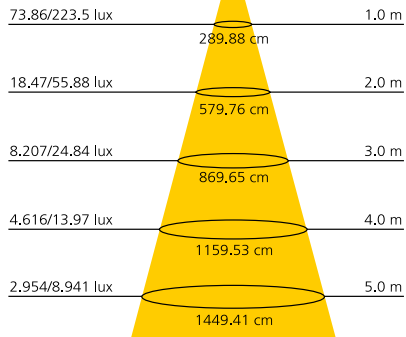
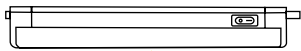

### YGS182B

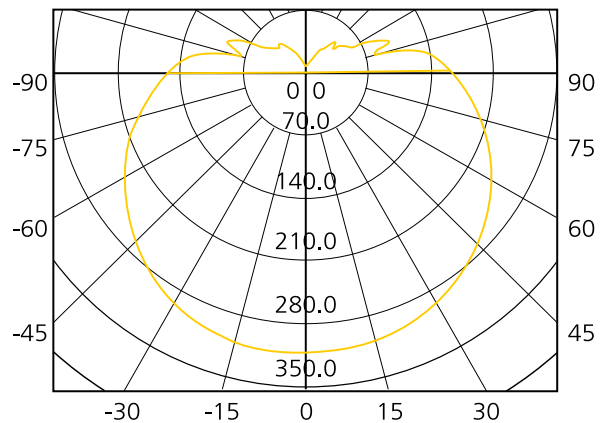
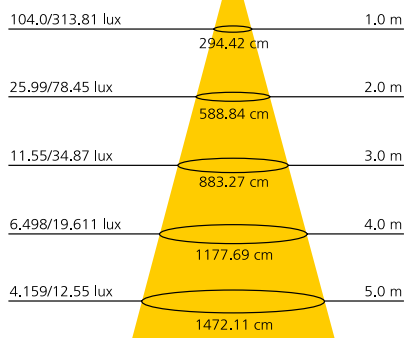
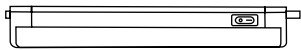

## YGS183B

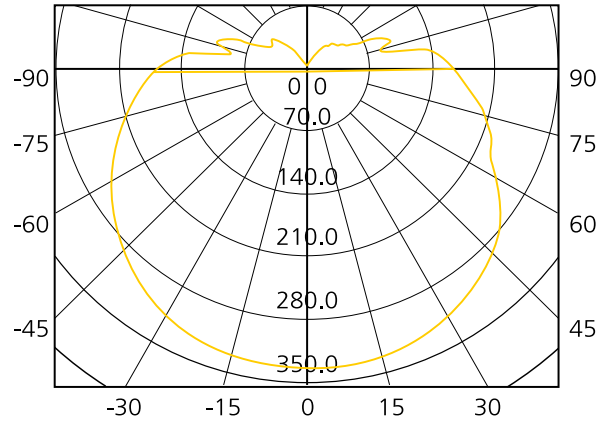
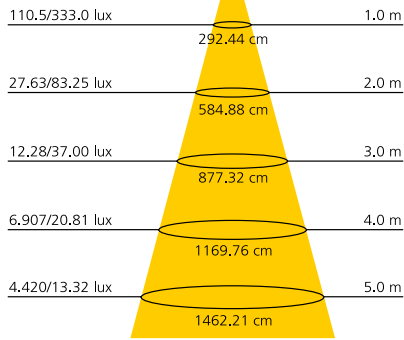
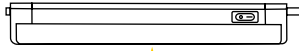

## YGS222B

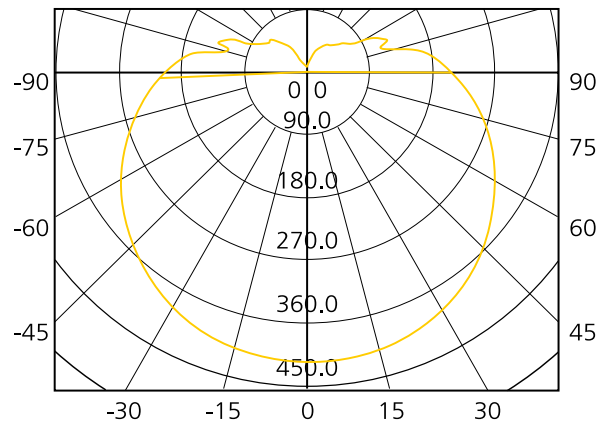
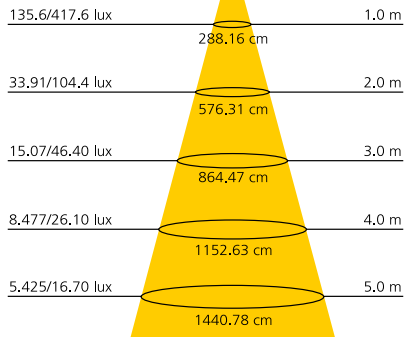
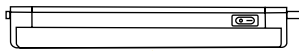

## YGS223B

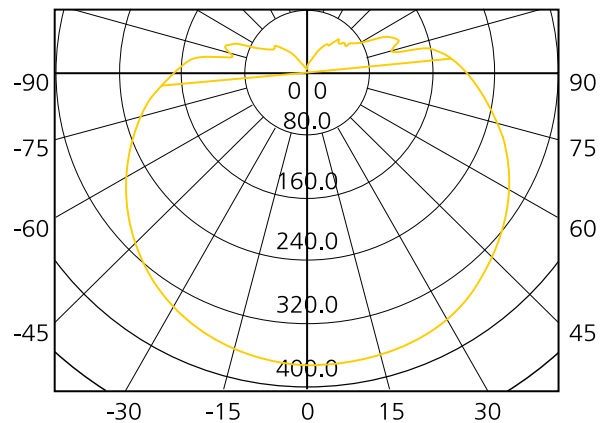
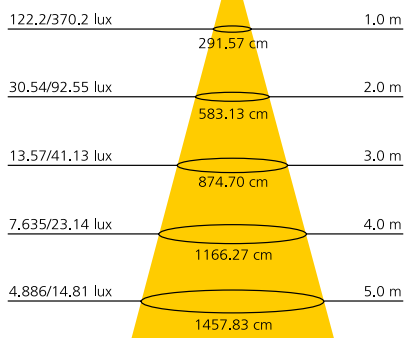
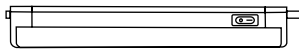



## SISTEMA DI ILLUMINAZIONE A STRIP LED 12V

CATEGORIA SCONTO 23

- Strisce a led adesive (tranne versioni IP67) ad alta potenza con alimentazione a 12V DC
- Lunghezza del rotolo 5 metri, striscia ritagliabile ogni 5 cm.
- Driver ad alta efficienza con carico max 6W-15W-30W-60W-75W da ordinare separatamente
- Opzionali cavetti di alimentazione, connettori di interconnessione, accessori per il montaggio
- Protezione: IP20 – IP65 – IP67



POTENZA WATT	LUMEN LM	KELVIN	NUMERO LED	IP	MISURE MM	CODICE	EAN	IMBALLO	PREZZO € IVA ESCLUSA
24	320 X METRO	3000	300	20	5000 X 8 X 3	LD1STR242IP20	8031453002527	1	32,30
24	320 X METRO	4000	300	20	5000 X 8 X 3	LD1STR243IP20	8031453002534	1	32,30
48	660 X METRO	3000	600	20	5000 X 8 X 3	LD1STR482IP20	8031453002541	1	52,00
48	660 X METRO	4000	600	20	5000 X 8 X 3	LD1STR483IP20	8031453002558	1	52,00
72	1100 X METRO	3000	300	65	5000 X 12 X 3	LD1STR722IP65	8031453001841	1	69,00
72	1100 X METRO	4000	300	65	5000 X 12 X 3	LD1STR723IP65	8031453001865	1	69,00
72	1100 X METRO	3000	300	67	5000 X 12 X 3	LD1STR722IP67	8031453001858	1	71,00
72	1100 X METRO	4000	300	67	5000 X 12 X 3	LD1STR723IP67	8031453001872	1	71,00

## SISTEMA DI ILLUMINAZIONE A STRIP LED 24V

NEW

CATEGORIA SCONTO 23

- Strisce a led adesive ad alta potenza con alimentazione a 24V DC
- Lunghezza del rotolo 5 metri, striscia ritagliabile ogni 5 cm.
- Driver ad alta efficienza con carico max 6W-15W-30W-60W-75W da ordinare separatamente
- Opzionali cavetti di alimentazione, connettori di interconnessione, accessori per il montaggio
- Protezione: IP20 – IP65



POTENZA WATT	LUMEN LM	KELVIN	NUMERO LED	IP	MISURE MM	CODICE	EAN	IMBALLO	PREZZO € IVA ESCLUSA
24	500 X METRO	3000	300	20	5000	LD2STR242IP20	8031453019235	1	28,70
24	500 X METRO	4000	300	20	5000	LD2STR243IP20	8031453019242	1	28,70
48	1000 X METRO	3000	600	20	5000	LD2STR482IP20	8031453019259	1	41,50
48	1000 X METRO	4000	600	20	5000	LD2STR483IP20	8031453019266	1	41,50
70	1300 X METRO	3000	300	65	5000	LD2STR722IP65	8031453019273	1	62,00
70	1300 X METRO	4000	300	65	5000	LD2STR723IP65	8031453019280	1	62,00

DRIVER PER STRIP LED 12V	IP	MISURE MM	CODICE	EAN	IMBALLO	PREZZO € IVA ESCLUSA
Led driver 12V DC - 6 Watt Max	-	82 X 43 X 23	<b>LD1STRD06</b>	8031453002565	10	10,30
Led driver 12V DC - 15 Watt Max	-	123 X 45 X 19	<b>LD1STRD15</b>	8031453001889	10	13,50
Led driver 12V DC - 30 Watt Max	-	166 X 52 X 24	<b>LD1STRD30</b>	8031453001896	10	24,30
Led driver 12V DC - 60 Watt Max	-	180 X 52 X 30	<b>LD1STRD60</b>	8031453001902	10	35,00
Led driver 12V DC - 75 Watt Max	-	180 X 52 X 30	<b>LD1STRD75</b>	8031453002572	10	42,50

DRIVER PER STRIP LED 24V	IP	MISURE MM	CODICE	EAN	IMBALLO	PREZZO € IVA ESCLUSA
<b>NEW</b> Led driver 24V DC - 6 Watt Max	-	82 X 43 X 23	<b>LD2STRD06</b>	8031453019419	10	10,90
<b>NEW</b> Led driver 24V DC - 15 Watt Max	-	123 X 45 X 19	<b>LD2STRD15</b>	8031453019426	10	11,20
<b>NEW</b> Led driver 24V DC - 30 Watt Max	-	166 X 52 X 24	<b>LD2STRD30</b>	8031453019297	10	23,80
<b>NEW</b> Led driver 24V DC - 60 Watt Max	-	180 X 52 X 30	<b>LD2STRD60</b>	8031453019303	10	28,70
<b>NEW</b> Led driver 24V DC - 75 Watt Max	-	180 X 52 X 30	<b>LD2STRD75</b>	8031453019310	10	31,50

ACCESSORI PER STRIP LED	IP	MISURE MM	CODICE	EAN	IMBALLO	PREZZO € IVA ESCLUSA
* Cavetto di alimentazione per LED Strip 24-48W	20	-	<b>LD1STRCA1</b>	8031453002596	1X5 PZ	5,70
* Cavetto di connessione per LED Strip 24-48W	20	-	<b>LD1STRCC1</b>	8031453002589	1X5 PZ	10,20
* Cavetto di alimentazione small per LED Strip 72W	20	-	<b>LD1STRCA2</b>	8031453003005	1X5 PZ	5,70
* Cavetto di interconnessione small per LED Strip 72W	20	-	<b>LD1STRCC2</b>	8031453003012	1X5 PZ	10,20
* Connettore di interconnessione small senza cavo per LED Strip 72W	20	-	<b>LD1STRCC3</b>	8031453003135	1X5 PZ	9,60
** Sacchetto di accessori comprendente 20 clips per il fissaggio delle strisce e 5 caps di isolamento connettori per strisce led IP65	-	-	<b>LD1STRSACIP65</b>	8031453002121	1	4,20
** Sacchetto di accessori comprendente 20 clips per il fissaggio delle strisce e 5 caps di isolamento connettori per strisce led IP67	-	-	<b>LD1STRSACIP67</b>	8031453002138	1	4,20

\* Carico max 70W(24V) – 35W(12V)

\*\* L'utilizzo dei caps di isolamento e dei cavi di interconnessione non garantiscono il grado IP iniziale delle strisce, pertanto si consiglia in abbinata a tali accessori di attuare degli accorgimenti tali (isolamento con silicone o altri sistemi) da poter considerare l'installazione di grado IP adeguato al luogo dove viene realizzata.

**MODULO LED CIRCOLARE MAGNETICO 200-240V**

**NEW**  
CATEGORIA SCONTO 23

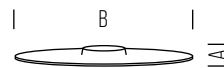

DIMENSIONI	A	B
1	27	125
2	27	165
3	27	180

- Modulo a LED con alimentatore incorporato per retrofit su plafoniere esistenti.
- Installazione rapida grazie a supporti magnetici, necessita solo del collegamento dell'alimentazione (isolamento classe II)
- Disponibili diverse misure e potenze per adattarsi ai diversi apparecchi esistenti



POTENZA WATT	EQUIVALENZA WATT	KELVIN	LUMEN LM	LUMEN UTILI	FASCIO °	MISURE MM	CODICE	EAN	IMBALLO	PREZZO € IVA ESCLUSA
12	-	3000	1200	-	160	1	<b>MODA122</b>	8031453019563	1	8,90
12	-	4000	1200	-	160	1	<b>MODA123</b>	8031453019570	1	8,90
20	-	3000	2000	-	160	2	<b>MODA202</b>	8031453019587	1	11,60
20	-	4000	2000	-	160	2	<b>MODA203</b>	8031453019594	1	11,60
24	-	3000	2400	-	160	3	<b>MODA242</b>	8031453019600	1	13,40
24	-	4000	2400	-	160	3	<b>MODA243</b>	8031453019617	1	13,40

**MODA122 - MODA123**

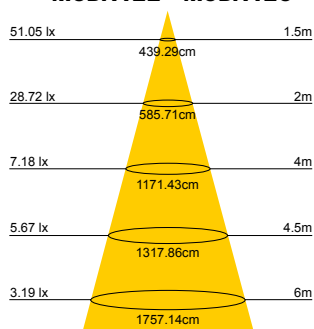

**MODA202 - MODA203**

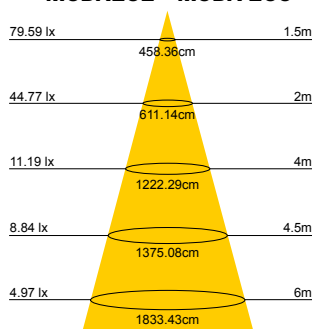

**MODA242 - MODA243**

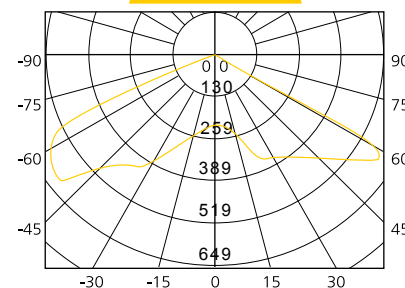
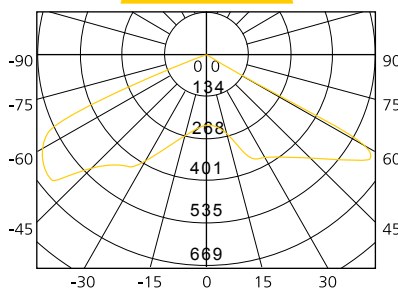
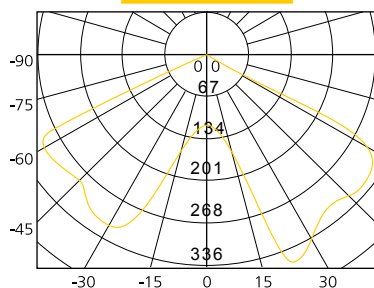
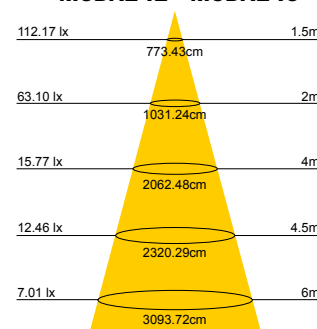



## MODULO LED CIRCOLARE MAGNETICO 200-240V

NEW

CATEGORIA SCONTO 23



	I	B	I
	-----		-----
DIMENSIONI	A	B	
1	27	220	

- Modulo a LED con alimentatore incorporato per retrofit su plafoniere esistenti.
- Installazione rapida grazie a supporti magnetici, necessita solo del collegamento dell'alimentazione (isolamento classe II)
- Versione con foro centrale, ideale per sostituzione in plafoniere con foro passante



POTENZA WATT	EQUIVALENZA WATT	KELVIN	LUMEN LM	LUMEN UTILI	FASCIO °	MISURE MM	CODICE	EAN	IMBALLO	PREZZO € IVA ESCLUSA
20	-	3000	2000	-	120	1	MODB202	8031453019624	1	12,50
20	-	4000	2000	-	120	1	MODB203	8031453019631	1	12,50

### MODB242 - MODB243

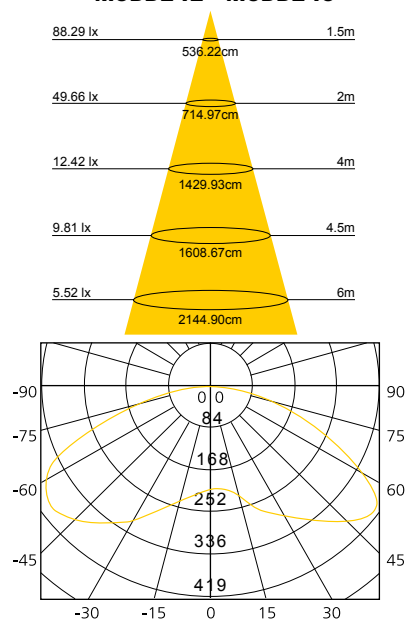

## PLAFONIERA COCO 220-240V

CATEGORIA SCONTO 23

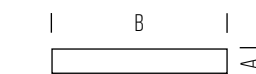

DIMENSIONI	A	B
1	85	250
2	85	300
3	85	350

  

DIMENSIONI CON ANELLO	A	B
1	85	261
2	85	311
3	85	361

- Plafoniera in policarbonato per applicazioni a soffitto e parete
- Personalizzabile con anello di colore grigio già incluso nella confezione
- Disponibili diverse potenze e diametri
- Flusso luminoso uniforme



POTENZA WATT	EQUIVALENZA WATT	BASE	KELVIN	LUMEN LM	CANDELE CD	FASCIO °	MISURE MM	CODICE	EAN	IMBALLO	PREZZO € IVA ESCLUSA
10	-	-	3000	700	215	120	1	<b>COCO102</b>	8031453015213	5	22,00
16	-	-	3000	1100	348	120	2	<b>COCO162</b>	8031453015237	5	28,00
16	-	-	4000	1200	348	120	2	<b>COCO163</b>	8031453015251	5	28,00
21	-	-	3000	1500	458	120	3	<b>COCO212</b>	8031453015275	5	36,00

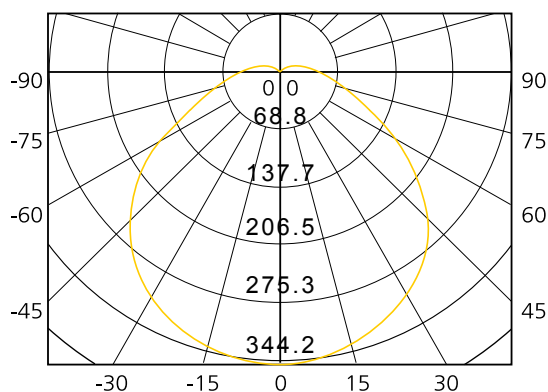
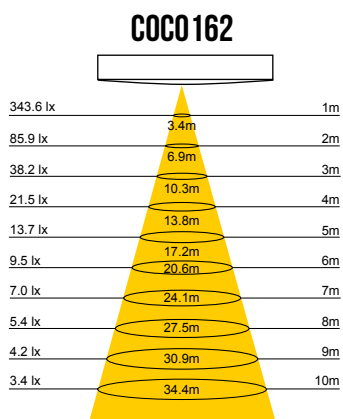
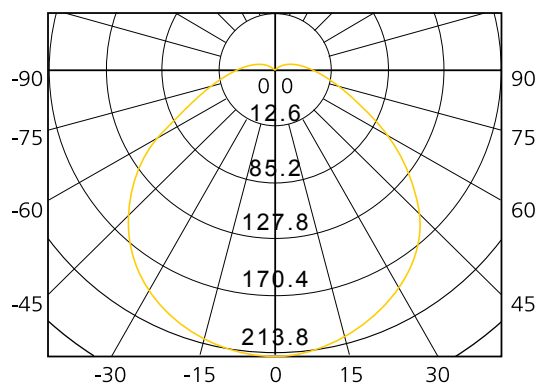
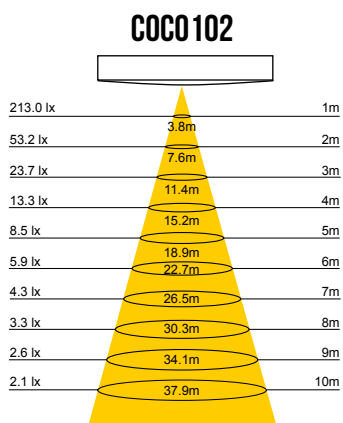

## COCO163

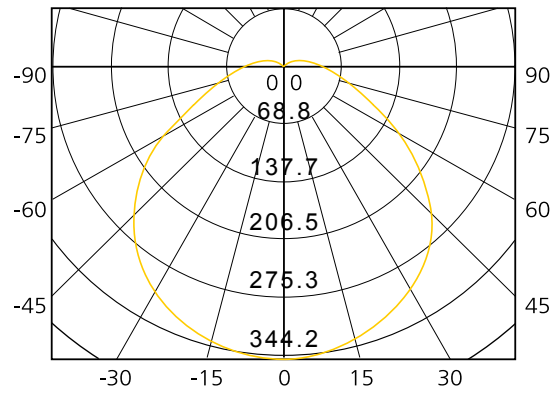
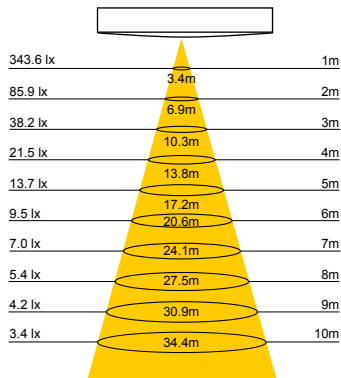

## COCO212

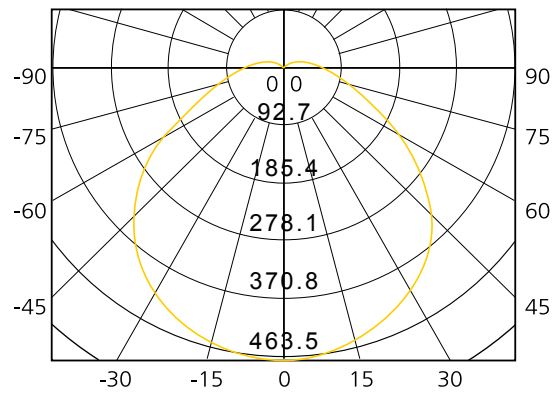
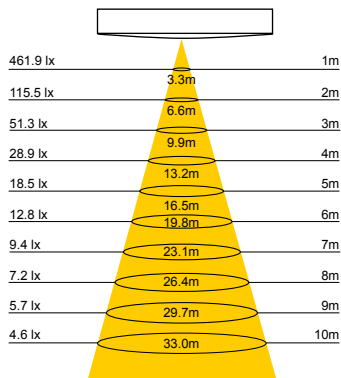

**PLAFONIERA RIO 220-240V**

CATEGORIA SCONTO 23

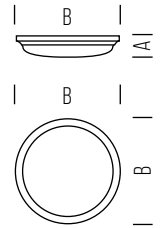

DIMENSIONI	A	B
1	80	305
2	88	400

- Plafoniera in policarbonato versatile e di facile installazione (ad esempio per bagni, garage, corridoi, scale, etc.)
- Disponibile in due diverse dimensioni con CCT 3000K (12W anche CCT 4000K)
- Temperatura d'esercizio: -30° +45°



POTENZA WATT	EQUIVALENZA WATT	BASE	KELVIN	LUMEN LM	CANDELE CD	FASCIO °	MISURE MM	CODICE	EAN	IMBALLO	PREZZO € IVA ESCLUSA
12	-	-	3000	1000	-	-	1	<b>4116137</b>	6435200193445	6	45,50
12	-	-	4000	1000	-	-	1	<b>4116170</b>	6435200194237	6	45,50
20	-	-	3000	1600	-	-	2	<b>4116164</b>	6435200193452	6	66,70

**4116137 / 4116170**

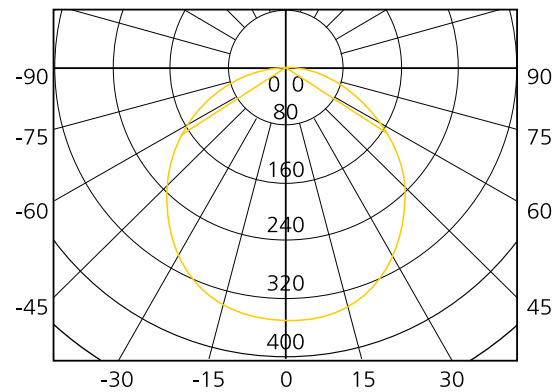
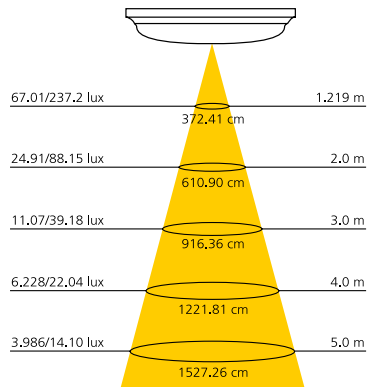

**4116164**

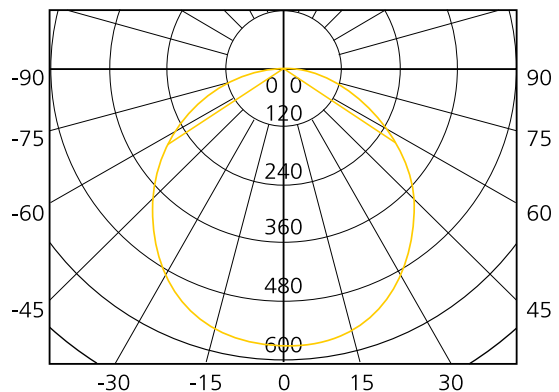
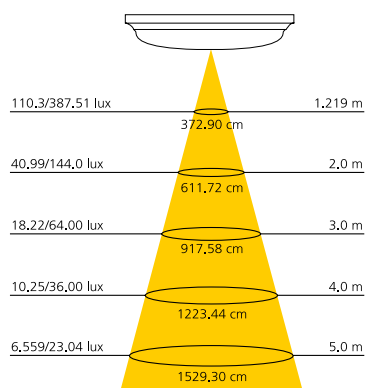

## PLAFONIERA RIO RADAR 220-240V

CATEGORIA SCONTO 23

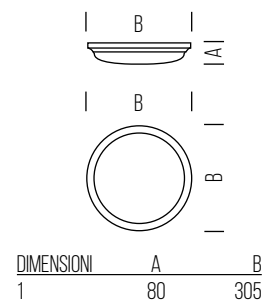
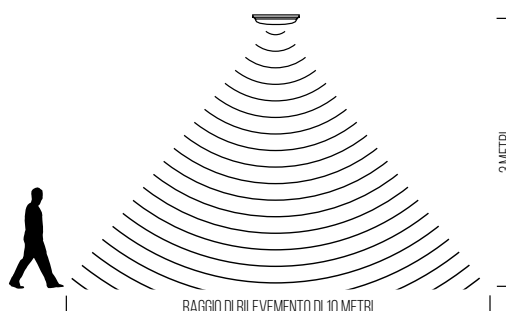

- Plafoniera in policarbonato versatile e di facile installazione (ad esempio per bagni, garage, corridoi, scale, etc.)
- Versione con sensore di movimento a microonde regolabile:
  - Luce ambiente: 2-50 lux - disabilitato
  - Distanza di rilevamento: 2-10m
  - Tempo di accensione: 5sec - 30min
- Altezza di installazione: 2-3m
- Temperatura d'esercizio: -30° +45°



POTENZA WATT	EQUIVALENZA WATT	BASE	KELVIN	LUMEN LM	CANDELE CD	FASCIO °	MISURE MM	CODICE	EAN	IMBALLO	PREZZO € IVA ESCLUSA
12	-	-	3000	1000	-	-	1	4116165	6435200193469	6	71,00

**4116165**

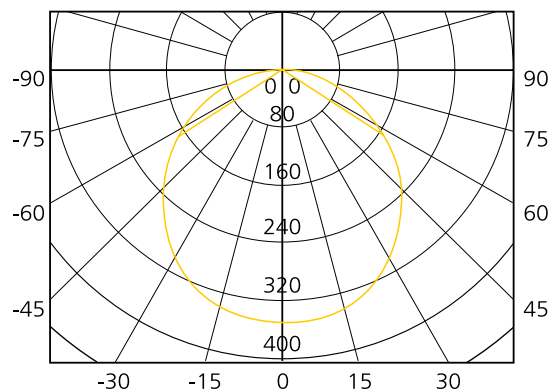
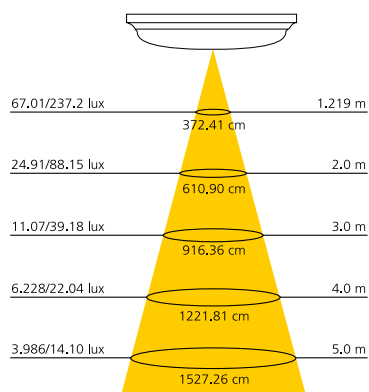

**PLAFONIERA SONO III PIR 220-240V**
**NEW**

CATEGORIA SCONTO 23

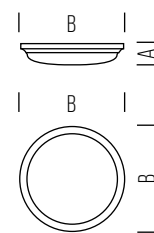

DIMENSIONI	A	B
1	80	305

- Plafoniera in policarbonato particolarmente indicata per frequenti accensioni e spegnimenti
- Sensore di presenza PIR con sistema master/slave. Pilota un carico fino a 400W.
- Regolazioni del sensore:
  - Tempo di accensione: 15s – 8min
  - Distanza di rilevamento: 2-8 m
  - Luminosità ambientale: 3-2000 lux
- Altezza di installazione: 2-3 m
- Temperatura d'esercizio -30° +45°

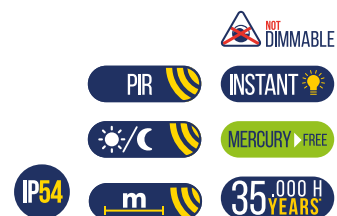

POTENZA WATT	EQUIVALENZA WATT	BASE	KELVIN	LUMEN LM	CANDELE CD	FASCIO °	MISURE MM	CODICE	EAN	IMBALLO	PREZZO € IVA ESCLUSA
15	-	-	3500	1300	-	-	1	<b>4116463</b>	6435200216410	5	73,00

## PLAFONIERA PRIMO 220-240V

CATEGORIA SCONTO 23

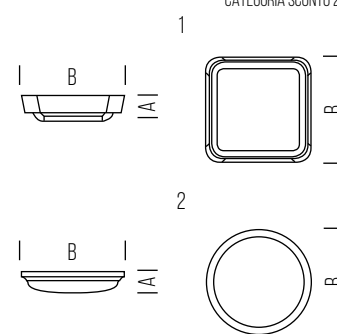

DIMENSIONI	A	B
1	51	200
2	51	200

- Plafoniera bianca con corpo in alluminio
- 8W 3000K disponibile modello rotondo o quadrato
- Adatto al montaggio in spazi angusti o come punto luce



POTENZA WATT	EQUIVALENZA WATT	BASE	KELVIN	LUMEN LM	CANDELE CD	FASCIO °	MISURE MM	CODICE	EAN	IMBALLO	PREZZO € IVA ESCLUSA
8	-	-	3000	600	-	-	1	4116190	6435200202345	8	27,40
8	-	-	3000	600	-	-	2	4116191	6435200202369	8	27,40

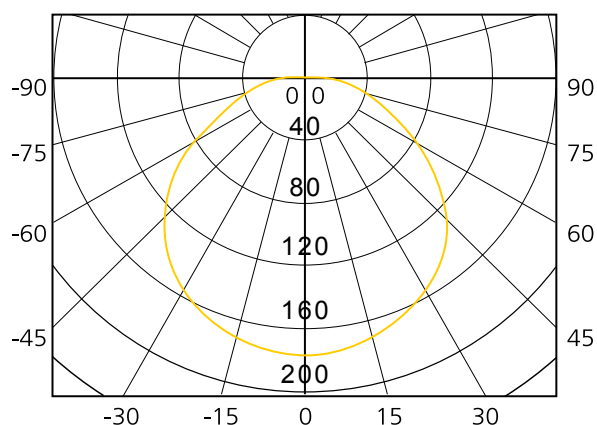
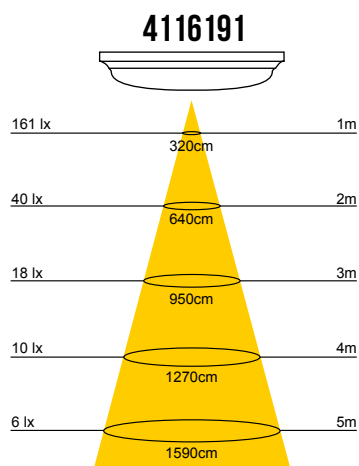
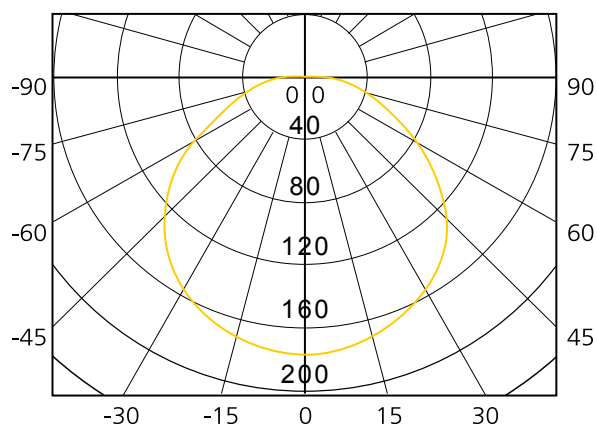
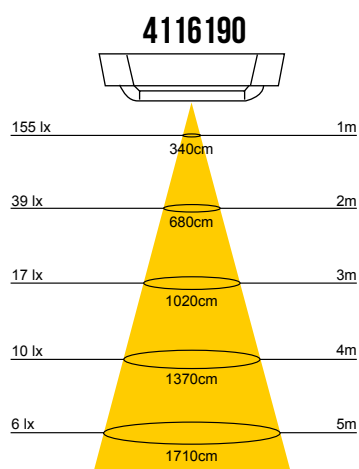

**PLAFONIERA AMBRA CIRCOLARE 220-240V**

**NEW**  
CATEGORIA SCONTO 24

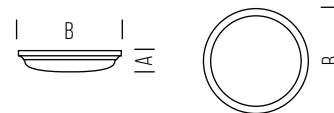

DIMENSIONI	A	B
1	36	140
2	40	180

- Plafoniera rotonda in fusione d'alluminio di facile installazione ideale per applicazioni esterne (es. sottoportici etc...)
- Installazione parete/soffitto



POTENZA WATT	EQUIVALENZA WATT	BASE	KELVIN	LUMEN LM	CANDELE CD	FASCIO °	MISURE MM	CODICE	EAN	IMBALLO	PREZZO € IVA ESCLUSA
10,0	-	-	4000	700	-	110	1	<b>AMBRA10BC</b>	8031453015640	10	28,30
20,0	-	-	4000	1400	-	110	2	<b>AMBRA20BC</b>	8031453019501	10	39,00

**AMBRA10BC**

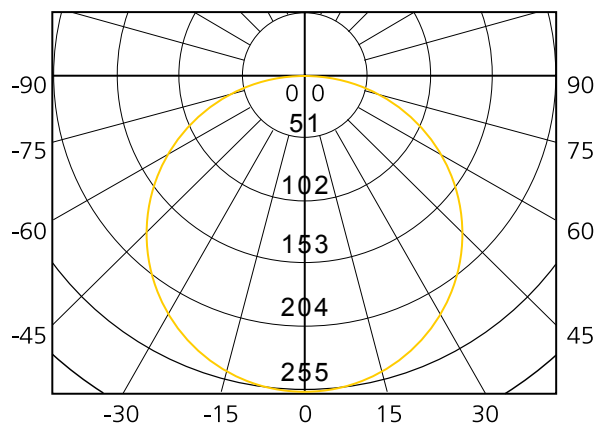
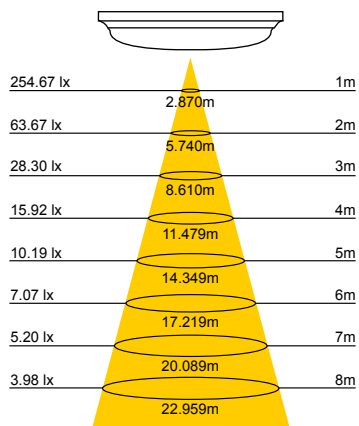

**AMBRA20BC**

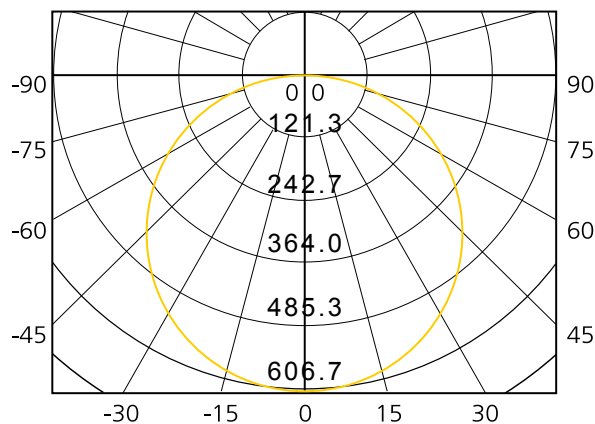
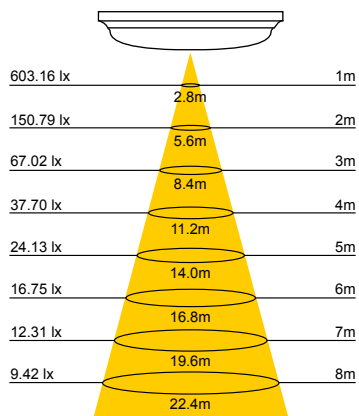



## PLAFONIERA AMBRA QUADRATA 220-240V

NEW

CATEGORIA SCONTO 24

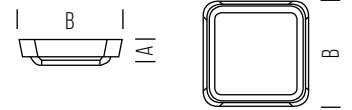

DIMENSIONI	A	B
1	36	180

- Plafoniera quadrata in fusione d'alluminio di facile installazione ideale per applicazioni esterne (es. sottoportici etc...)
- Installazione parete/soffitto



POTENZA WATT	EQUIVALENZA WATT	BASE	KELVIN	LUMEN LM	CANDELE CD	FASCIO °	MISURE MM	CODICE	EAN	IMBALLO	PREZZO € IVA ESCLUSA
10,0	-	-	4000	700	-	110	1	<b>AMBRA10BQ</b>	8031453019518	10	36,30
20,0	-	-	4000	1400	-	110	1	<b>AMBRA20BQ</b>	8031453015688	10	38,80

### AMBRA10BQ

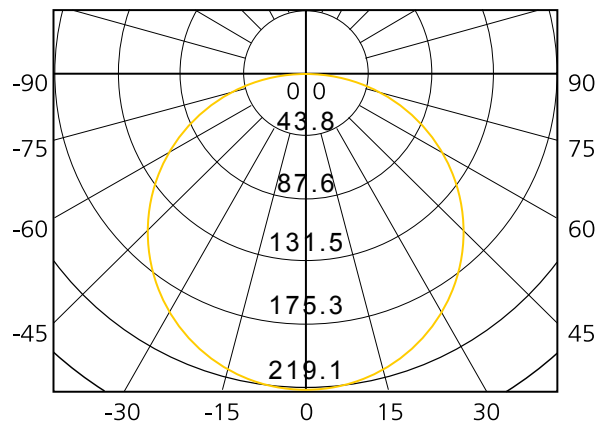
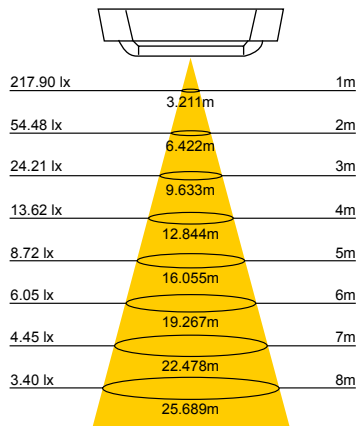

### AMBRA20BQ

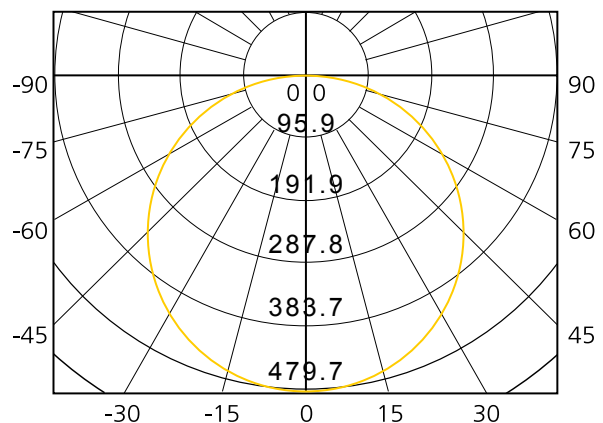
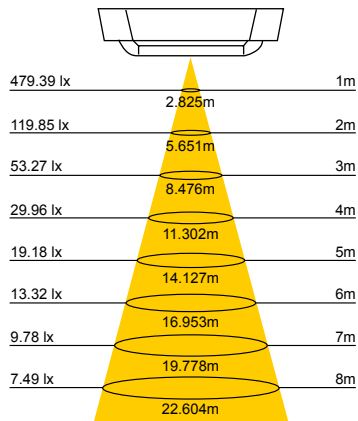

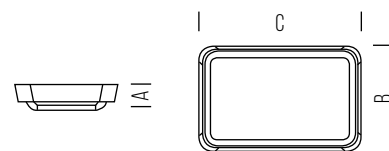

DIMENSIONI	A	B	C
1	36	130	220

- Plafoniera rettangolare in fusione d'alluminio di facile installazione ideale per applicazioni esterne (es. sottoportici etc...)
- Installazione parete/soffitto



POTENZA WATT	EQUIVALENZA WATT	BASE	KELVIN	LUMEN LM	CANDELE CD	FASCIO °	MISURE MM	CODICE	EAN	IMBALLO	PREZZO € IVA ESCLUSA
10,0	-	-	4000	700	-	110	1	<b>AMBRA10BR</b>	8031453015664	10	38,50
20,0	-	-	4000	1400	-	110	1	<b>AMBRA20BR</b>	8031453019525	10	43,00

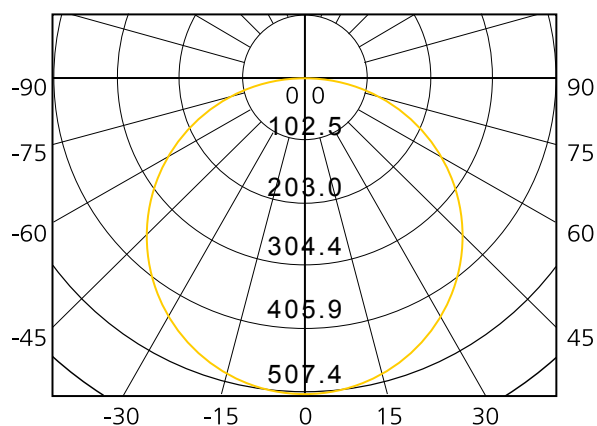
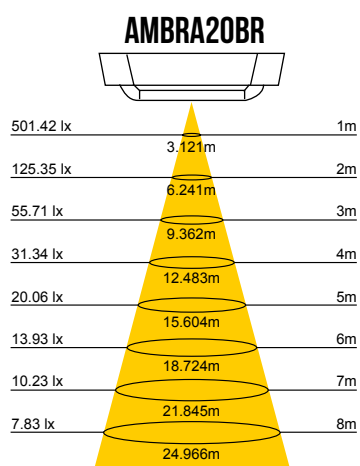
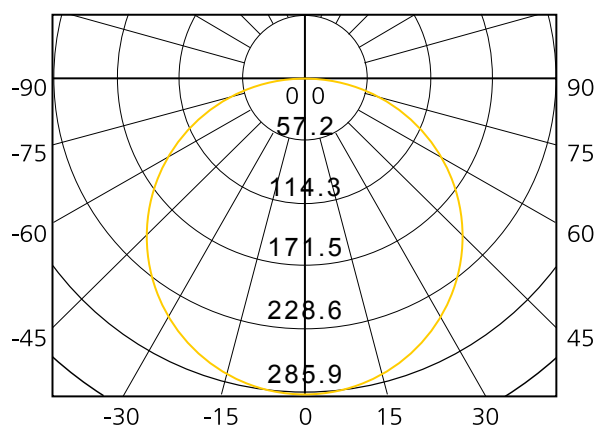
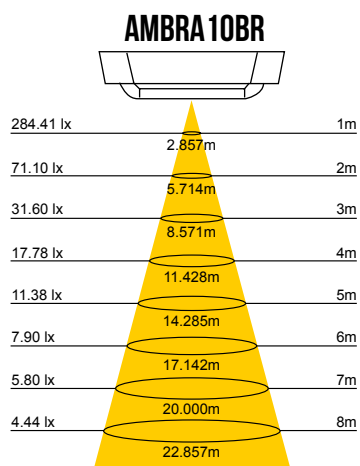

## APPLIQUE NASBY LED DOPPIO FASCIO REGOLABILE 220-240V

NEW

CATEGORIA SCONTO 24

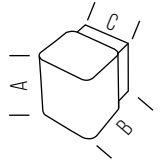

DIMENSIONI	A	B	C
1	138	95	95
2	138	95	95

- Applique da parete in alluminio per interni ed esterni (es. scalinate, corridoi e facciate).
- Doppio fascio LED regolabile da 0° a 80° senza l'uso di attrezzi
- Disponibile in due colori: bianco e antracite - 3000K



POTENZA WATT	EQUIVALENZA WATT	BASE	KELVIN	LUMEN LM	CANDELE CD	FASCIO °	MISURE MM	CODICE	EAN	IMBALLO	PREZZO € IVA ESCLUSA
12	-	-	3000	860	-	-	1	4116459	6435200216304	8	118,00
12	-	-	3000	860	-	-	2	4116460	6435200216328	8	118,00



**APPLIQUE SUND SINGOLO/DOPPIO FASCIO BIANCO**

NEW

CATEGORIA SCONTO 24

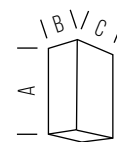

DIMENSIONI	A	B	C
1	68	80	93
2	68	150	93

- Applique da parete in alluminio disponibile in due versioni con fascio singolo o doppio.
- Disponibile in colore bianco.
- Monta due sorgenti LED con attacco GU10 – 11W max (non incluse)



POTENZA WATT	EQUIVALENZA WATT	BASE	KELVIN	LUMEN LM	CANDELE CD	FASCIO °	MISURE MM	CODICE	EAN	IMBALLO	PREZZO € IVA ESCLUSA
-	-	GU10	-	-	-	-	1	<b>4118740</b>	6435200226129	8	26,00
-	-	GU10	-	-	-	-	2	<b>4118742</b>	6435200226167	8	35,20



## APPLIQUE SUND SINGOLO/DOPPIO FASCIO ANTRACITE

NEW

CATEGORIA SCONTO 24

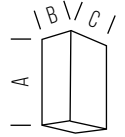

DIMENSIONI	A	B	C
1	68	80	93
2	68	150	93

- Applique da parete in alluminio disponibile in due versioni con fascio singolo o doppio.
- Disponibile in colore antracite.
- Monta due sorgenti LED con attacco GU10 – 11W max (non incluse)



POTENZA WATT	EQUIVALENZA WATT	BASE	KELVIN	LUMEN LM	CANDELE CD	FASCIO °	MISURE MM	CODICE	EAN	IMBALLO	PREZZO € IVA ESCLUSA
-	-	GU10	-	-	-	-	1	4118745	6435200226228	8	26,00
-	-	GU10	-	-	-	-	2	4118746	6435200226242	8	35,20



**APPLIQUE GETA LED QUATTRO FASCI BIANCA**

NEW

CATEGORIA SCONTO 24



DIMENSIONI	A	B	C
1	110	110	50

- Apparecchio da parete che illumina nelle quattro direzioni con possibilità di creare particolari effetti grafici di luci ed ombre.
- Corpo in alluminio di colore bianco
- Adattabile sia per interni che per esterni

INSTANT

NOT DIMMABLE

IP54

MERCURY FREE

25,000 H YEARS

POTENZA WATT	EQUIVALENZA WATT	BASE	KELVIN	LUMEN LM	CANDELE CD	FASCIO °	MISURE MM	CODICE	EAN	IMBALLO	PREZZO € IVA ESCLUSA
8	-	-	3000	160 X 4	-	-	1	4118743	6435200226181	8	83,00



## APPLIQUE GETA LED QUATTRO FASCI ANTRACITE

NEW

CATEGORIA SCONTO 24



DIMENSIONI	A	B	C
1	110	110	50

- Apparecchio da parete che illumina nelle quattro direzioni con possibilità di creare particolari effetti grafici di luci ed ombre.
- Corpo in alluminio di colore antracite
- Adattabile sia per interni che per esterni

INSTANT

NOT DIMMABLE

IP54

MERCURY FREE

25,000 H YEARS

POTENZA WATT	EQUIVALENZA WATT	BASE	KELVIN	LUMEN LM	CANDELE CD	FASCIO °	MISURE MM	CODICE	EAN	IMBALLO	PREZZO € IVA ESCLUSA
8	-	-	3000	160 X 4	-	-	1	4118744	6435200226204	8	83,00



**HOLM SEGNAPASSO**

NEW

CATEGORIA SCONTO 24



1



2

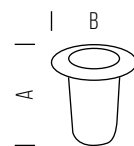

DIMENSIONI	A	B
1	125	118,6
2	139	118,6

- Apparecchio segnapasso calpestabile da terrazza adattabile ad ambienti interni ed esterni
- Utilizzato per illuminazione d'accento
- Disponibile in due versioni con fascio singolo o tre fasci laterali
- Colorazione anello frontale: acciaio inossidabile
- Monta una sorgente led con attacco GU10 - 6W max (non inclusa)



| Ø 100 MM |



POTENZA WATT	EQUIVALENZA WATT	BASE	KELVIN	LUMEN LM	CANDELE CD	FASCIO °	MISURE MM	CODICE	EAN	IMBALLO	PREZZO € IVA ESCLUSA
-	-	GU10	-	-	-	-	1	<b>45 10237</b>	6435200209023	20	46,90
-	-	GU10	-	-	-	-	2	<b>45 10253</b>	6435200217288	20	40,90





**GARDA LAMPADE DA GIARDINO**
**NEW**

CATEGORIA SCONTO 24



DIMENSIONI	A	B
1	530	280
2	1500	350
3	1870	510
4	530	224
5	1450	345

- Apparecchio da tavolo e da terra.
- Utilizzabile in esterno su patii, terrazze o balconi.
- Adatto all'interno, ad esempio in hall e corridoi.
- Corpo realizzato in metallo verniciato a polveri.
- Disponibile in due diversi disegni e diverse altezze.
- Cavo di alimentazione con spina incluso
- Monta una sorgente led con attacco E27 - 40W max (non inclusa)



POTENZA WATT	EQUIVALENZA WATT	BASE	KELVIN	LUMEN LM	CANDELE CD	FASCIO °	MISURE MM	CODICE	EAN	IMBALLO	PREZZO € IVA ESCLUSA
-	-	E27	-	-	-	-	1	<b>4289789</b>	6435200203113	1	102,00
-	-	E27	-	-	-	-	2	<b>4289790</b>	6435200203137	1	160,00
-	-	E27	-	-	-	-	3	<b>4289791</b>	6435200203151	1	380,00
-	-	E27	-	-	-	-	4	<b>4289792</b>	6435200203175	1	104,00
-	-	E27	-	-	-	-	5	<b>4289793</b>	6435200203199	1	155,00





**STONE PIETRA DA GIARDINO**

NEW

CATEGORIA SCONTO 24

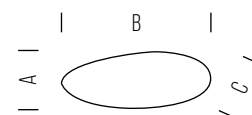

DIMENSIONI	A	B	C
1	180	600	400
2	166	800	496

- Pietra illuminata adatta a creare atmosfera in giardini , terrazze e balconi.
- Disponibile in due formati.
- Monta due sorgenti led attacco E27 - 15W max (non incluse)
- Cavo di alimentazione lungo 3 metri incluso



POTENZA WATT	EQUIVALENZA WATT	BASE	KELVIN	LUMEN LM	CANDELE CD	FASCIO °	MISURE MM	CODICE	EAN	IMBALLO	PREZZO € IVA ESCLUSA
-	-	E27	-	-	-	-	1	4116431	6435200208859	1	136,00
-	-	E27	-	-	-	-	2	4116432	6435200208873	1	195,00





**DENVER 10/20/30/50BW PROIETTORE A LED SLIM BIANCO LUCIDO 200-240V**

**NEW**  
CATEGORIA SCONTO 24

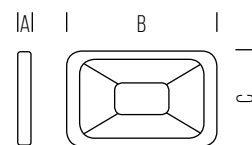

DIMENSIONI	A	B	C
1	20	152	105
2	30	232	155
3	40	300	203

- Proiettore a LED DOB con corpo in alluminio pressofuso ed esclusivo design curvo.
- Colore bianco lucido, CCT 3000K
- Efficienza 70lm/W



POTENZA WATT	EQUIVALENZA WATT	BASE	KELVIN	LUMEN LM	CANDELE CD	FASCIO °	MISURE MM	CODICE	EAN	IMBALLO	PREZZO € IVA ESCLUSA
10,0	-	-	3000	700	650	120	1	<b>DENVER10BW</b>	8031453015794	10	14,00
20,0	-	-	3000	1400	650	120	2	<b>DENVER20BW</b>	8031453015817	4	31,10
30,0	-	-	3000	2100	1000	120	2	<b>DENVER30BW</b>	8031453015831	4	37,20
50,0	-	-	3000	3500	1670	120	3	<b>DENVER50BW</b>	8031453018290	4	54,00

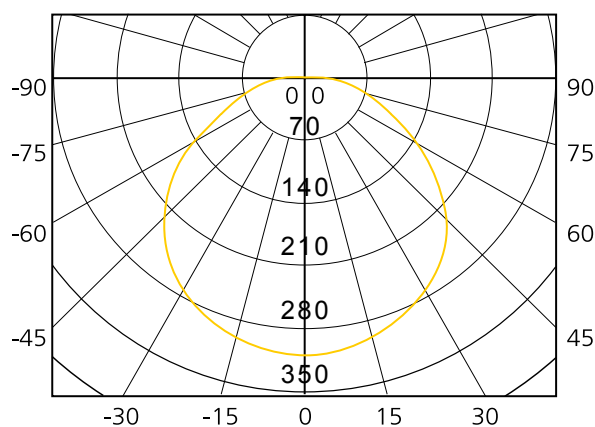
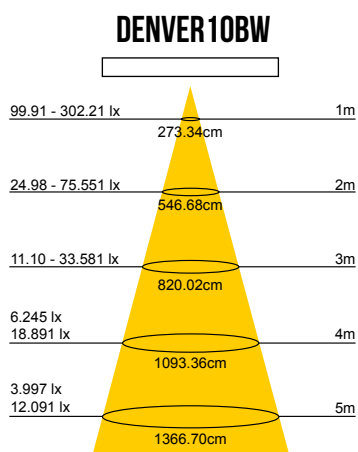

## DENVER20BW

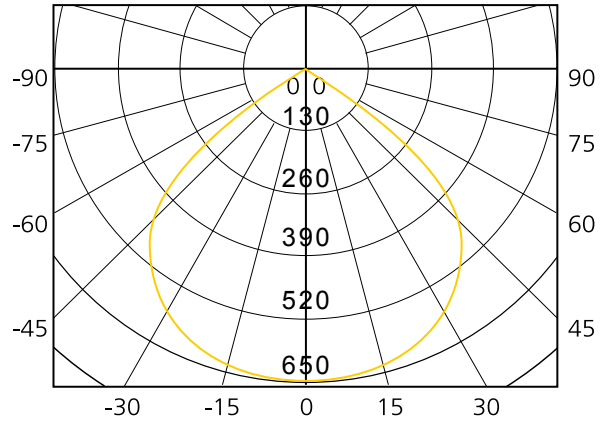
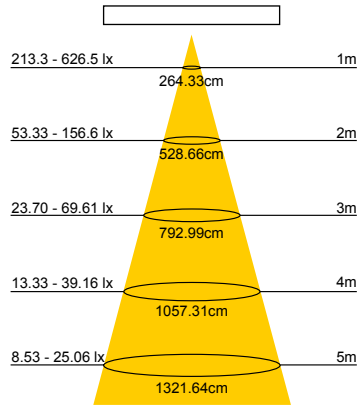

## DENVER30BW

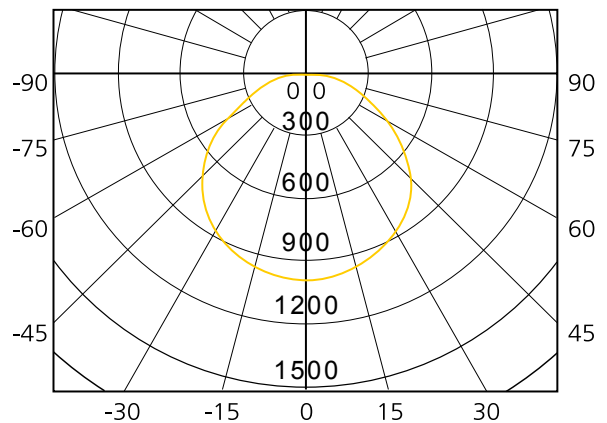
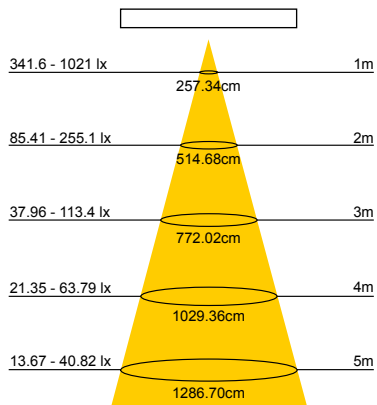

## DENVER50BW

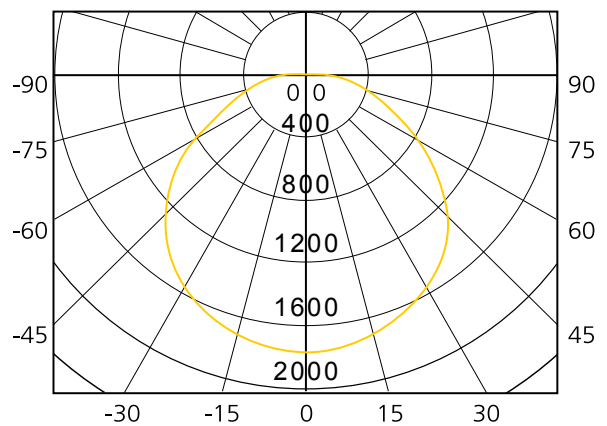
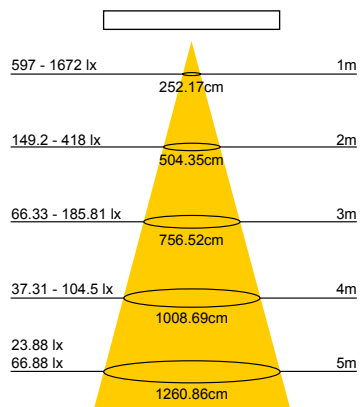

**DENVER 10/20/30/50N PROIETTORE A LED SLIM NERO SATINATO 200-240V**

**NEW**  
CATEGORIA SCONTO 24

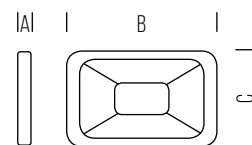

DIMENSIONI	A	B	C
1	20	152	105
2	30	232	155
3	40	300	203

- Proiettore a LED DOB con corpo in alluminio pressofuso ed esclusivo design curvo.
- Colore nero satinato, CCT 4000K/6500K
- Efficienza 77-80lm/W



POTENZA WATT	EQUIVALENZA WATT	BASE	KELVIN	LUMEN LM	CANDELE CD	FASCIO °	MISURE MM	CODICE	EAN	IMBALLO	PREZZO € IVA ESCLUSA
10,0	-	-	4000	770	300	120	1	<b>DENVER10N</b>	8031453015053	10	14,00
10,0	-	-	6500	770	300	120	1	<b>DENVER10ND</b>	8031453018238	10	14,00
20,0	-	-	4000	1600	650	120	2	<b>DENVER20N</b>	8031453015077	4	31,10
20,0	-	-	6500	1600	650	120	2	<b>DENVER20ND</b>	8031453018252	4	31,10
30,0	-	-	4000	2400	1000	120	2	<b>DENVER30N</b>	8031453015770	4	37,20
30,0	-	-	6500	2400	1000	120	2	<b>DENVER30ND</b>	8031453018276	4	37,20
50,0	-	-	4000	3900	1670	120	3	<b>DENVER50N</b>	8031453018313	4	54,00
50,0	-	-	6500	3900	1670	120	3	<b>DENVER50ND</b>	8031453018337	4	54,00

**DENVER10N - DENVER10ND**

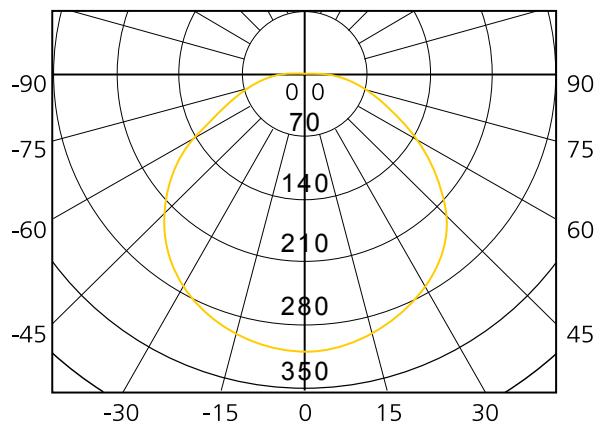
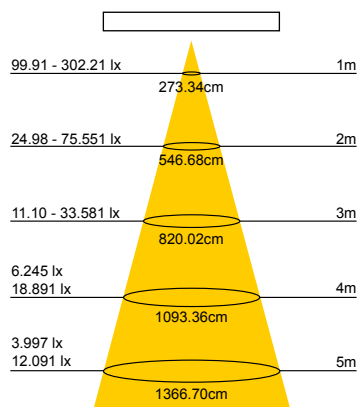



## DENVER20N - DENVER20ND

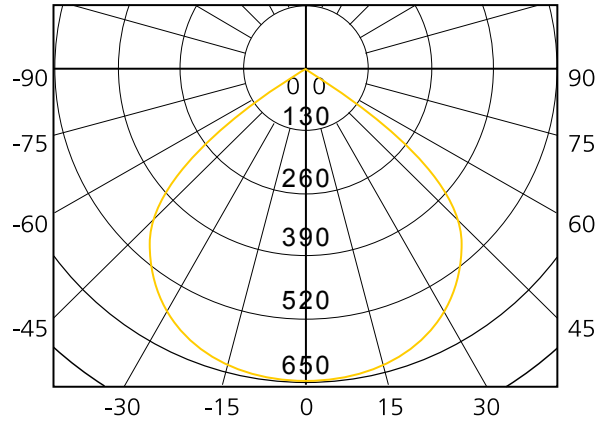
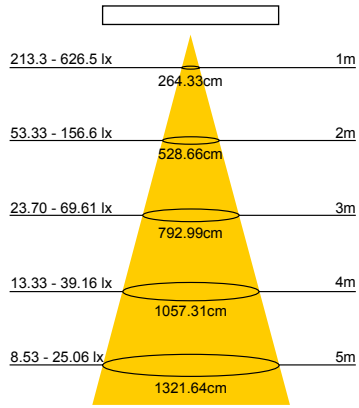

## DENVER30N - DENVER30ND

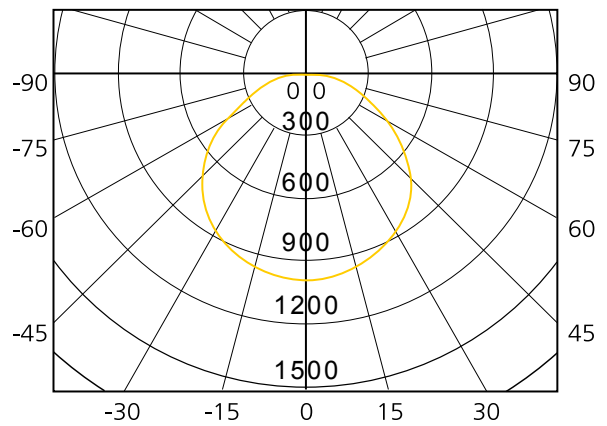
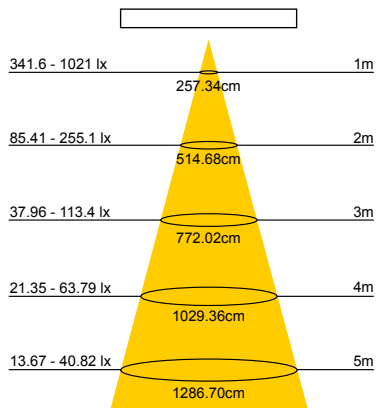

## DENVER50N - DENVER50ND

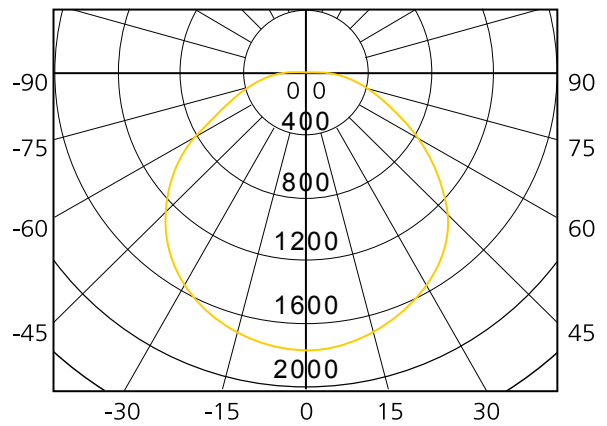
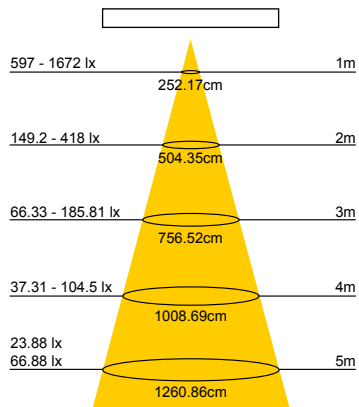

**DENVER 20/30N PROIETTORE A LED SLIM NERO SATINATO CON SENSORE DI MOVIMENTO PIR 200-240V**

**NEW**  
CATEGORIA SCONTO 24

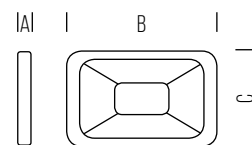

DIMENSIONI	A	B	C
1	55	232	218

- Proiettore a LED DOB con corpo in alluminio pressofuso ed esclusivo design curvo.
- Sensore di movimento infrarosso PIR regolabile:
  - Luce ambiente: 2-2000 lux
  - Distanza di rilevamento: 2-12m
  - Tempo di accensione 5sec - 10m
- Altezza di installazione: 2-3m
- Colore nero satinato, CCT 4000K
- Efficienza 80lm/W

NOT DIMMABLE  
 PIR  
 INSTANT  
 MERCURY-FREE  
 IP44  
 m  
 20,000 H YEARS

POTENZA WATT	EQUIVALENZA WATT	BASE	KELVIN	LUMEN LM	CANDELE CD	FASCIO °	MISURE MM	CODICE	EAN	IMBALLO	PREZZO € IVA ESCLUSA
20,0	-	-	4000	1600	650	120	1	DENVER20NIR	8031453018351	4	45,00
30,0	-	-	4000	2400	1000	120	1	DENVER30NIR	8031453018375	4	51,00

**DENVER20NIR**

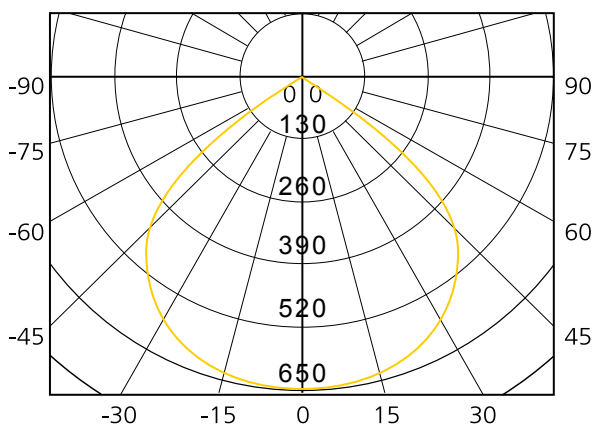
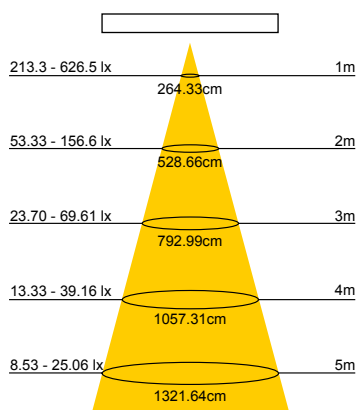

**DENVER30NIR**

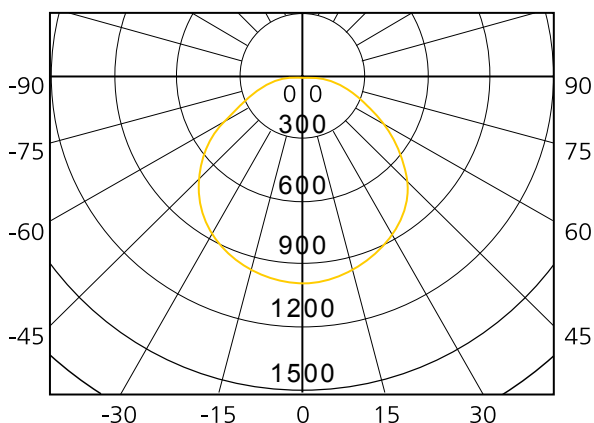
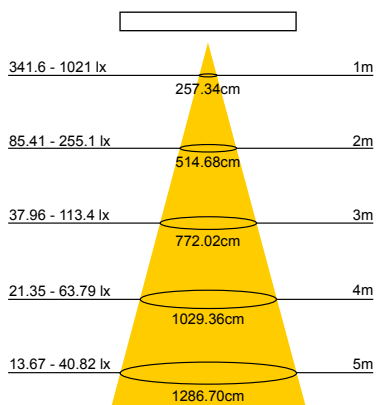



**MIAMI 10/20/30BW PROIETTORE A LED SLIM BIANCO 100-240V**

CATEGORIA SCONTO 24

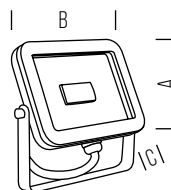

DIMENSIONI	A	B	C
1	94,6	129	23
2	135	185	26,8
3	170	265	38

- Proiettore a LED ultrapiatto con corpo in alluminio pressofuso.
- Colore bianco lucido con cornice argento, CCT 3000K
- Efficienza 75lm/W



POTENZA WATT	KELVIN	LUMEN LM	FASCIO °	MISURE MM	CODICE	EAN	IMBALLO	PREZZO € IVA ESCLUSA
10	3000	750	100	1	MIAMI10BW	8031453012441	10	28,60
20	3000	1500	100	2	MIAMI20BW	8031453012489	10	48,00
30	3000	2200	100	3	MIAMI30BW	8031453013837	4	76,00

**MIAMI 10/20/30N PROIETTORE A LED SLIM NERO LUCIDO 100-240V**

CATEGORIA SCONTO 24

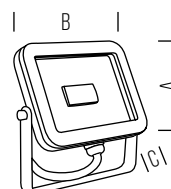

DIMENSIONI	A	B	C
1	94,6	129	23
2	135	185	26,8
3	170	265	38

- Proiettore a LED ultrapiatto con corpo in alluminio pressofuso.
- Colore nero lucido con cornice argento, CCT 4000K
- Efficienza 75lm/W



POTENZA WATT	KELVIN	LUMEN LM	FASCIO °	MISURE MM	CODICE	EAN	IMBALLO	PREZZO € IVA ESCLUSA
10	4000	750	100	1	MIAMI10N	8031453012427	10	28,60
20	4000	1500	100	2	MIAMI20N	8031453012465	10	48,00
30	4000	2200	100	3	MIAMI30N	8031453013851	4	76,00

## MIAMI10BW - N

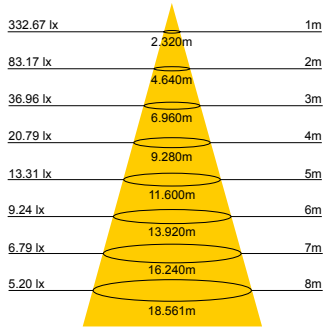

## MIAMI20BW - N

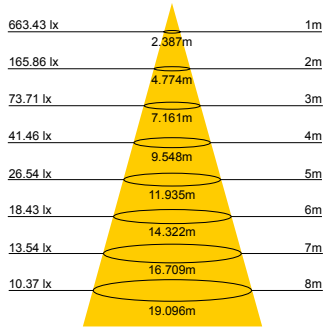

## MIAMI30BW - N

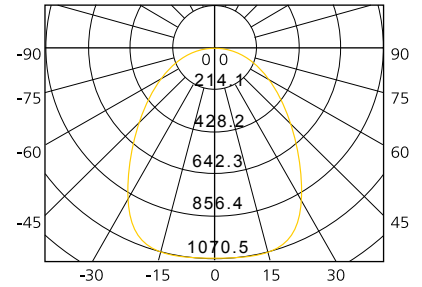
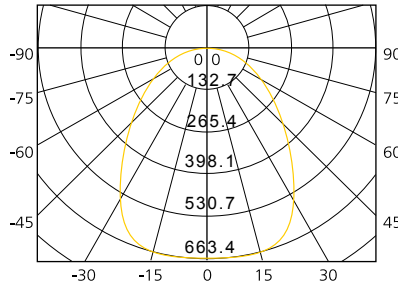
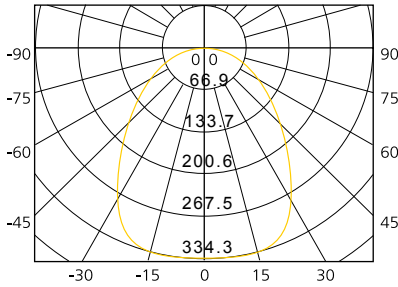
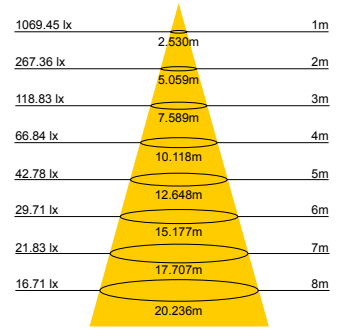

## MIAMI 20N MW PROIETTORE A LED SLIM NERO LUCIDO CON SENSORE DI MOVIMENTO MICROONDE 100-240V

CATEGORIA SCONTO 24

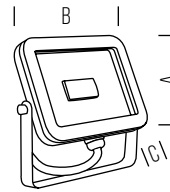

DIMENSIONI	A	B	C
1	200	213	28.5

- Proiettore a LED ultrapiatto con corpo in alluminio pressofuso.
- Colore nero lucido con cornice argento, CCT 4000K
- Sensore di movimento a microonde regolabile:
  - Luce ambiente: <math>< 5\text{lx}</math> ~ 1000lx
  - Distanza di rilevamento: 2 ~ 12m
  - Tempo di accensione: 5Sec. ~ 8Min.
- Altezza di installazione: 1.8 ~ 2.5m.
- Efficienza 75lm/W
- Protezione: IP65 - Sensore: IP44

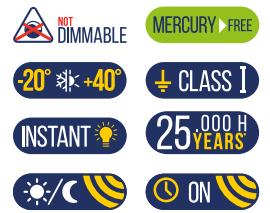

POTENZA WATT	KELVIN	LUMEN LM	FASCIO °	MISURE MM	CODICE	EAN	IMBALLO	PREZZO € IVA ESCLUSA
20	4000	1500	100	1	MIAMI20NMW	8031453013875	10	78,00

## MIAMI20NMW

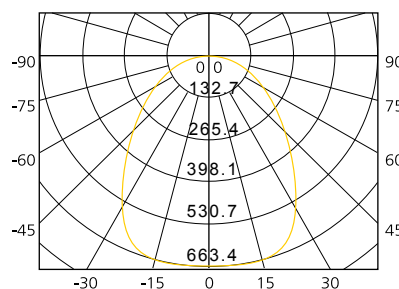
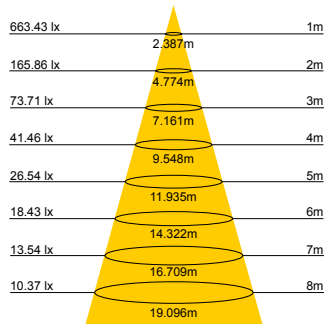

**DALLAS SMALL 30/50BW PROIETTORE A LED BIANCO PROFESSIONAL 220-240V**

NEW

CATEGORIA SCONTO 24

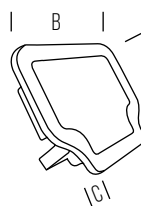

DIMENSIONI	A	B	C
1	65	151	165
2	78	190	220

- Proiettore a LED con corpo in materiale plastico, diffusore in alluminio e vetro temperato diffondente.
- Colore bianco (diffusore color alluminio), CCT 3000K
- Alta efficienza 100lm/W



POTENZA WATT	KELVIN	LUMEN LM	FASCIO °	MISURE MM	CODICE	EAN	IMBALLO	PREZZO € IVA ESCLUSA
30,0	3000	3000	100	1	<b>DALLAS30BW</b>	8031453018733	4	33,00
50,0	3000	5000	100	2	<b>DALLAS50BW</b>	8031453018672	4	48,00

**DALLAS30BW**

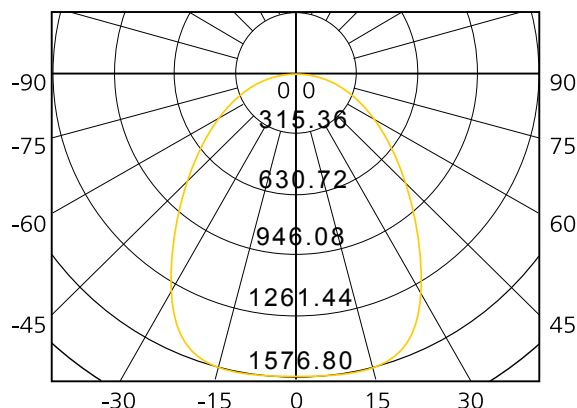
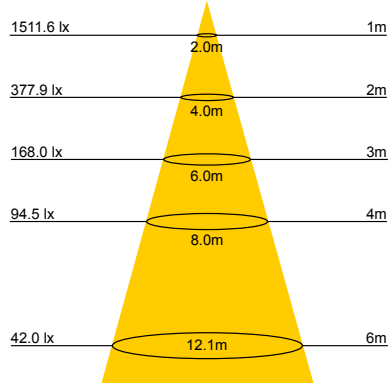

**DALLAS50BW**

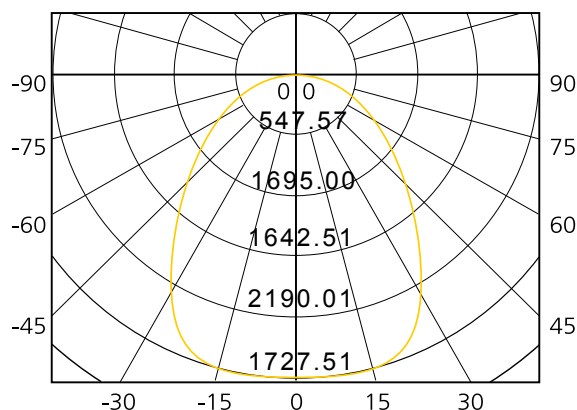
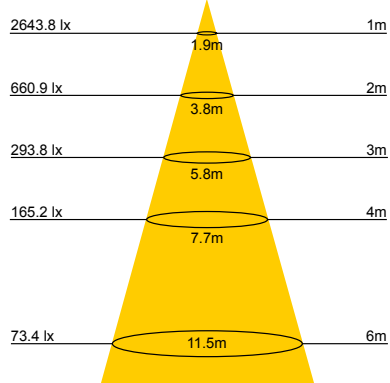

## DALLAS SMALL 30/50N PROIETTORE A LED NERO PROFESSIONAL 220-240V

NEW

CATEGORIA SCONTO 24

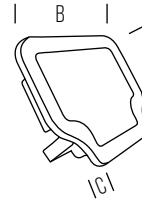

DIMENSIONI	A	B	C
1	65	151	165
2	78	190	220

- Proiettore a LED con corpo in materiale plastico, diffusore in alluminio e vetro temperato diffondente.
- Colore nero (diffusore alluminio nero), CCT 4000K
- Alta efficienza 100lm/W



POTENZA WATT	KELVIN	LUMEN LM	FASCIO °	MISURE MM	CODICE	EAN	IMBALLO	PREZZO € IVA ESCLUSA
30,0	4000	3000	100	1	<b>DALLAS30N</b>	8031453018719	4	33,00
50,0	4000	5000	100	2	<b>DALLAS50N</b>	8031453018696	4	48,00

### DALLAS30N

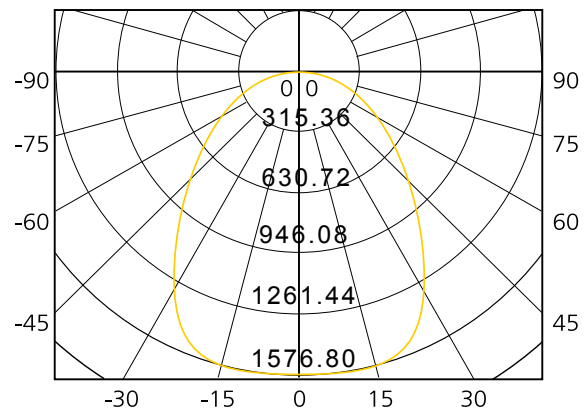
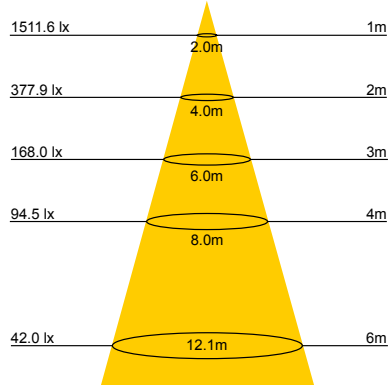

### DALLAS50N

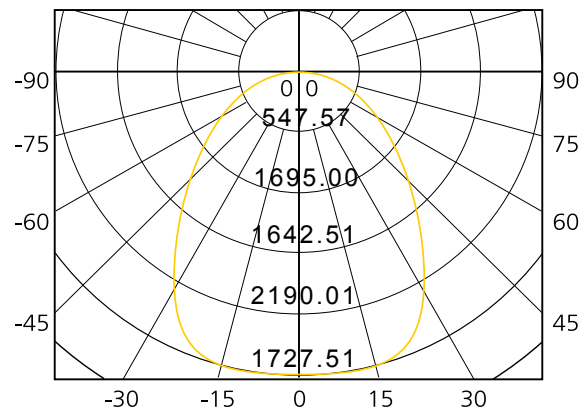
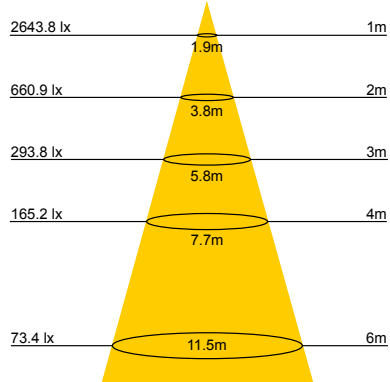

## DALLAS BIG 100/150/200N PROIETTORE A LED NERO PROFESSIONAL 220-240V

NEW

CATEGORIA SCONTO 24

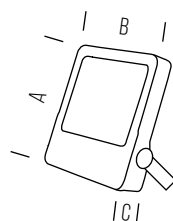

DIMENSIONI	A	B	C
1	231	280	70
2	275	335	85
3	370	440	103

- Proiettore a LED professionale con corpo compatto in alluminio pressofuso
- Colore nero, CCT 4000K
- Alta efficienza 100lm/W



POTENZA WATT	KELVIN	LUMEN LM	FASCIO °	MISURE MM	CODICE	EAN	IMBALLO	PREZZO € IVA ESCLUSA
100	4000	10500	110	1	<b>DALLAS100N</b>	8031453019532	4	138,00
150	4000	15750	110	2	<b>DALLAS150N</b>	8031453019549	4	195,00
200	4000	21000	110	3	<b>DALLAS200N</b>	8031453019556	4	279,00

### DALLAS100N

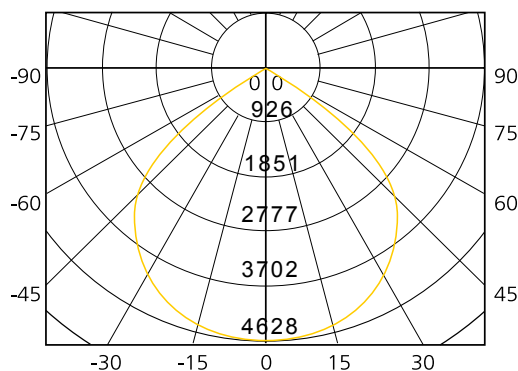
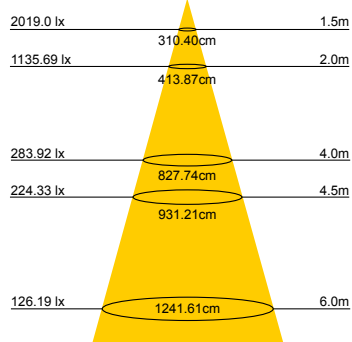

### DALLAS150N

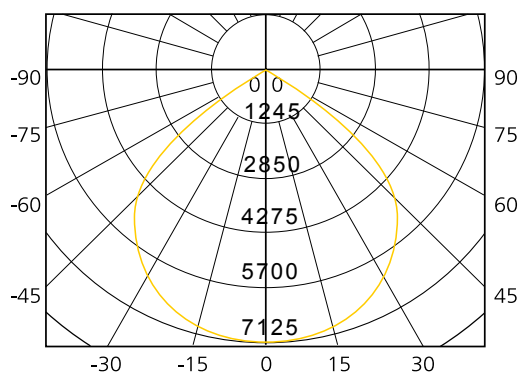
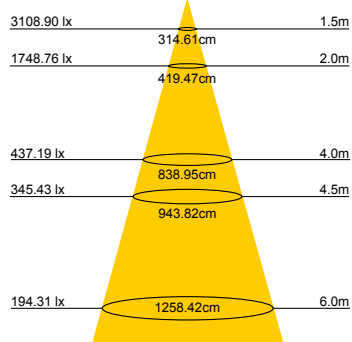

### DALLAS200N

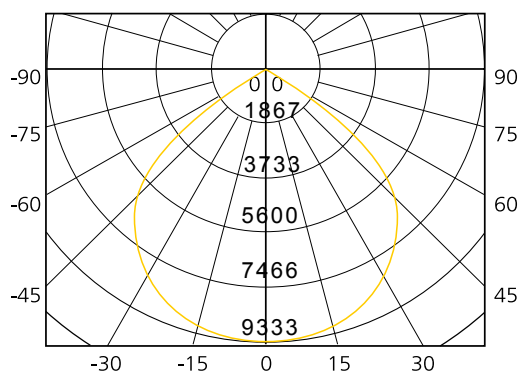
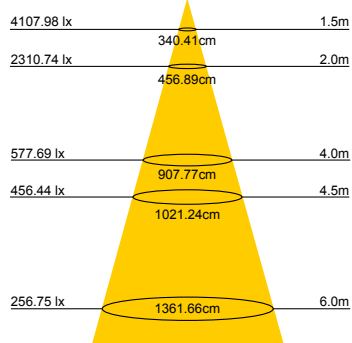





**NEW YORK 40/80G PROIETTORE A LED ANTRACITE PROFESSIONAL 100-240V**

CATEGORIA SCONTO 24

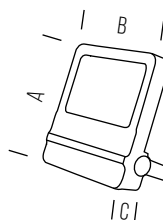

DIMENSIONI	A	B	C
1	228	217	85
2	357	262	90

- Proiettore a LED professionale con corpo compatto in alluminio pressofuso e diffusore in alluminio anodizzato.
- Nuova gamma: potenza ridotta del 20% grazie all'uso di chip di nuova generazione. Temperatura di esercizio più bassa e quindi maggiore affidabilità.
- Colore grigio antracite, CCT 4000K
- Alta efficienza 105-110lm/W



POTENZA WATT	KELVIN	LUMEN LM	FASCIO °	MISURE MM	CODICE	EAN	IMBALLO	PREZZO € IVA ESCLUSA
40	4000	4200	120	1	<b>NY4200GS</b>	8031453015732	2	136,00
80	4000	9000	120	2	<b>NY9000GS</b>	8031453015756	2	231,00

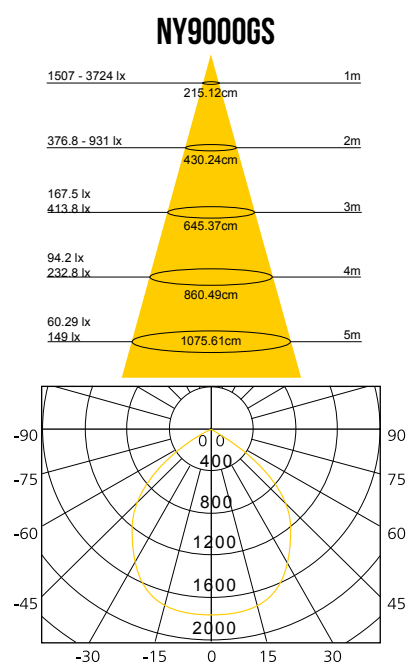
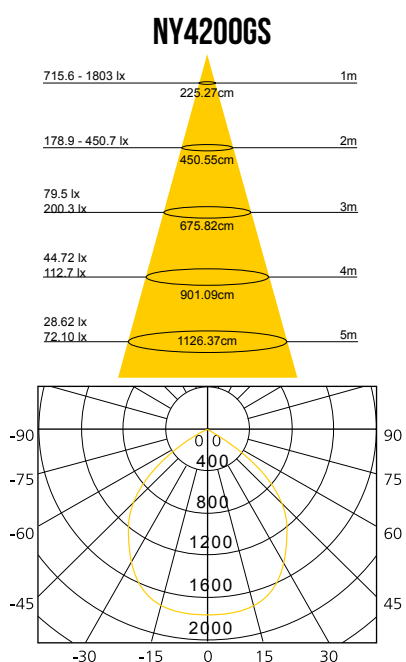

## TOKYO 150/200N PROIETTORE A LED NERO PROFESSIONAL 100-240V

CATEGORIA SCONTO 24

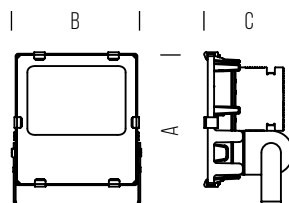

DIMENSIONI	A	B	C
1	325	300	195
2	390	340	200

- Proiettore a LED professionale con corpo in alluminio pressofuso, diffusore con alettatura oversized per utilizzo intenso.
- Vetro frontale temperato trasparente. Driver separato montato posteriormente.
- Colore nero, CCT 4000K
- Efficienza 85lm/W



POTENZA WATT	KELVIN	LUMEN LM	FASCIO °	MISURE MM	CODICE	EAN	IMBALLO	PREZZO € IVA ESCLUSA
150	4000	13000	100	1	TOKYO150N	8031453015299	1	500,00
200	4000	17000	100	2	TOKYO200N	8031453015305	1	650,00

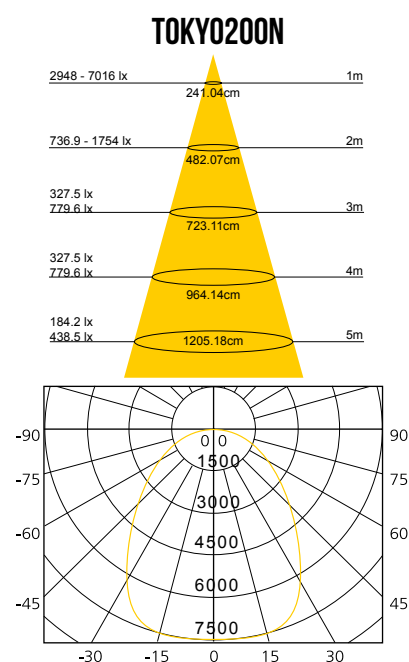
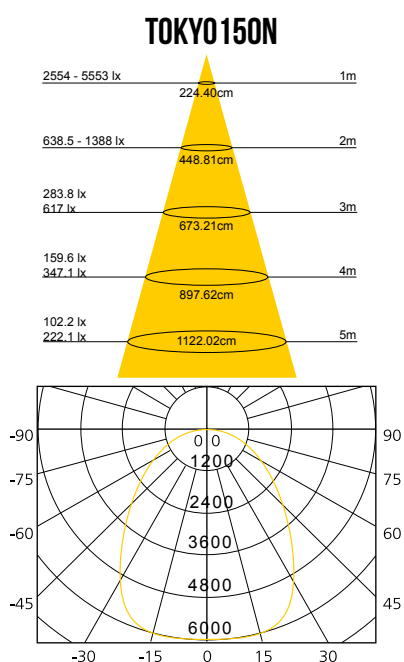

## AKRON 20N 12/24V AC/DC

NEW

CATEGORIA SCONTO 24

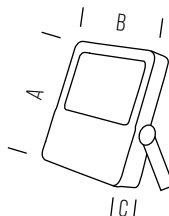

DIMENSIONI	A	B	C
1	185	155	50

- Proiettore 12-24V AC/DC LED COB ideale per imbarcazioni, camper e per tutte le applicazioni a bassissima tensione.
- Corpo in alluminio pressofuso e vetro frontale temperato
- Colore grigio antracite, CCT 4000K



POTENZA WATT	KELVIN	LUMEN LM	FASCIO °	MISURE MM	CODICE	EAN	IMBALLO	PREZZO € IVA ESCLUSA
20	4000	1600	120	1	AKRON20NLV	8031453019648	6	39,00

## STAND PER PROIETTORE

CATEGORIA SCONTO 24



- Stand in alluminio adattabile a diversi modelli di proiettore completo di cavo di alimentazione.
- Altezza minima 70cm, altezza massima 165cm
- Peso massimo consentito: 2.5kg

IP44

IP	ALTEZZA	PESO	CODICE	EAN	IMBALLO	PREZZO € IVA ESCLUSA
44	MIN. 70CM - MAX. 165CM	MAX 2,5KG	STAND	8031453012595	6	36,00

### AKRON20NLV

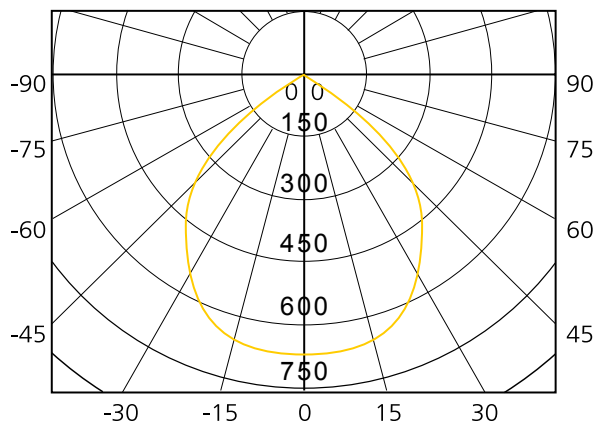
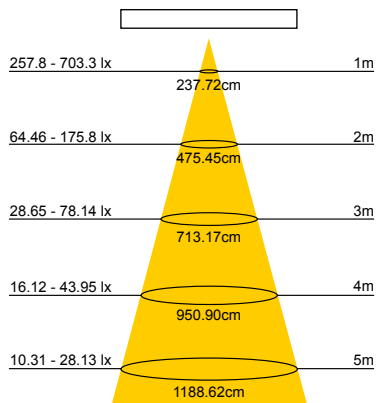



## PLAFONIERA STAGNA LED 220-240V

AGGIORNATO

CATEGORIA SCONTO 24

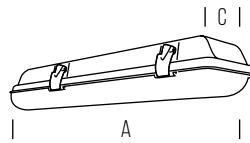

DIMENSIONI	A	B	C
1	658	118	74
2	1268	118	74
3	1568	118	74



- Plafoniera stagna con schermo diffondente in policarbonato e ganci in acciaio.
- Piastra a LED integrata di nuova generazione con prestazioni migliorate, offre ottimi risultati in termini di luminosità.
- Lunga durata grazie ai suoi materiali resistenti all'acqua, polvere e corrosione.
- Corpo in colore grigio, CCT 4000K
- Alta efficienza fino a 115 lm/W
- Eventuale schermo di ricambio da ordinare a parte

POTENZA WATT	BASE	KELVIN	LUMEN LM	LUMEN UTILI	CANDELE CD	FASCIO °	MISURE MM	CODICE	EAN	IMBALLO	PREZZO € IVA ESCLUSA
18,5	-	4000	2100	-	-	180	1	LD1WPF203	8031453017460	5	47,50
40,5	-	4000	4600	-	-	180	2	LD1WPF403	8031453017484	5	73,00
58	-	4000	6700	-	-	180	3	LD1WPF583	8031453017507	5	85,60

IP65

## SCHERMO RICAMBIO PLAFONIERA STAGNA LED

CATEGORIA SCONTO 24



DIMENSIONI	LUNGHEZZA
1	658
2	1268
3	1568

MISURE MM	CODICE	EAN	IMBALLO	PREZZO € IVA ESCLUSA
1	LD1WPFSC600	8031453011154	10	8,40
2	LD1WPFSC1200	8031453011178	10	14,70
3	LD1WPFSC1500	8031453011192	10	19,60

### LD1WPF203

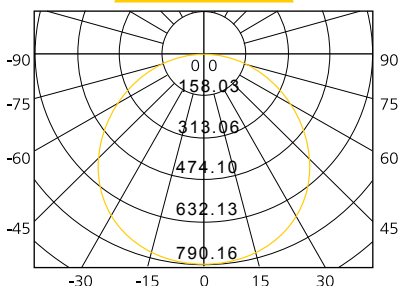
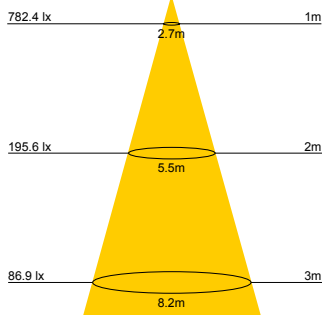
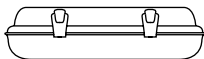

### LD1WPF403

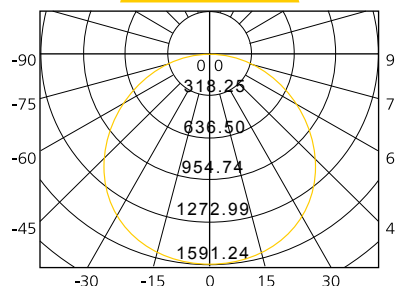
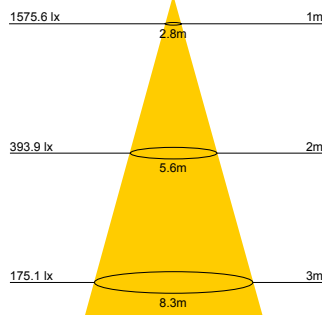
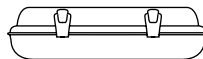

### LD1WPF583

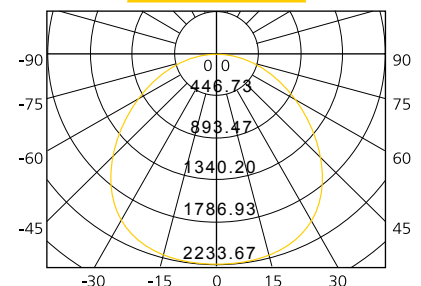
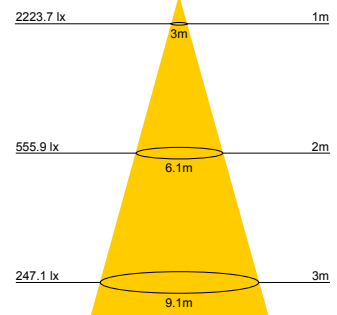
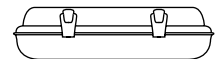

## HIGH BAY A LED 220-240V

AGGIORNATO

CATEGORIA SCONTO 24

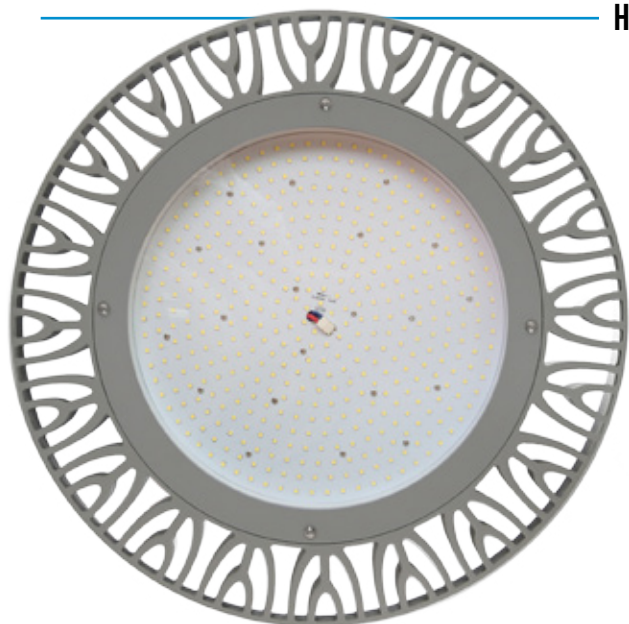

- Proiettore per illuminazione industriale ideale per la sostituzione degli apparecchi tradizionali a scarica da 250W e 400W in ambienti come magazzini, capannoni, grandi superfici.
- Corpo in pressofusione in alluminio ADC12 verniciata a polveri epossidiche in colore Grigio Agata RAL7038
- Vetro temperato spessore 4mm
- LED SMD 3030 ad alta efficienza (125lm/W) e CRI>80

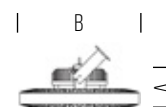

DIMENSIONI	A	B
1	139	420
2	149	420

- Dimmer integrato 3 in uno (resistore, 1-10V, segnale PWM)
- Anello per montaggio a sospensione incluso
- Durata: 50.000h
- Corpo IP65, di serie connettori IP65 per cavo di alimentazione e cavo dimmer
- Accessori opzionali: riflettori per fascio 60° o 90° colore esterno nero, staffa orientabile per montaggio a parete/soffitto

MERCURY FREE

DIMMABLE

CLASS I

IP65

INSTANT

50.000 H YEARS

POTENZA WATT	LUMEN LM	KELVIN	FASCIO °	MISURE MM	CODICE	EAN	IMBALLO	PREZZO € IVA ESCLUSA
100	12000	4000	120	1	LD1HB100G	8031453015312	1	430,00
150	18000	4000	120	2	LD1HB150G	8031453018399	1	494,00
220	26400	4000	120	2	LD1HB220G	8031453015329	1	582,00

NEW

## STAFFA OPZIONALE PER HIGH BAY

NEW

CATEGORIA SCONTO 24



MISURE MM	FASCIO °	CODICE	EAN	IMBALLO	PREZZO € IVA ESCLUSA
-	-	LD1HBKIT	8031453018467	10	15,50

## DIFFUSORE OPZIONALE PER HIGH BAY 60°/90°

CATEGORIA SCONTO 24



DIMENSIONI	A	B
1	172	408
2	250	527

MISURE MM	FASCIO °	CODICE	EAN	IMBALLO	PREZZO € IVA ESCLUSA
1	60	LD1HBREF60N	8031453015336	10	36,00
2	90	LD1HBREF90N	8031453015343	10	36,00

### LD1HB100G - 60°

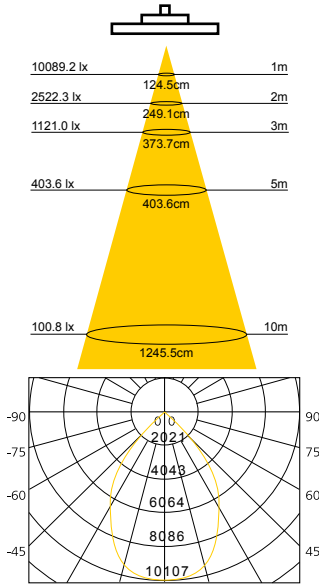

### LD1HB150G - 60°

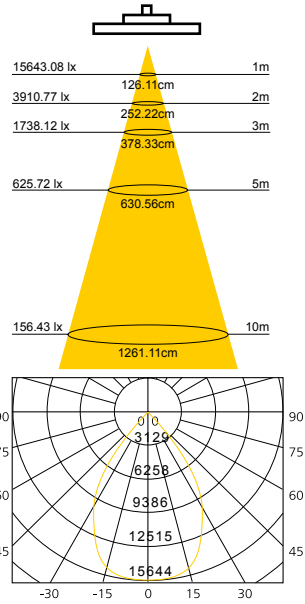

### LD1HB220G - 60°

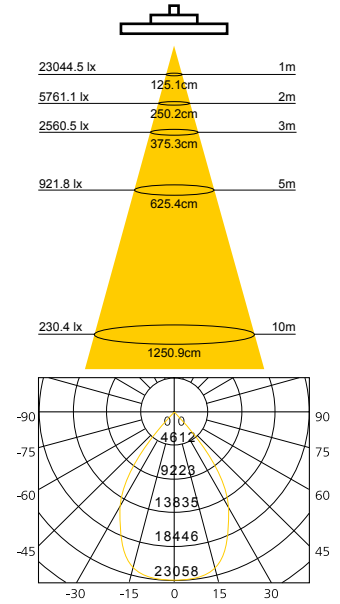

### LD1HB100G - 90°

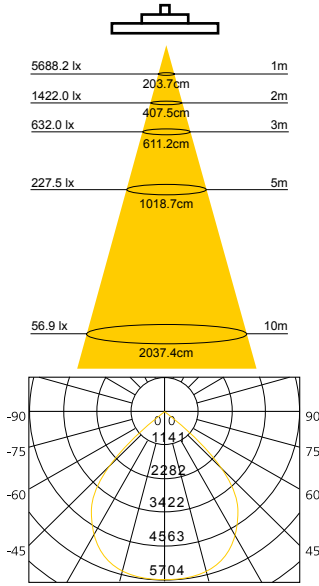

### LD1HB150G - 90°

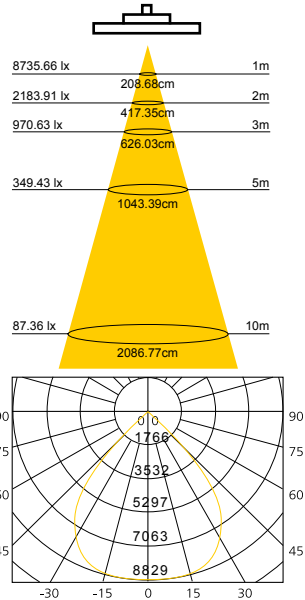

### LD1HB220G - 90°

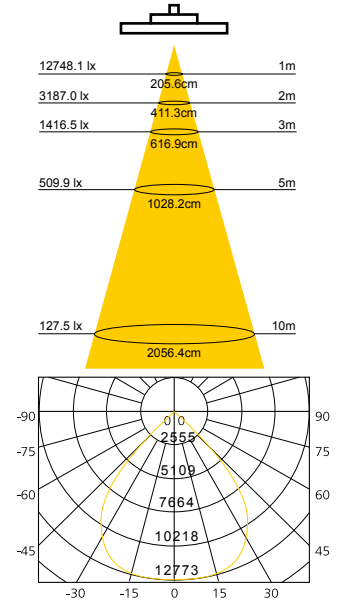

### LD1HB100G - 120°

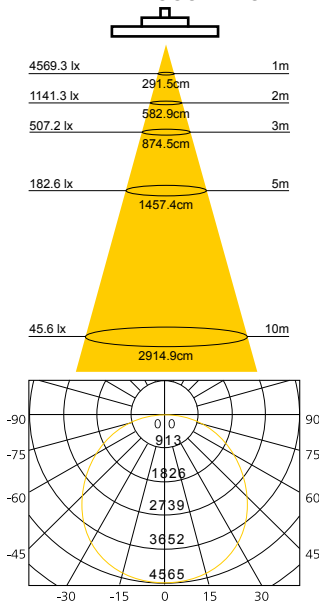

### LD1HB150G - 120°

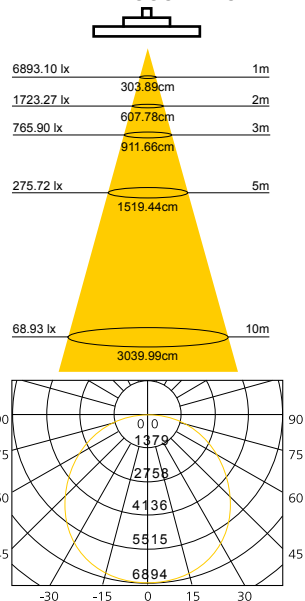

### LD1HB220G - 120°

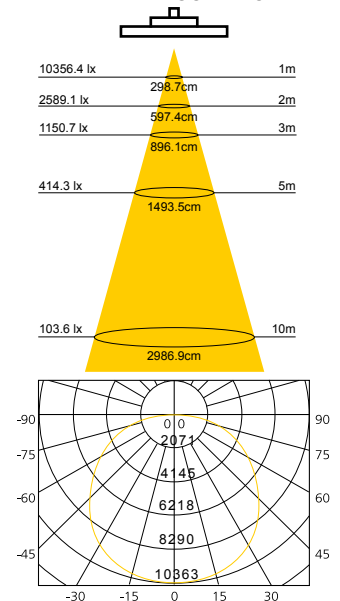







APPARECCHI A LED  
LUCE NOTTURNA E PORTATILI

**LUCE NOTTURNA POWER LED 230V**

CATEGORIA SCONTO 16

- Luce notturna da presa a basso consumo energetico e lunga durata
- Interruttore ON/OFF
- Temperatura di colore: 2900K
- 1W – 14lm non intercambiabile



CODICE	EAN	IMBALLO	PREZZO € IVA ESCLUSA
LED20	6435200173836	5	6,50

**LUCE NOTTURNA POWER LED CREPUSCOLARE 230V**

CATEGORIA SCONTO 16

- Luce notturna da presa a basso consumo energetico e lunga durata
- Interruttore automatico crepuscolare, si accende la sera e si spegne al mattino
- Temperatura di colore: 2900K
- 1W – 14lm non intercambiabile



CODICE	EAN	IMBALLO	PREZZO € IVA ESCLUSA
LED21	6435200173843	5	6,90

**LUCE NOTTURNA POWER LED CREPUSCOLARE CON SENSORE DI MOVIMENTO 230V**

CATEGORIA SCONTO 16

- Luce notturna da presa a basso consumo energetico e lunga durata
- Interruttore automatico crepuscolare, si accende la sera e si spegne al mattino
- Sensore di movimento, si accende solo quando rileva il passaggio
- Temperatura di colore: 6000K
- 1,8W – 15lm non intercambiabile



CODICE	EAN	IMBALLO	PREZZO € IVA ESCLUSA
LED23	6435200174949	6	20,45



## LUCE NOTTURNA POWER LED CREPUSCOLARE 230V

CATEGORIA SCONTO 16

- Luce notturna da presa a basso consumo energetico e lunga durata
- Interruttore automatico crepuscolare, si accende la sera e si spegne al mattino
- Temperatura di colore: 6000K
- 0,4W - 1,5lm non intercambiabile



CODICE	EAN	IMBALLO	PREZZO € IVA ESCLUSA
LED24	6435200174956	6	6,80



## LUCE NOTTURNA NEVADA POWER LED CREPUSCOLARE 230V

NEW

CATEGORIA SCONTO 16

- Luce notturna da presa
- Interruttore automatico crepuscolare, si accende la sera e si spegne al mattino
- Sensore di movimento
- Temperatura di colore: 2900K
- 1W - 14lm non intercambiabile



CODICE	EAN	IMBALLO	PREZZO € IVA ESCLUSA
4116494	6435200216267	5	7,15



## LUCE NOTTURNA DOVER POWER LED CON PRESE USB 230V

NEW

CATEGORIA SCONTO 16

- Luce notturna da presa
- Interruttore automatico crepuscolare
- Sensore di movimento
- Due prese USB 2,1 A - 5V
- Temperatura di colore: 3000K
- 0,4W - 9lm non intercambiabile



CODICE	EAN	IMBALLO	PREZZO € IVA ESCLUSA
4116495	6435200216281	6	23,70

**LAMPADA DA ARMADIO CABINET CON SENSORE DI MOVIMENTO**

NEW

CATEGORIA SCONTO 16



- Lampada da armadio in policarbonato ABS con sensore di movimento PIR
- Interruttore ON/OFF
- Dimensioni: larghezza 300mm, lunghezza 45mm
- Temperatura di colore 3000K - 400lm
- 1,2W - 80lm - 6 LED non intercambiabile
- Batterie: 4 x AA 1,5V (non incluse)

CODICE

EAN

IMBALLO

 PREZZO €  
 IVA ESCLUSA

8710464

6435200213563

5

18,40

**LED BYCICLE FRONT LIGHT**

NEW

CATEGORIA SCONTO 16

- Lampada frontale per bici
- Montaggio a sgancio rapido universale
- Interruttore ON/OFF
- Tre livelli di luminosità: 100%,30%, lampeggiante
- Modalità 6 LED (safety light) premendo il pulsante ON per 3 secondi
- 3W - 150lm
- Batterie: AAA (non incluse)

CODICE

EAN

IMBALLO

 PREZZO €  
 IVA ESCLUSA

8710462

6435200213525

6

6,95

**LED BYCICLE FRONT LIGHT POWER LED**

NEW

CATEGORIA SCONTO 16

- Lampada frontale per bici
- Montaggio a sgancio rapido universale
- Interruttore ON/OFF con due modalità di funzionamento
- 5W - 250lm
- Batterie: 3XAAA (non incluse)

CODICE

EAN

IMBALLO

 PREZZO €  
 IVA ESCLUSA

8710484

6435200218872

6

14,50

NEW

CATEGORIA SCONTO 16

## LED BYCICLE FRONT LIGHT CON CARICA USB



- Lampada frontale per bici con ricarica USB
- Interruttore ON/OFF con due modalità di funzionamento
- 3W - 300lm

BLISTER

CODICE	EAN	IMBALLO	PREZZO € IVA ESCLUSA
8710487	6435200218902	6	26,50

NEW

CATEGORIA SCONTO 16

## LED BYCICLE FRONT LIGHT SMALL



- Airam safety light colore bianco multiuso per biciclette, carrozzine, caschi, scooter
- Interruttore ON/OFF con due modalità di funzionamento: fissa ed intermittente
- Batterie: 2XCR2032 (incluse)

BLISTER

CODICE	EAN	IMBALLO	PREZZO € IVA ESCLUSA
8710495	6435200225931	6	6,90

NEW

CATEGORIA SCONTO 16

## LED BYCICLE BACK LIGHT SMALL



- Airam safety light colore rosso multiuso per biciclette, carrozzine, caschi, scooter
- Interruttore ON/OFF con due modalità di funzionamento: fissa ed intermittente
- Batterie: 2XCR2032 (incluse)

BLISTER

CODICE	EAN	IMBALLO	PREZZO € IVA ESCLUSA
8710457	6435200213327	6	6,90

**LED BYCICLE REAR RED LIGHT**

NEW

CATEGORIA SCONTO 16

- Lampada posteriore per bici. Montaggio a sgancio rapido universale
- Interruttore ON/OFF con due modalità di funzionamento: fissa ed intermittente
- 5 LED
- Batterie: 2xAAA (non incluse)



CODICE	EAN	IMBALLO	PREZZO € IVA ESCLUSA
8710465	6435200213587	6	3,05

**LED DUO MULTI POWER-LED**

CATEGORIA SCONTO 16

- Airam POWER-LED, led multiuso per biciclette, caschi, scooter o carrozzine
- Vita dei LED fino a 10.000h.
- Pulsante ON/OFF con 2 modalità di funzionamento: fissa ed intermittente.
- Fascia elastica facile da inserire e togliere per utilizzo portatile
- Resistente all'acqua
- Batterie: 2XCR2032 (non incluse)
- 3 LED
- Autonomia di 100/150h



CODICE	EAN	IMBALLO	PREZZO € IVA ESCLUSA
LED12B	6435200139399	6	16,50



## FASCIA RUNNING RED

NEW

CATEGORIA SCONTO 16

- Fascia luminosa di sicurezza rossa
- Pulsante ON/OFF con 3 modalità funzionamento: fissa, flash rapido, flash lento
- Batterie: 1xCR2032 (inclusa)



CODICE	EAN	IMBALLO	PREZZO € IVA ESCLUSA
8710498	6435200213402	6	4,50



## FASCIA RUNNING WHITE

NEW

CATEGORIA SCONTO 16

- Fascia luminosa di sicurezza bianca
- Pulsante ON/OFF con 2 modalità funzionamento: fissa, flash
- Batterie: 2xCR2032 (incluse)



CODICE	EAN	IMBALLO	PREZZO € IVA ESCLUSA
8710499	6435200229472	6	5,30



## FLASHLIGHT TORCIA PORTATILE A LED RICARICABILE

CATEGORIA SCONTO 16

- Corpo in robusto materiale antiurto e antiscivolo gommato colore rosso/nero.
- Interruttore a due posizioni: strong light/weak light
- Super bright LED 1x5W
- Durata batteria 4 ore alla massima intensità e 16 ore alla minima intensità.
- Batteria ricaricabile 4V 6Ah
- Dimensioni 218x122x186.
- Pratica cinghia tracolla.
- Caricabatterie da rete compreso

CODICE	EAN	IMBALLO	PREZZO € IVA ESCLUSA
LED15	8031453011970	20	27,00

**AIRAM HEADLIGHT**

NEW

CATEGORIA SCONTO 16



- Lampada headlight con inclinazione regolabile
- Funzioni: luce bianca al 100% - luce bianca al 50% - luce rossa al 100% e modalità SOS
- Durata fino a 30.000h
- 1W - 80lm., non intercambiabile
- Batterie 3XLR03 (non incluse)



CODICE	EAN	IMBALLO	PREZZO € IVA ESCLUSA
LED25	6435200191328	6	7,50

**AIRAM POWER HEADLIGHT**

NEW

CATEGORIA SCONTO 16



- Lampada headlight con inclinazione regolabile
- Funzioni: luce bianca al 100% - luce bianca al 40% - luce rossa al 100% e luce rossa intermittente
- Durata fino a 30.000h
- 3W - 200lm CREE led, non intercambiabile
- Batterie: 3XLR03 (non incluse)



CODICE	EAN	IMBALLO	PREZZO € IVA ESCLUSA
LED26	6435200204301	6	14,00

**LANTERNA DA CAMPEGGIO**

NEW

CATEGORIA SCONTO 16

- Lanterna a led da campeggio portatile con maniglie in gomma per trasporto e attacco da sospensione
- Funzioni: 3 livelli di luminosità 100%,50%,25% - led rosso fisso o SOS
- Indicatore di carica della batteria
- Tempo d'esercizio: c.a. 20h
- Protezione: IP44
- Batterie: 3 x LR20/D (non incluse)

CODICE	EAN	IMBALLO	PREZZO € IVA ESCLUSA
8710449	6435200205292	4	21,80





## LANTERNA DA CAMPEGGIO CON RICARICA USB

NEW

CATEGORIA SCONTO 16

- Lanterna a led da campeggio portatile con maniglie in gomma per trasporto e attacco da sospensione
- Funzioni: 3 livelli di luminosità
- Dotata di batteria ricaricabile e porta USB per ricarica dispositivi
- 42 - 4 LED - max 1000lm
- Tempo di ricarica: 8h
- Durata: 3h (massima luminosità), 65h (minima luminosità)

CODICE	EAN	IMBALLO	PREZZO € IVA ESCLUSA
8710479	6435200218834	6	54,00



## MEGA700 TORCIA LED FLASHLIGHT 700LM

NEW

CATEGORIA SCONTO 16

- Torcia portatile in alluminio
- Funzioni: 2 livelli di luminosità con funzione zoom
- 10W - 700lm
- Batterie: 6xAA (non incluse)

CODICE	EAN	IMBALLO	PREZZO € IVA ESCLUSA
8710488	6435200218919	6	25,70



## MEGA800 TORCIA LED FLASHLIGHT 800LM CON RICARICA USB

NEW

CATEGORIA SCONTO 16

- Torcia portatile in alluminio
- Funzioni: 2 livelli di luminosità con funzione zoom
- 800lm
- Batteria ricaricabile tramite porta USB
- Ricarica: 4-6h
- Durata: 2h (massima luminosità), 4h (minima luminosità)

CODICE	EAN	IMBALLO	PREZZO € IVA ESCLUSA
8710489	6435200218926	6	39,00



**GUMLIGHT HI-POWER**

CATEGORIA SCONTO 16



- Torcia con interruttore a pulsante antiurto ed impermeabile
- Cinturino di sicurezza
- Illuminazione a 9 LED
- Corpo in gomma nera o rossa antisdrucchiolo.
- Disponibile in due colori: nero o rosso
- Versione nera disponibile anche con supporto per bici
- Batterie: 3xAAA (non include)

	CODICE	EAN	IMBALLO	PREZZO € IVA ESCLUSA
<b>BLISTER</b>	LED13N	8031453000912	12	4,10
<b>BLISTER</b>	LED13R	8031453000929	12	4,10
<b>BLISTER</b>	LED13NS	8031453000950	12	5,05

**EXPO TORCE LED COLORI VARI 12 PEZZI**
**NEW**

CATEGORIA SCONTO 16

- Torcia in alluminio con impugnatura in gomma
- Cinturino di sicurezza
- 1W - 80lm
- 12 torce (4 rosse - 4 verdi - 4 blu)
- Batterie: 3xAAA (non include)

	CODICE	EAN	IMBALLO	PREZZO € IVA ESCLUSA
	8710490	6432500151568	1	80,70

**EXPO TORCE IN GOMMA COLORI VARI 12 PEZZI**

CATEGORIA SCONTO 16



- Torcia con interruttore e pulsante antiurto e impermeabile
- Corpo in gomma antisdrucchiolo e con cinturino di sicurezza
- 12 torce (3 rosse - 3 nere - 3 blu - 3 gialle)
- Batterie: 3xAAA (non include)

	CODICE	EAN	IMBALLO	PREZZO € IVA ESCLUSA
	LED13KIT	8031453002909	1	47,00



## EXPO WORKLIGHT LED COLORI VARI 9 PEZZI

NEW

CATEGORIA SCONTO 16

- Lampada da lavoro con staffa magnetica orientabile fino a 180°
- Funzioni: modalità torcia o modalità lanterna
- Composizione: 9 torce (3 rosse - 3 nere - 3 blu)
- Corpo in gomma antidrucciolo e con gancio per sospensione
- 3W - 250lm
- Batterie: 3xAAA ( incluse)

CODICE	EAN	IMBALLO	PREZZO € IVA ESCLUSA
8710478	6435200218810	1	136,00

## PORTACHIAVI LED

NEW

CATEGORIA SCONTO 16



- Due portachiaavi corpo in alluminio
- Blister in due colori: viola e azzurro
- 1,5 W - 14lm
- Batterie: 4xLR41 (incluse)

CODICE	EAN	IMBALLO	PREZZO € IVA ESCLUSA
8710474	6435200145420	12	6,90

BLISTER

## PEN LED LIGHT

NEW

CATEGORIA SCONTO 16



- Penna luminosa
- Batteria: 1xAAA (non inclusa)

CODICE	EAN	IMBALLO	PREZZO € IVA ESCLUSA
8710460	6435200213464	6	4,90

BLISTER

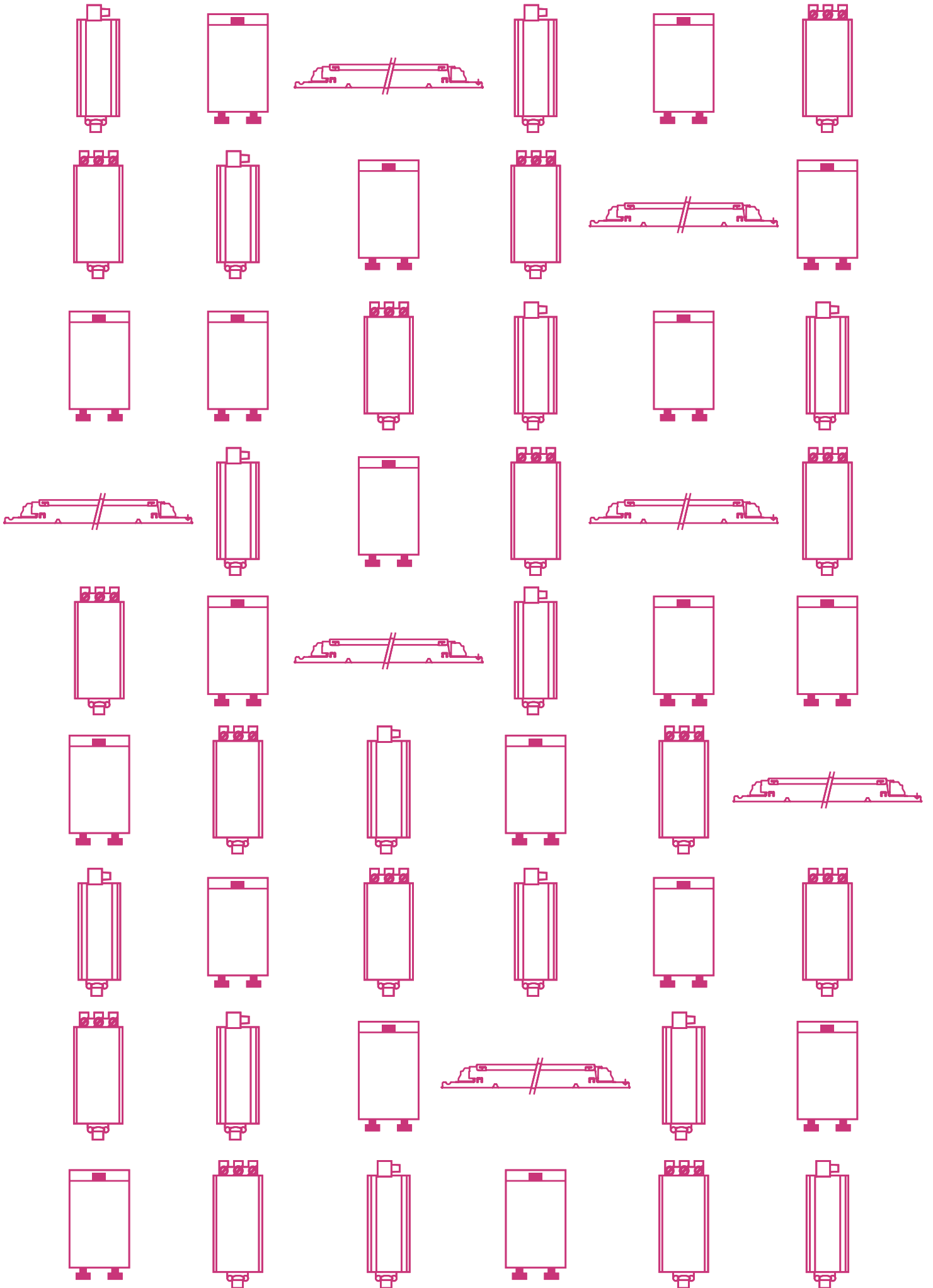

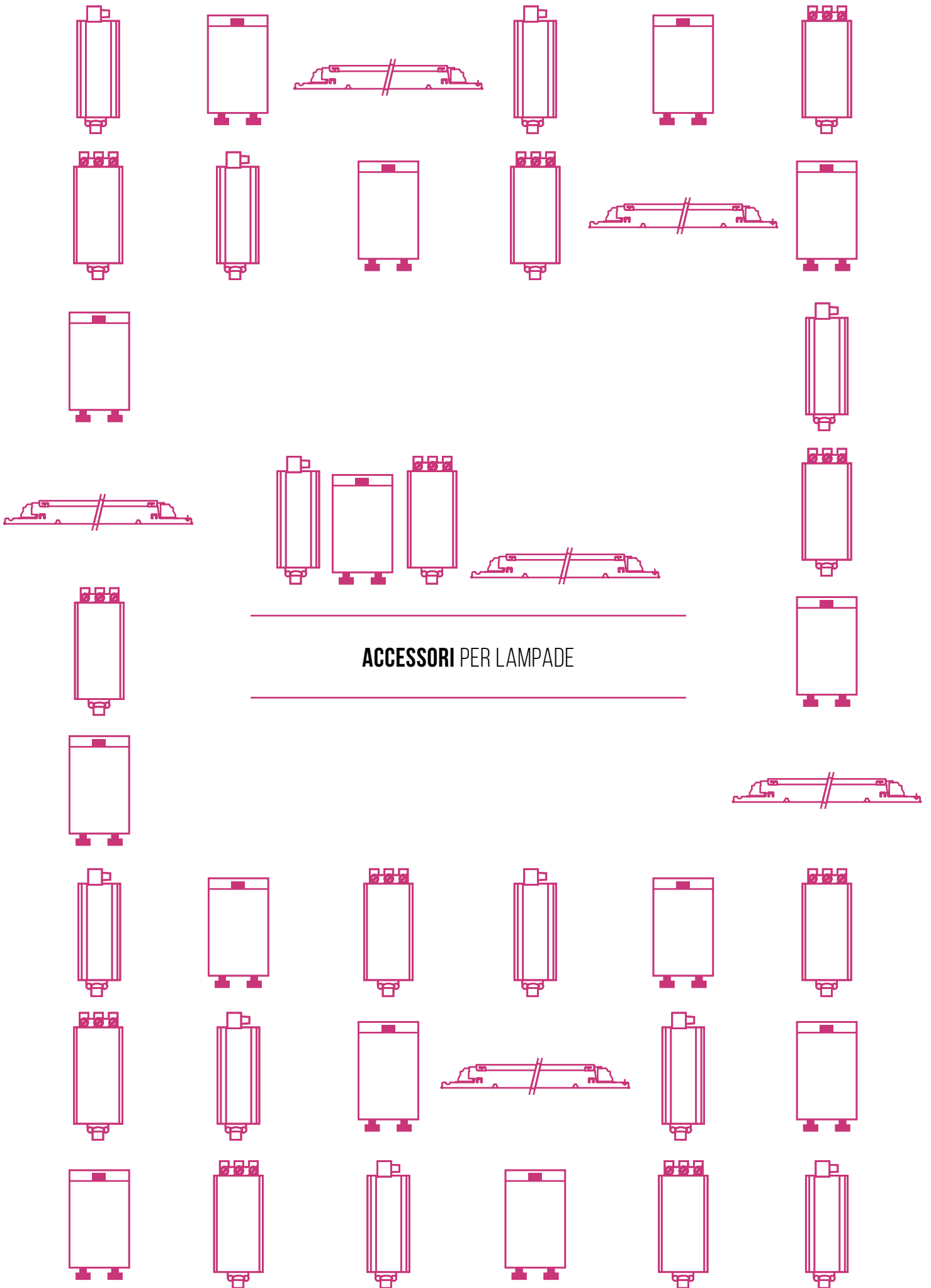

**ACCESSORI PER LAMPADE**

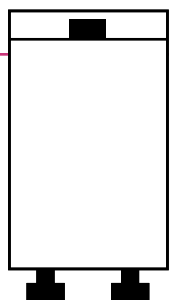
**STARTER NORMALI**

CATEGORIA SCONTO 17

	TIPO	ALIMENTAZIONE	CODICE	IMBALLO	PREZZO € IVA ESCLUSA
PER LAMPADE FLUORESCENTI LINEARI DA 4W A 20W (26-38 MM) CIRCOLARI DA 22W.	ST20	230 V - 50/60 HZ	<b>ST20</b>	25	0,45
PER LAMPADE FLUORESCENTI LINEARI DA 4W A 65W (26-38 MM) CIRCOLARI DA 22W A 40W.	ST65	230 V - 50/60 HZ	<b>ST65</b>	25	0,45

**ALIMENTATORI ELETTRONICI PER LAMPADE FLUORESCENTI T8**

CATEGORIA SCONTO 17



	TIPO	ALIMENTAZIONE	CODICE	IMBALLO	PREZZO € IVA ESCLUSA
PER LAMPADE FLUORESCENTI LINEARI 1X18 W	REL - 18	220-240 V 50/60 HZ	<b>REL18</b>	10	31,50
PER LAMPADE FLUORESCENTI LINEARI 2X18W	REL - 18P2	220-240 V 50/60 HZ	<b>REL18P2</b>	10	35,40
PER LAMPADE FLUORESCENTI LINEARI 1X36W	REL - 36	220-240 V 50/60 HZ	<b>REL36</b>	10	31,50
PER LAMPADE FLUORESCENTI LINEARI 2X36W	REL - 36P2	220-240 V 50/60 HZ	<b>REL36P2</b>	10	35,40
PER LAMPADE FLUORESCENTI LINEARI 1X58W	REL - 58	220-240 V 50/60 HZ	<b>REL58</b>	10	31,50
PER LAMPADE FLUORESCENTI LINEARI 2X58W	REL - 58P2	220-240 V 50/60 HZ	<b>REL58P2</b>	10	35,40

## ALIMENTATORI ELETTRONICI PER LAMPADE FLUORESCENTI T5

CATEGORIA SCONTO 17



	TIPO	ALIMENTAZIONE	CODICE	IMBALLO	PREZZO € IVA ESCLUSA
MULTIPOTENZA PER LAMPADE FLUORESCENTI HIGH EFFICIENCY 1X14/21/28/35W.	REL - M	220 -240 V 50/60 HZ	REL35M	10	31,50
MULTIPOTENZA PER COPPIA DI LAMPADE FLUORESCENTI HIGH EFFICIENCY 2X14/21/28/35W.	REL - M2	220 -240 V 50/60 HZ	REL35M2	10	35,40

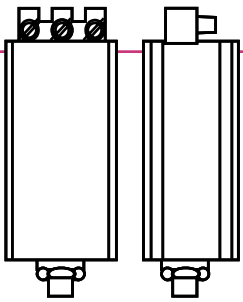

## ACCENDITORI UNIVERSALI PER LAMPADE A SCARICA

CATEGORIA SCONTO 17

	TIPO	ALIMENTAZIONE	CODICE	IMBALLO	PREZZO € IVA ESCLUSA
ACCENDITORE LAMPADE PER SODIO DA 70 A 400 W, PER IODURI METALLICI DA 35 A 400 W, 3 FILI,	IG051	220/230 V - 50/60 HZ	IG051	50	17,20

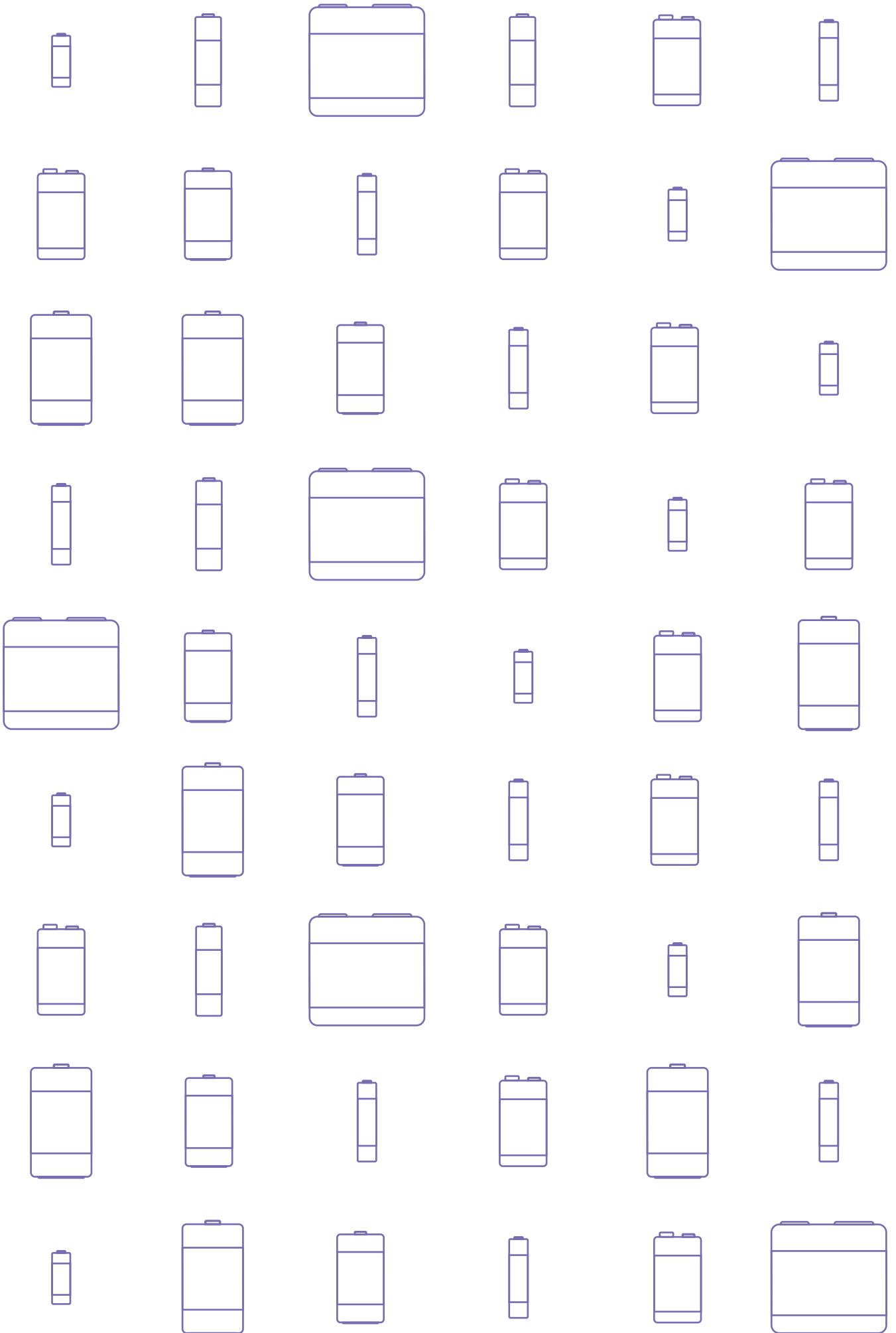





**PILE ELETTRICHE**

**EVOLUTION + ALKALINE**

CATEGORIA SCONTO 15



TIPO	DESCRIZIONE	CONFEZIONE	CODICE	EAN	IMBALLO	PREZZO € IVA ESCLUSA
AAA	MINISTILO EVOLUTION PLUS 1,5 V	BLISTER 4PZ	<b>LR03</b>	6435200194725	10/80	1,78
AA	STILO EVOLUTION PLUS 1,5 V	BLISTER 4PZ	<b>LR6</b>	6435200194749	10/80	1,92
9V	EVOLUTION 9 V	BLISTER 1PZ	<b>6LR61</b>	6435200194763	10/200	2,45

**SUPER ALKALINE MULTIPACK**

CATEGORIA SCONTO 15

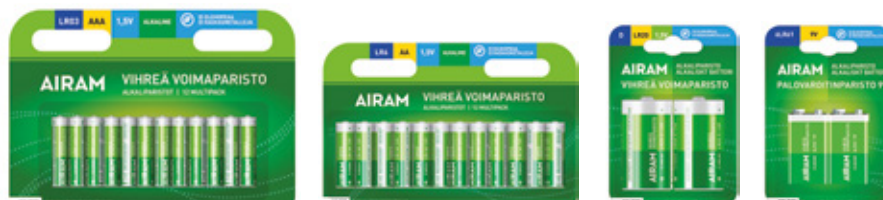

TIPO	DESCRIZIONE	CONFEZIONE	CODICE	EAN	IMBALLO	PREZZO € IVA ESCLUSA
AAA	MINISTILO SUPER AALKALINE PLUS 1,5 V	BLISTER 12PZ	8/64	<b>LR03/12</b>	8/64	3,90
AA	STILO SUPER ALKALINE 1,5 V	BLISTER 12PZ	8/64	<b>LR6/12</b>	8/64	4,10
C	SUPER ALKALINE 1/2 TORCIA	BLISTER 2PZ	10/80	<b>LR14/2</b>	10/80	3,65
D	SUPER ALKALINE TORCIA	BLISTER 2PZ	10/80	<b>LR20/2</b>	10/80	4,50
6LR61	SUPER ALKALINE 9V	BLISTER 2PZ	10/100	<b>6LR61/2</b>	10/100	3,90



## ALKALINE

CATEGORIA SCONTO 15



TIPO	VOLT	DIAMETRO MM	ALTEZZA MM	CONFEZIONE	CODICE	EAN	IMBALLO	PREZZO € IVA ESCLUSA
LR44/A76	1,5	11,56	5,41	BLISTER 1PZ	LR44	-	10	0,36

Piatta per apparecchi fotografici e calcolatori

TIPO	VOLT	DIAMETRO MM	ALTEZZA MM	CONFEZIONE	CODICE	EAN	IMBALLO	PREZZO € IVA ESCLUSA
E23A	12,00	10,00	28,00	BLISTER 1PZ	E23A	-	100	0,75

Tipo stilo per apparecchi fotografici e calcolatori



## LITHIUM

CATEGORIA SCONTO 15



TIPO	VOLT	DIAMETRO MM	ALTEZZA MM	CONFEZIONE	CODICE	EAN	IMBALLO	PREZZO € IVA ESCLUSA
CR2016	3,00	20,00	1,60	BLISTER 1PZ	CR2016	-	10	0,54
CR2025	3,00	20,00	2,50	BLISTER 1PZ	CR2025	-	10	0,63
CR2032	3,00	20,00	3,20	BLISTER 1PZ	CR2032	-	10	0,57
CR123A	3,00	16,89	34,00	BLISTER 1PZ	CR123A	-	10	3,85
2CR5	6,00	17,10 X 34,00	45,10	BLISTER 1PZ	2CR5	-	10	16,10

**FLUSSO LUMINOSO****220**  
L u m e n

La quantità totale di luce emessa, o flusso luminoso, si misura in lumen (lm). Il numero di lumen emessi è il parametro fondamentale che permette al consumatore di scegliere una lampada in funzione del suo impiego.

**INTENSITÀ MASSIMA****1100** cd

Nelle lampade con emissione direzionale, oltre alla quantità totale di luce emessa (lumen), viene anche indicata l'intensità massima espressa in candele (cd).

**AMPIEZZA FASCIO LUMINOSO****160°**

Nelle lampade con emissione direzionale è indicata l'ampiezza del fascio luminoso espressa in gradi.

**EQUIVALENZA CON SORGENTE TRADIZIONALE****12W-**  
**60** w

Il Watt (W) è l'unità di misura della potenza elettrica assorbita. A sinistra è indicato il consumo della lampada mentre a destra è indicato il consumo (maggiore) di una sorgente tradizionale, incandescente od alogena, che produce un flusso luminoso equivalente.

**COLORE DELLA LUCE****3000 K****LUCE CALDA**  
WARM WHITE

Una luce bianca viene caratterizzata dalla Temperatura di Colore, espressa in Kelvin (K). Una luce calda ha una temperatura di colore più bassa, tipicamente 2700-3000K, mentre una luce fredda ha una temperatura di colore elevata (5000-6500K). L'imballo riporta sia la descrizione sia la scala graduata con il valore esatto.

**TEMPO DI AVVIO****INSTANT** 

Indica il tempo necessario a raggiungere il 60% dell'emissione luminosa a regime.

**VITA NOMINALE****15.000 H**  
**YEARS\***

Indica la durata prevista a cui sopravvive il 50% delle lampade in un lotto campione. Viene espresso in ore e per comodità viene anche indicata l'equivalenza in anni, dove si usa la conversione 1000 ore = 1 anno (cioè 2,7 ore di utilizzo medio giornaliero). Nel caso di lampade LED, si considera la lampada esaurita quando il flusso luminoso si abbassa del 30% rispetto ai valori iniziali.

**ACCENSIONI** **30.000**

Accensioni e spegnimenti ripetuti possono danneggiare la lampada. Viene riportato il numero di accensioni per cui la lampada è collaudata.

**CONTENUTO DI MERCURIO****MERCURY** **2,5** MG **MERCURY** **FREE**

Contenuto massimo di mercurio in una lampada. Nel caso di lampade senza mercurio, sulla scatola è stampata l'icona verde 'HG FREE'.

**U.V. E I.R.****U.V. I.R.** **FREE**

Lampada con tecnologia per la soppressione di emissioni Ultraviolette.

**UTILIZZO CON DIMMERS** **DIMMABLE**  **NOT DIMMABLE**

Il simbolo indica se la lampada può essere o non può essere utilizzata con regolatori di luce.

**UTILIZZO IN APPARECCHI APERTI**

Lampada adatta all'impiego in apparecchi sprovvisti di vetro di protezione.



Lampada con doppio fusibile all'interno del corpo



Apparecchio con la possibilità di regolare il tempo di accensione



Lampada con flusso luminoso di tipo direzionale



Apparecchio con la possibilità di regolare la distanza di rilevamento movimento



Temperatura ambiente entro la quale l'apparecchio può lavorare correttamente



Apparecchio con rilevatore di movimento a microonde



Apparecchio con grado di protezione agli agenti esterni IP20



Sensore passivo ad infrarossi



Apparecchio con grado di protezione agli agenti esterni IP44



Apparecchio con accensione automatica con la possibilità di regolare la sensibilità alla luce



Apparecchio con grado di protezione agli agenti esterni IP65



Collegamento alla presa dell'auto a 12V possibile.



Alta resa dei colori



Tempo di ricarica della batteria



Apparecchio provvisto di collegamento di messa a terra di protezione



Lampada con tecnologia a ioduri metallici



Apparecchio provvisto di collegamento di messa a terra di protezione



Lampada con tecnologia al ioduri metallici e bruciatore ceramico



Pack Blister



Lampada con tecnologia al sodio



Collegamento a tensione di rete possibile

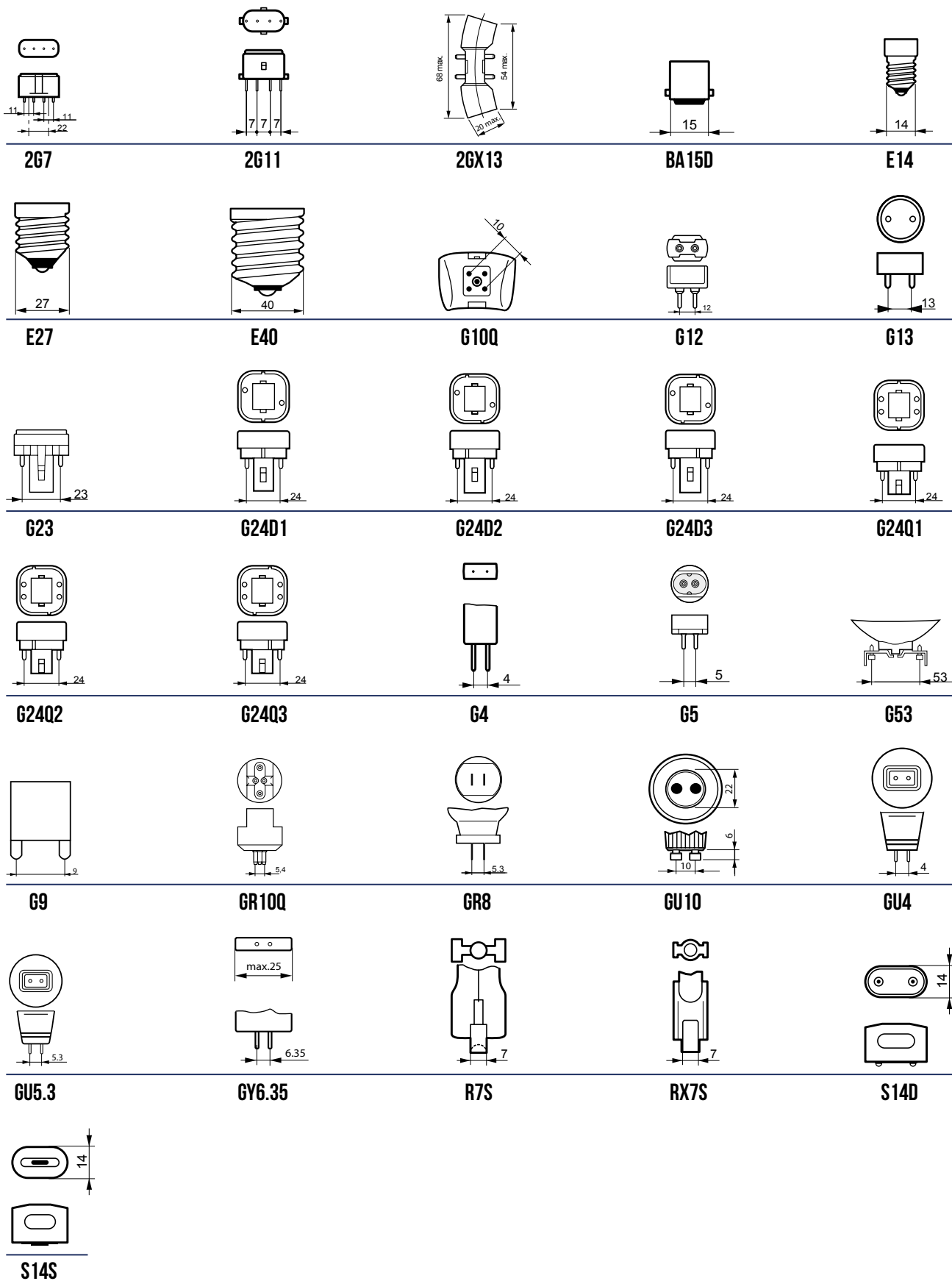

1. Gli ordini sono subordinati all'accettazione del fornitore. Le offerte ed accettazioni di ordini si intendono ai prezzi ed alle condizioni di vendita in vigore al momento della spedizione della merce, salvo disponibilità. Gli ordini anche se raccolti tramite il nostro personale di vendita, sono vincolati all'accettazione da parte di BOT LIGHTING Srl, che può essere anche parziale.
2. Alla Venditrice non potrà essere addossata alcuna responsabilità per mancata accettazione, ovvero per mancata o ritardata fornitura dei prodotti oggetto dello stesso. L'accettazione e l'esecuzione dell'ordine sono specificatamente subordinate alla disponibilità dei prodotti ordinati nonché all'assenza di circostanze che possano comunque influire sulla reperibilità degli stessi e sulla loro tempestività di consegna. I termini di consegna sono indicativi e l'acquirente non può pretendere la rifusione di danni in caso di ritardi nelle consegne per cause non imputabili al fornitore. Gli eventuali ritardi nelle consegne, così come le interruzioni e/o sospensioni totali o parziali delle forniture, anche se non dovute a causa di forza maggiore e/o caso fortuito, non daranno diritto al risarcimento di danni e/o indennizzi di qualsiasi tipo, ivi inclusi quelli diretti, indiretti e consequenziali, nonché interessi.
3. La merce viaggia a rischio e pericolo dell'acquirente e in caso di furti, manomissioni, l'acquirente dovrà rivolgersi esclusivamente al vettore. In qualsiasi caso le anomalie riscontrate alla consegna dovranno essere notificate a BOT LIGHTING Srl con la seguente modalità:
  - nel caso di colli sfusi verificare sempre all'atto della consegna il numero esatto dei colli e le eventuali rotture. Eventuali riserve precise dovranno sempre esser verbalizzate sul documento di trasporto e sull'eventuale bollettino del trasportatore.
  - nel caso di bancali e quindi di impossibilità al controllo immediato alla consegna è necessario accettare la consegna stessa con "riserva di verifica" da esser segnalata nell'apposito riquadro del documento di trasporto e nell'eventuale bollettino del corriere.I reclami dovranno pervenire a BOT LIGHTING Srl entro 3 giorni dal ricevimento del materiale.
4. Non appena ricevuti i prodotti, l'Acquirente sarà tenuto a verificare lo stato, la quantità della fornitura e la sua rispondenza alla bolla di consegna. Eventuali reclami in merito alla qualità, quantità, tipo del prodotto, dovranno essere fatti per iscritto entro 5 (cinque) giorni dalla data di ricevimento della merce. Decorso tale termine, fatte comunque salve le diverse condizioni di garanzia previste per i singoli prodotti, nessun reclamo potrà essere avanzato sia per la sostanza e la qualità della merce, sia per le condizioni in genere della stessa.
5. Eventuali difetti di fabbricazione dovranno essere tempestivamente denunciati e, dopo verifica di accertamento, saranno dal fornitore accreditati in toto od in parte, oppure sostituiti. Eventuali resi dovranno esser preventivamente concordati con il fornitore e si intendono "salvo verifica".
6. I prezzi di listino formulati si intendono per merce franca presso il deposito del fornitore; imballi speciali, assicurazione, resa e trasporto, imposte e tasse (IVA, ecc.) sono addebitabili a parte. Il prezzo indicato in tabella è da considerarsi come prezzo suggerito al pubblico.
7. Nel commercio dei prodotti, oggetto del contratto, l'acquirente si asterrà da qualsiasi atto contrario ai principi della concorrenza leale, in conformità alle leggi, ai regolamenti nonché agli usi, in quanto compatibili.
8. Il pagamento della merce, nei termini ed alle condizioni di volta in volta stabiliti, dovrà esser effettuato presso il domicilio del fornitore, oppure ad un incaricato a ciò espressamente delegato. In quest'ultimo caso i pagamenti non si intendono effettuati finché le relative somme non pervengano alla sede centrale. Il mancato rispetto delle condizioni di pagamento stabilite o pagamenti differiti rispetto alle condizioni inizialmente concordate, determineranno l'applicazione degli interessi di mora, decorrenti dalla data di scadenza di pagamento della fattura e da determinarsi in base alla normativa di legge al momento vigente. In caso di controversia, per qualsiasi ragione, l'acquirente non ha alcun diritto di ritardare o di rifiutare il pagamento delle fatture scadute. Eventuali sconti cassa, nonché abbuoni o premi di qualsiasi natura saranno riconosciuti a condizione che il cliente non abbia pagamenti in sospeso e si intenderanno automaticamente decaduti e revocati in caso di mancato o ritardato pagamento. Ci riserviamo la facoltà di non dare esecuzione agli ordini di acquirenti che non abbiano provveduto al puntuale pagamento di forniture precedenti.
9. In caso di controversie si stabilisce la competenza esclusiva del Foro di Venezia.
10. La BOT LIGHTING Srl è impegnata a sviluppare e migliorare i propri prodotti. Per questa ragione tutte le descrizioni di questo catalogo-listino sono intese come guida generale e le specifiche possono essere cambiate di volta in volta nell'interesse del miglioramento del prodotto. Inoltre, eventuali modifiche sulle caratteristiche e sulla gamma di prodotti commercializzati che possono essere apportati dai produttori in qualsiasi momento senza preavviso, escludono la Bot Lighting Srl da alcuna responsabilità.



A large area of the page is filled with horizontal dotted lines, providing a template for handwritten notes.









# BOTLIGHTING

**SHOT**  
BOT LIGHTING

**AIRAM**  
BOT LIGHTING

**Bot Lighting srl** - Via Lombardia n 37/39  
30030 Cazzago di Pianiga (VE) - Italy  
T. +39.041.51.29.411 - F. +39.041.51.01.715  
[www.botlighting.it](http://www.botlighting.it) - [info@botlighting.it](mailto:info@botlighting.it)  
[ordini@botlighting.it](mailto:ordini@botlighting.it)