

.016

CATALOGO GENERALE



 **ATHENA**  
*così in luce*

# AZIENDA

La nostra azienda, presente sul mercato dal 1972 concentra nella propria sede tutte le fasi di lavorazione dei prodotti, dalla progettazione alla costruzione e all'assemblaggio.

La massima professionalità viene impiegata nella creazione e nella produzione dei nostri articoli per garantirne la più accurata qualità e la massima sicurezza. Seguendo tale impegno tutti i nostri prodotti hanno raggiunto la marcatura europea CE attestante la conformità alle norme di sicurezza. Da sempre a fianco della clientela per offrire la massima disponibilità e professionalità ad aiutare a risolvere ogni problematica in campo illuminotecnico e esecuzioni speciali o contract.

Collezioni di lampade da terra, lampade da parete, plafoniere, sospensioni e lampade da tavolo, sistemi su cavo a 220V e 12V. I nuovi sistemi e faretti a incasso a LED completano la gamma della produzione, che arreda ambienti sia moderni che in stile. L'evoluzione della nuova tecnologia LED si concretizza nella produzione di nuove collezioni e nei nuovi sistemi con sorgenti luminose a LED. L'esperienza dei nostri tecnici e designer, la ricerca di nuovi materiali, l'utilizzo delle nuove tecnologie di costruzione caratterizzano l'unicità delle nostre collezioni.

Nella ricerca costante della migliore funzionalità e qualità dei nostri prodotti, si riserva in qualsiasi momento la facoltà di apportare modifiche e migliorie sugli stessi senza alcun obbligo di avviso alla Clientela.

*Our firm, on the market since 1972 converges all the manufacturing cycle of its production, from the design to the production and assembly, in its factory.*

*Great professionalism is used in the creation and production of our products to guarantee top quality and maximum safety.*

*Following that course, all our products have obtained the European EC mark, certifying their compliance with safety regulations. Always working alongside customers to offer maximum availability and professionalism, helping them find solutions to any problem that may arise in the field of lighting, for special executions or contracts.*







*Collections of floor lamps, wall lights, ceiling light fixtures, pendants and table lamps that furnish both modern and classical surroundings. Evolution of the new led technology has led to the creation of new collections and new systems using led light sources. The experience of our technicians and designers, the search for new materials, the use of new manufacturing technologies characterize the unicity of our collections.*

*In the continuous engagement to improve the performance and quality of our products, we reserve the right to make modifications and improvements to them without prior notice to our Customers.*

# INDICE

TECNICO	Sigma Led 1	pag. 13
	Sigma Led 2	pag. 15
	Omega Led	pag. 16
	Delta Led - Touch - Mov	pag. 18
	Tau Led - Touch - Mov	pag. 22
	Sihon Led - Touch - Mov	pag. 24
	Etha	pag. 28
	Omega Wet	pag. 30
	Sigma	pag. 33
	Sigma 3	pag. 34
	Omega	pag. 36
	Delta	pag. 37
	Tau	pag. 38
	Kappa	pag. 40
	Piatto	pag. 41
	Sihon	pag. 42
	Strip led	pag. 44
	Focus 300	pag. 52
	Focus 160	pag. 66
	Focus 1	pag. 72
	Twin	pag. 78
Flight System	pag. 79	
DECORATIVO	Dadajè	pag. 104
	Prisma	pag. 112
	Milo	pag. 114
	Giotto	pag. 118
	Degas	pag. 124
	Mondrian	pag. 136
	Monet	pag. 138
	Picasso	pag. 144
	Riflessi	pag. 148
	Kite	pag. 152
	Magic	pag. 158
	Onda	pag. 160
	Alpha	pag. 162
	Beta	pag. 164
	Metal	pag. 166
	Arte	pag. 168
Faretti	pag. 172	
INCASSO	Orione	pag. 178
	Pegaso	pag. 198
ACCESSORI		pag. 202

### Finitura prodotti - Fitting colours

	1 cromo-chrome
	2 acciaio satinato-chrome sarined
	3 oro zecchino-gold
	5 bianco-white
	6 trasparente-clear
	7 grigio metallizzato-aluminium met
	9 nero-black

### Finitura inserti - Details colours

	1 bianco-white
	2 blu-blue
	4 verde-green
	5 cristallo-crystal colour
	6 ambra giallo-amber yellow
	7 arancio-orange
	8 rosso-red

### Finitura vetri - Glass colours

	1 bianco-white
	2 blu-blue
	4 verde-green
	5 cristallo-crystal colour
	6 ambra giallo-amber yellow
	8 rosso-red
	9 nero-black









### Tonalità colore LED - Led color tone

	0 Dynamic White
	1 Natural White
	2 Blue
	3 RGB White
	4 Green
	5 Cold White
	6 Warm White
	7 Yellow
	8 Red
	9 RGB

### Ottica - Optics







- 1 20° - 34°
- 2 35° - 40°
- 4 55° - 60°

### Simboli e marchi - Symbols and marks

	I prodotti sono conformi alle normative EMC / The product comply with EEC directives. La marcatura CE garantisce la libera circolazione dei prodotti sul mercato europeo. EEC marking guarantees the free circulation of the products in the European market.
	Apparecchi dotati di morsetto di terra o cavo completo di conduttore di terra. Equipment with metal parts connected to the earth circuit.
	Apparecchi dotati di doppio isolamento e senza dispositivi di messa a terra. Equipment with double insulation and without earthing devices.
	Apparecchi alimentati con tensione inferiore a 50V. Equipment powered with safety voltage lower than 50V.
	Apparecchi idonei per essere installati su superfici infiammabili. Equipment can be used on inflammable surfaces.
	Dimensione del foro di incasso / Hole dimensions
	Peso netto in gr. del prodotto / Net weight in gr. of the product
	Calpestabile / Walkable

### Indice protezione IP ... - Resistenza alla penetrazione di solidi (1^ cifra) e liquidi (2^ cifra)

Protective degree IP ... Resistance of the fitting to the penetration of solid and liquids

IP 1..		Protetto contro la penetrazione di corpi solidi di dimensione superiore a 50 mm. Protected against penetration of solids larger than 50 mm.
IP 2..		Protetto contro la penetrazione di corpi solidi di dimensione superiore a 12 mm. Protected against penetration of solids larger than 12 mm.
IP 3..		Protetto contro la penetrazione di corpi solidi di dimensione superiore a 2,5 mm. Protected against penetration of solids larger than 2,5 mm.
IP 4..		Protetto contro la penetrazione di corpi solidi di dimensione superiore a 1 mm. Protected against penetration of solids larger than 1 mm.
IP 5..		Protetto contro la penetrazione della polvere. Protected against penetration of dust.
IP 6..		Protetto completamente contro la penetrazione della polvere. Completely protected against penetration of dust.
IP ..0		Non protetto / Unprotected
IP ..1		Protetto contro le cadute verticali di gocce d'acqua. Protected against vertical falling of water drops.
IP ..2		Protetto contro la caduta d'acqua con inclinazione max di 15°. Protected against falling of water with 15° maximum angle.
IP ..3		Protetto contro la pioggia / Protected against rain.
IP ..4		Protetto contro gli spruzzi / Protected against sprinklings.
IP ..5		Protetto contro i getti d'acqua / Protected against water jets.
IP ..6		Protetto contro le ondate / Protected against heavy waves.
IP ..7		Protetto contro l'immersione temporanea. Protected against temporary immersion.

SEZIONE CATALOGO

NOME COLLEZIONE

DESCRIZIONE PRODOTTO

FOTO PRODOTTO

ESEMPIO COMPOSIZIONE CODICE

DISEGNI TECNICI QUOTATI (mm)

CODICE PRODOTTO E FINITURA

POTENZA PRODOTTO

TONALITÀ COLORE LED

OTTICA

MARCHI E SIMBOLI

ACCESSORI

INCASSO | 189

## ORIONE

Design Athina

Faretto orientabile da incasso. Corpo faretto in ottone. Ghiera in metallo. Applicazione con molle per controsoffitto.  
Adjustable recessed spotlight. Copper structure, metal front piece. Application with springs for false ceiling.



Driver non incluso.  
Solo collegamento in serie.  
Driver not included - Only serial connection

Composizione codice (rispettare la sequenza):  
11401 - cromo - warmwhite - 38° = 11401.1.6.2



**11401 1** cromo - chrome  
**11401 2** nichel satinato - nickel  
**11401 5** bianco opaco - matt white

1x9,8W 350mA

Colori led - led colours

1 Natural white 4000°K lm500 6 Warm white 3000°K lm540 9 RGB 11.5W H81 3 LED 45°

Optica - Optics

1 18° 2 38° 3 54°



75 ACCESSORI



**11402 1** cromo - chrome  
**11402 2** nichel satinato - nickel  
**11402 5** bianco opaco - matt white

1x9,8W 350mA

Colori led - led colours

1 Natural white 4000°K lm810 6 Warm white 3000°K lm740

Optica - Optics

1 18° 2 38° 3 54°



Utilizzare alimentatori 350mA da pag. - Schemi assemblaggio da pag.  
Use drivers 350mA from page - Assembly schemes from page

DECORATIVO | 117

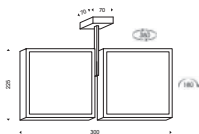

**572151** bianco NW - white  
220/240V 26W Dimmable con Tracdimmmer

Colori led - led colours  
1 Natural white 4000°K 2400lm

**572156** bianco WW - white  
220/240V 26W Dimmable con Tracdimmmer

Colori led - led colours  
6 Warm white 3000°K 2000lm

Colori policarbonato - Polycarbonate colours

1 Trasparente - Transparent 2 Blu - Blue 7 Arancio - Orange 6 Giallo - Yellow 8 Rosso - Red

LED CRI >80



FOTO PRODOTTO

DISEGNI TECNICI QUOTATI (mm)

CODICE PRODOTTO E FINITURA

TONALITÀ COLORE LED

COLORI INSERTI

MARCHI E SIMBOLI

## PROFILI E STRIP | Profiles and strip

### PROFILI LED



SIGMA 13



OMEGA 16



DELTA 18



TAU 22



SIHON 24



ETHA 28



OMEGA WET 30

### PROFILI



SIGMA 33



SIGMA 3 34



OMEGA 36



DELTA 37



TAU 38



KAPPA 40



PIATTO 41



SIHON 42

### STRIP



19,2W 44



RGB/W 45



DYNAMIC/W 45



14,4W 46



9,6W 48

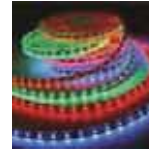

4,8W 49

## SISTEMI | Systems

### FOCUS 300



0211 63



0234 60



0239 56



0240 59



0242 59



0243 58



0251 60



0272 62



0282 62

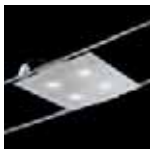

0289 52



0290 54



0291 55

### FOCUS 160



0434 70



0457 66



0458 68



0472 70



0490 69

### FOCUS 1



0134 73



0172 72



0190 73



0191 74

SISTEMI | *Systems*

## TWIN &amp; FLIGHT



0353

84



0354

84



0355

84

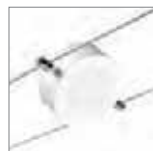

0358

80

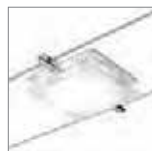

0357

82



1410

90



1911

86



2010

86



3010

89



3110

87



3310

87



4511

90



4611

89



0630

92



0632

92



0633

92



0634

92



0639

93



0640

93

SOSPENSIONI | *Suspensions*

DADAJÈ

106



DEGAS

124



DEGAS

126



FOCUS

77



GIOTTO

118



KITE

152



KITE

157



MONET

141



ONDA

160

DA SOFFITTO | *Ceiling Fixtures*

DADAJÈ

108



DADAJÈ

110



DADAJÈ

110



KITE

155



MAGIC

158



MILO

117



MONDRIAN

136



MONDRIAN

136



MONET

142



ONDA

161



PRISMA

113



RIFLESSI

151



DA PARETE | *Wall Fixtures*

ARTE 168



ARTE 170



ARTE 169



ARTE 171



ARTE 171



ALPHA 163



BETA 164



DADAJÈ 104



DADAJÈ 105



DADAJÈ 107



DADAJÈ 107



DEGAS 130



KITE 156



MAGIC 158



METAL 166



METAL 166



METAL 167



MILO 116



MILO 115



MONDRIAN 137



PICASSO 145



PRISMA 112

DA TAVOLO | *Table Fixtures*

ALPHA 162



BETA 165

DA TERRA | *Standard Fixtures*

DEGAS 131



DEGAS 132



KITE 154

FARETTI | *Spot*

ALPHA 163



ARTE 170



BETA 164



FARETTI 172



FARETTI 173



FARETTI 175



FARETTI 174



FARETTI 172



FARETTI 173



FARETTI 175



FARETTI 174

INCASSO | *Recessed spots*



11301 179



11302 180



11303 181



11304 183



11306 184



11307 185



11462 186



11401 189



11411 190



11421 191



11431 192



11463 187



11464 187



11461 194



11471 195



11481 196



1011 200



1041 200



1007 198



1037 198



1009 199



1039 199

TECNICO  
collection



13  
**SIGMA**  
LED 1



33  
**SIGMA**



44  
**STRIP**  
LED



15  
**SIGMA**  
LED 2



34  
**SIGMA 3**

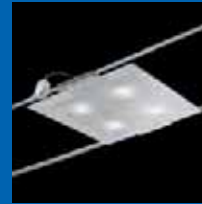

52  
**FOCUS**  
300

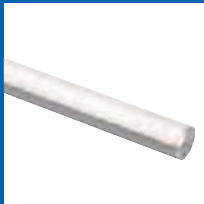

16  
**OMEGA**  
LED



36  
**OMEGA**



66  
**FOCUS**  
160



18  
**DELTA**  
LED  
TOUCH  
MOV



37  
**DELTA**



72  
**FOCUS 1**



22  
**TAU**  
LED  
TOUCH  
MOV



38  
**TAU**



78  
**TWIN**



24  
**SIHON**  
LED  
TOUCH  
MOV



40  
**KAPPA**



79  
**FLIGHT**  
SYSTEM



28  
**ETHA**



41  
**PIATTO**



30  
**OMEGA**  
WET



42  
**SIHON**



# SIGMA LED 1

Design Athena

Profilo in alluminio anodizzato completo di strip LED. Schermo in policarbonato, cavo alimentazione mm 2000

Anodized aluminium profile complete with strip led. Polycarbonate screen, wire length mm 2000



A lunghezza massima profilo cm. 400 - per spedizioni max cm. 300

max length cm 400 - for shipment max length cm 300

bianco e nero lunghezza massima profilo cm. 210

white and black max length cm 210

Colori profilo  2 All. anodizzato  5 Bianco  9 Nero  
profile colours anodized al. white black

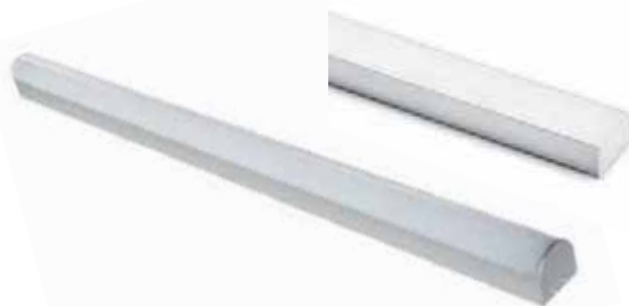

## PROFILI TAGLIATI A MISURA COMPLETI DI STRIP LED

Il codice del prodotto è riferito a 10 cm. di profilo completo di strip led.

Per definire la lunghezza finale del binario considerare la misura di taglio della strip (14,4w ogni 10 cm - 19,2w ogni 2,5cm)

+ 2cm per i tappi di chiusura e il cablaggio.

**Esempio di ordine:** Profilo + strip 14,4w/m cm 128 (profilo cm 128 strip cm 120) Profilo + strip 14,4w/m cm 152 (profilo cm 152 strip cm 150)

**Composizione codice:** profilo bianco-WW-schermo satinato = 9014-5-6-1 cm...

## TAILORED CUT PROFILES COMPLETED WITH LED STRIP

The code of the product is referred to 10cm of it.

To define the final length of the profile consider the cut measure of the strip (14,4w each 10cm - 19,2w each 2,5cm)

+2cm for the closing tops and the wiring

**Example of order:** profile + led strip 14,4w/m cm128 (profile cm128 strip cm120) profile + led strip 14,4w/m cm152 (profile cm152 strip cm150)

**Code composition:** white profile-WW-satinated screen = 9014-5-6-1 cm ...

Sigma Led con strip led **60 led/mt - 14,4W/m Lm/m 1080/1110 24 Vdc**

Durata: 30000 h Temperatura -20 +40°C taglio ogni 10 cm

Sigma Led with strip led **60 led/mt 14,4W/m Lm/m 1080/1110 24 Vdc**

Lasting 30000 h Temperature -20 +40°C Cut every 10 cm

Colori led  1 Natural white  6 Warm white  9 RGB  
led colours 4000-4500°K 2800-3300°K

9014 2 10 cm alluminio - 10 cm anodized alum.

9014 5 10 cm bianco - 10 cm white

9014 9 10 cm nero - 10 cm black

Profilo alluminio montato con strip led **240 led/mt - 19,2W/m Lm/m 1540/1580 24 Vdc**

Durata: 30000 h Temperatura -20 +40°C taglio ogni 2,5 cm

Anodized aluminium profile assembled with strip led **240 led/mt 19,2W/m Lm/m 1540/1580 24 Vdc**

Lasting 30000 h Temperature -20 +40°C Cut every 2,5 cm

Colori led  1 Natural white  6 Warm white  
led colours 4000-4500°K 2800-3300°K

9019 2 10 cm alluminio - 10 cm anodized alum.

9019 5 10 cm bianco - 10 cm white

9019 9 10 cm nero - 10 cm black

Schermo - Screen



1 Satinato



2 Curvo satinato

CE IP 40 LED CRI 75-80



## ACCESSORI



9654

Supporto per sospensione H 2000mm  
Suspension kit H 2000mm



9659

Supporto parete/soffitto orientabile  
Wall/ceiling adjustable kit

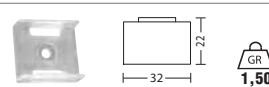

9656

Supporto parete/soffitto  
Wall/ceiling kit

Utilizzare alimentatore da pag. 204  
Schemi assemblaggio da pag. 214  
Use drivers from page 204  
Assembly schemes from page 214



Realizzazione effettuata da Pierlux - Casinalbo



Realizzazione effettuata da Pierlux - Casinalbo

# SIGMA LED 2

Design Athena

Profilo in alluminio anodizzato completo di due strip LED. Schermo in policarbonato, cavo alimentazione mm 2000

Anodized aluminium profile complete with two strip led. Polycarbonate screen, wire length mm 2000

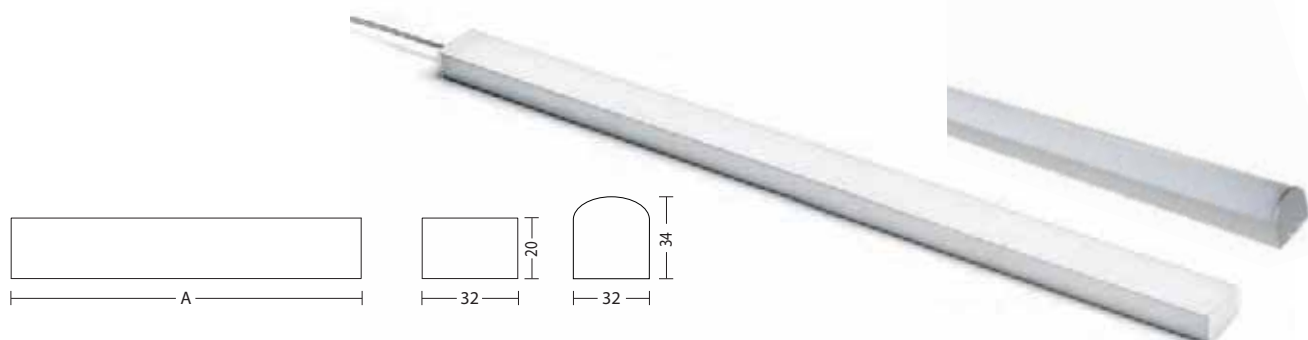

A lunghezza massima profilo cm. 400 - per spedizioni max cm. 300

max length cm 400 - for shipment max length cm 300

bianco e nero lunghezza massima profilo cm. 210

white and black max length cm 210

Colori profilo  2 All. anodizzato  5 Bianco  9 Nero  
profile colours anodized al. white black

## PROFILI TAGLIATI A MISURA COMPLETI DI STRIP LED

Il codice del prodotto è riferito a 10 cm. di profilo completo di strip led.

Per definire la lunghezza finale del binario considerare la misura di taglio della strip (14,4w ogni 10cm - 19,2w ogni 2,5cm)

+ 2cm per i tappi di chiusura e il cablaggio.

**Esempio di ordine:** Profilo + 2strip 14,4w/m cm128 (profilo cm128 2strip cm120) Profilo+ 2strip 14,4w/m cm152 (profilo cm152 2strip cm150)

**Composizione codice:** profilo bianco-WW-schermo satinato = 90214-5-6-1 cm....

## TAILORED CUT PROFILES COMPLETED WITH LED STRIP

The code of the product is referred to 10cm of it.

To define the final length of the profile consider the cut measure of the strip (14,4w each 10cm - 19,2w each 2,5cm)

+2cm for the closing tops and the wiring

**Example of order:** profile + 2 led strip 14,4w/m cm128 (profilo cm128 2strip cm120) profile + 2led strip 14,4w/m cm152 (profilo cm152 2strip cm150)

**Code composition:** white profile-WW-satinated screen = 90214-5-6-1 cm ....

Sigma2 led con 2 strip **60 led/m 14,4 w/m Lm/m 2160/2220 24 Vdc**

Durata 30000h Temp. -20+40°C Taglio ogni 10cm

Sigma2 led with 2 strip **60 led/m 14,4w/m Lm/m 2160/2220 24 Vdc**

Lasting 30000h Temp. -20+40°C Cut every 10cm

Colori led  1 Natural white  6 Warm white  9 RGB  
led colours 4000-4500°K 2800-3300°K

**90214 2** 10 cm alluminio - 10 cm anodized alum.

**90214 5** 10 cm bianco - 10 cm white

**90214 9** 10 cm nero - 10 cm black

Sigma2 led con 2 strip **240 led/m 19,2 w/m Lm/m 3080/3160 24 Vdc**

Durata 30000h Temp. -20+40°C Taglio ogni 2,5cm

Sigma2 led with 2 strip **240 led/m 19,2w/m Lm/m 3080/3160 24 Vdc**

Lasting 30000h Temp. -20+40°C Cut every 2,5cm

Colori led  1 Natural white  6 Warm white  
led colours 4000-4500°K 2800-3300°K

**90219 2** 10 cm alluminio - 10 cm anodized alum.

**90219 5** 10 cm bianco - 10 cm white

**90219 9** 10 cm nero - 10 cm black

Schermo - Screen



1 Satinato



2 Curvo satinato

CE IP 40 LED CRI 75-80



## ACCESSORI



**9654**  
Supporto per sospensione H 2000mm  
Suspension kit H 2000mm



**9659**  
Supporto parete/soffitto orientabile  
Wall/ceiling adjustable kit



**9656**  
Supporto parete/soffitto  
Wall/ceiling kit

Utilizzare alimentatore da pag. 204  
Schemi assemblaggio da pag. 214  
Use drivers from page 204  
Assembly schemes from page 214



# OMEGA LED

Design Athena

Profilo in alluminio anodizzato completo di strip LED. Schermo in policarbonato, cavo alimentazione mm 2000

Anodized aluminium profile complete with strip led. Polycarbonate screen, wire length mm 2000



A lunghezza massima profilo cm. 400 - per spedizioni max cm. 300  
 max length cm 400 - for shipment max length cm 300  
 bianco e nero lunghezza massima profilo cm. 210  
 white and black max length cm 210

Colori profilo  2 All. anodizzato  5 Bianco  9 Nero  
 profile colours anodized al. white black

## PROFILI TAGLIATI A MISURA COMPLETI DI STRIP LED

Il codice del prodotto è riferito a 10 cm. di profilo completo di strip led.

Per definire la lunghezza finale del binario considerare la misura di taglio della strip (14,4w ogni 10cm - 19,2w ogni 2,5cm) + 2cm per i tappi di chiusura e il cablaggio.

**Esempio di ordine:** Profilo + strip 14,4w/m cm128 (profilo cm128 strip cm120) Profilo + strip 14,4w/m cm152 (profilo cm152 strip cm150)

**Composizione codice:** profilo-WW-schermo satinato = 9514-6-1 cm....

## TAILORED CUT PROFILES COMPLETED WITH LED STRIP

The code of the product is referred to 10cm of it.

To define the final length of the profile consider the cut measure of the strip (14,4w each 10cm - 19,2w each 2,5cm) +2cm for the closing tops and the wiring

**Example of order:** profile + led strip 14,4w/m cm128 (profile cm128 strip cm120) profile + led strip 14,4w/m cm152 (profile cm152 strip cm150)

**Code composition:** profile-WW-satinated screen = 9514-6-1 cm ....

Omega led con strip **60 led/m 14,4 w/m Lm/m 1080/1110 24 Vdc**

Durata 30000h Temp. -20+40°C Taglio ogni 10cm

Omega led with strip **60 led/m 14,4w/m Lm/m 1080/1110 24 Vdc**

Lasting 30000h Temp. -20+40°C Cut every 10cm

Colori led  1 Natural white  6 Warm white  9 RGB  
 led colours 4000-4500°K 2800-3300°K

9514 2 10 cm alluminio - 10 cm anodized alum.

Omega led con strip **240 led/m 19,2 w/m Lm/m 1540/1580 24 Vdc**

Durata 30000h Temp. -20+40°C Taglio ogni 2,5cm

Omega led with strip **240 led/m 19,2w/m Lm/m 1540/1580 24 Vdc**

Lasting 30000h Temp. -20+40°C Cut every 2,5cm

Colori led  1 Natural white  6 Warm white  
 led colours 4000-4500°K 2800-3300°K

9519 2 10 cm alluminio - 10 cm anodized alum.

Schermo - Screen



1 Satinato



2 Trasparente



3 Lente 40°/Trasparente

CE IP 40 LED CRI 75-80 A F D

## ACCESSORI

Utilizzare alimentatore da pag. 204  
 Schemi assemblaggio da pag. 214  
 Use drivers from page 204  
 Assembly schemes from page 214



9655

Supporto parete/soffitto orientabile  
 Wall/ceiling adjustable kit



9654

Supporto per sospensione H 2000mm  
 Suspension kit H 2000mm



# DELTA LED

Design Athena

Profilo in alluminio anodizzato completo di strip LED. Schermo in policarbonato, cavo alimentazione mm 2000

Anodized aluminium profile complete with strip led. Polycarbonate screen, wire length mm 2000



A lunghezza massima profilo cm. 400 - per spedizioni max cm. 300

max length cm 400 - for shipment max length cm 300

bianco e nero lunghezza massima profilo cm. 210

white and black max length cm 210

Colori profilo  2 All. anodizzato  5 Bianco  9 Nero  
profile colours anodized al. white black

## PROFILI TAGLIATI A MISURA COMPLETI DI STRIP LED

Il codice del prodotto è riferito a 10 cm. di profilo completo di strip led.

Per definire la lunghezza finale del binario considerare la misura di taglio della strip (14,4w ogni 10cm - 19,2w ogni 2,5cm)

+ 2cm per i tappi di chiusura e il cablaggio oppure + 8cm per le versioni Touch e Mov.

**Esempio di ordine:** Profilo Touch + strip 14,4w/m cm128 (profilo cm128 - strip cm120) Profilo Led + strip 14,4w/m cm152 (profilo cm152 strip cm150)

**Composizione codice:** profilo bianco-WW-schermo satinato = 9614-5-6-1 cm....

## TAILORED CUT PROFILES COMPLETED WITH LED STRIP

The code of the product is referred to 10cm of it.

To define the final length of the profile consider the cut measure of the strip (14,4w each 10cm - 19,2w each 2,5cm)

+2cm necessary for the closing tops and the wiring or +8cm for the versions Touch and Mov

**Example of order:** profile Touch + strip 14,4w/m cm128 (profile cm128 - strip cm120) profile Led + strip 14,4w/m of cm152 (profile cm152 - strip cm150)

**Code composition:** white profile - ww -w satin screen = 9614-5-6-1 cm.....

Delta led con strip **60 led/m 14,4 w/m Lm/m 1080/1110 24 Vdc**

Durata 30000h Temp. -20+40°C Taglio ogni 10cm

Delta led with strip **60 led/m 14,4 w/m Lm/m 1080/1110 24 Vdc**

Lasting 30000h Temp. -20+40°C Cut every 10cm

Colori led  1 Natural white  6 Warm white  9 RGB  
led colours 4000-4500°K 2800-3300°K

**9614 2** 10 cm alluminio - 10 cm anodized alum.

**9614 5** 10 cm bianco - 10 cm white

**9614 9** 10 cm nero - 10 cm black

Delta led con strip **240 led/m 19,2 w/m Lm/m 1540/1580 24 Vdc**

Durata 30000h Temp. -20+40°C Taglio ogni 2,5cm

Delta led with strip **240 led/m 19,2 w/m Lm/m 1540/1580 24 Vdc**

Lasting 30000h Temp. -20+40°C Cut every 2,5cm

Colori led  1 Natural white  6 Warm white  
led colours 4000-4500°K 2800-3300°K

**9619 2** 10 cm alluminio - 10 cm anodized alum.

**9619 5** 10 cm bianco - 10 cm white

**9619 9** 10 cm nero - 10 cm black

Schermo - Screen



1 Satinato



2 Trasparente



3 Lente 40°/Trasparente  
(Solo Delta Led - Only Delta LED)

Driver non incluso.

Driver not included

CE IP 40 LED CRI 75-80 A V

## ACCESSORI

Utilizzare alimentatore da pag. 204

Schemi assemblaggio da pag. 214

Use drivers from page 204

Assembly schemes from page 214



**9655**

Supporto parete/soffitto orientabile  
Wall/ceiling adjustable kit



**9654**

Supporto per sospensione H 2000mm  
Suspension kit H 2000mm



**9656**

Supporto parete/soffitto  
Wall/ceiling kit

## DELTA TOUCH

Design Athena

Profilo in alluminio anodizzato completo di strip led. Schermo in policarbonato e interruttore DIMMERABILE Touch (max 45w)  
Aluminium profile complete with strip led. Polycarbonate screen and Dimmable Touch switch (max 45w)



A Lunghezza massima con: strip 14,4 w/m = cm 310 strip 19,2 w/m = cm 225  
Max length Profile:with: strip 14,4 w/m = cm 310 strip 19,2 w/m = cm 225



Delta Touch con strip **60 led/mt 14,4 w/m con Touch 24 Vdc**

Durata: 30000h Temp -20° +40°C Lm/m 1080/1110 Taglio strip ogni 10cm

Delta Touch with strip **60 led/mt 14,4w/m with Touch 24 Vdc**

Lasting: 30000h Temp -20 +40°C Lm/m 1080/1110 Strip cut every 10cm

**96814 2** 10 cm alluminio - 10 cm anodized alum.

**96814 5** 10 cm bianco - 10 cm white

**96814 9** 10 cm nero - 10 cm black

Delta Touch con strip **240 led/mt 19,2w/m con Touch 24 Vdc**

Durata: 30000h Temp -20° +40°C Lm/m 1540/1580 Taglio strip ogni 2,5cm

Delta Touch with strip **240 led/mt 19,2w/m with Touch 24 Vdc**

Lasting: 30000h Temp -20 +40°C Lm/m 1540/1580 Strip cut every 2,5cm

**96819 2** 10 cm alluminio - 10 cm anodized alum.

**96819 5** 10 cm bianco - 10 cm white

**96819 9** 10 cm nero - 10 cm black

## DELTA TOUCH DYNAMIC WHITE

Design Athena

Profilo completo di strip led Dynamic White (cold/warm) Interruttore Touch per cambio colore da cold white a warm white (max 45w)  
Aluminium profile complete with strip led Dynamic White (cold/warm) Touch switch for colour change from cold to warm white (max 45w)

Delta Touch Dynamic con strip **120 led/mt 19,2 w/m con Touch 24 Vdc**

Durata: 30000 h Temp -20° +40°C Lm/m 800/820 Taglio strip ogni 5cm

Delta Touch Dynamic with strip **120 led/mt 19,2w/m with Touch 24 Vdc**

Lasting: 30000h Temp -20 +40°C Lm/m 800/820 Strip cut every 5cm

**96829 2** 10 cm alluminio - 10 cm anodized alum.

**96829 2** 10 cm bianco - 10 cm white

**96829 2** 10 cm nero - 10 cm black

Colori led  0 Dynamic white  
led colours 2700-7000°K

## DELTA MOV

Design Athena

Profilo completo di strip led. Schermo policarbonato.  
Sensore di presenza. (rilevazione max mt3 - 120° - max 140w)  
Aluminium profile complete with strip led. Polycarbonate screen. Presence detector.  
(detection max 3m - 120° - max 140w)



A Lunghezza massima profilo cm400 - per spedizioni max cm300  
Max length cm400 - for shipment max length cm300



Delta Mov con strip **60 led/mt 14,4 w/m 24 Vdc** con sensore di presenza

Durata: 30000 h Temp -20° +40°C Lm/m 1080/1110 Taglio strip ogni 10cm

Delta Mov with strip **60 led/mt 14,4w/m 24 Vdc** with presence detector

Lasting: 30000h Temp -20 +40°C Lm/m 1080/1110 Strip cut every 10cm

**96714 2** 10 cm alluminio - 10 cm anodized alum.

**96714 5** 10 cm bianco - 10 cm white

**96714 9** 10 cm nero - 10 cm black

Delta Mov con strip **240 led/mt 19,2w/m 24 Vdc** con sensore di presenza

Durata: 30000 h Temp -20° +40°C Lm/m 1540/1580 Taglio strip ogni 2,5cm

Delta Mov with strip **240 led/mt 19,2w/m 24 Vdc** with presence detector

Lasting: 30000h Temp -20 +40°C Lm/m 1540/1580 Strip cut every 2,5cm

**96719 2** 10 cm alluminio - 10 cm anodized alum.

**96719 5** 10 cm bianco - 10 cm white

**96719 9** 10 cm nero - 10 cm black





# TAU LED

Design Athena

Profilo in alluminio anodizzato angolare completo di strip LED. Schermo in policarbonato, cavo alimentazione mm 2000  
Anodized aluminium profile complete with strip led. Polycarbonate screen, wire length mm 2000

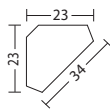
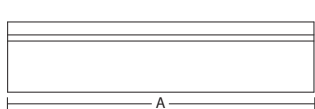

A lunghezza massima profilo cm. 400 - per spedizioni max cm. 300  
max length cm 400 - for shipment max length cm 300  
bianco e nero lunghezza massima profilo cm. 210  
white and black max length cm 210

Colori profilo    2 All. anodizzato    5 Bianco    9 Nero  
profile colours    anodized al.    white    black

## PROFILI TAGLIATI A MISURA COMPLETI DI STRIP LED

Il codice del prodotto è riferito a 10 cm. di profilo completo di strip led.

Per definire la lunghezza finale del binario considerare la misura di taglio della strip (14,4w ogni 10cm - 19,2w ogni 2,5cm) + 2cm per i tappi di chiusura e il cablaggio oppure +8cm per le versioni Touch e Mov

**Esempio di ordine:** Profilo Touch + strip 14,4w/m cm128 (profilo cm128 strip cm120) Profilo Led + strip 14,4w/m cm152 (profilo cm152 strip cm150)

**Composizione codice:** profilo bianco-WW-schermo satinato = 9114-5-6-1 cm....

## TAILORED CUT PROFILES COMPLETED WITH LED STRIP

The code of the product is referred to 10cm of it.

To define the final length of the profile consider the cut measure of the strip (14,4w each 10cm - 19,2w each 2,5cm) +2cm for the closing tops and the wiring or +8cm for the versions Touch and Mov

**Example of order:** profile Touch + led strip 14,4w/m cm128 (profile cm128 strip cm120) profile Led + led strip 14,4w/m cm152 (profile cm152 strip cm150)

**Code composition:** white profile-WW -satinated screen = 9114-5-6-1 cm ....

Tau Led con strip **60 led/m 14,4w/m Lm/m 1080/1110 24 Vdc**

Durata 30000h Temp. -20+40°C Taglio ogni 10cm

Tau Led with strip **60 led/m 14,4w/m Lm/m 1080/1110 24 Vdc**

Lasting 30000h Temp. -20+40°C Cut every 10cm

Colori led    1 Natural white    6 Warm white    9 RGB  
led colours    4000-4500°K    2800-3300°K

**9114 2**    10 cm alluminio - 10 cm anodized alum.

**9114 5**    10 cm bianco - 10 cm white

**9114 9**    10 cm nero - 10 cm black

Tau Led con strip **240 led/m 19,2w/m Lm/m 1540/1580 24 Vdc**

Durata 30000h Temp. -20+40°C Taglio ogni 2,5cm

Tau Led with strip **240 led/m 19,2w/m Lm/m 1540/1580 24 Vdc**

Lasting 30000h Temp. -20+40°C Cut every 2,5cm

Colori led    1 Natural white    6 Warm white  
led colours    4000-4500°K    2800-3300°K

**9119 2**    10 cm alluminio - 10 cm anodized alum.

**9119 5**    10 cm bianco - 10 cm white

**9119 9**    10 cm nero - 10 cm black

Schermo - Screen



1 Satinato



2 Trasparente

Driver non incluso.

Driver not included

CE IP 40 LED CRI 75-80



## ACCESSORI

Utilizzare alimentatore da pag. 204  
Schemi assemblaggio da pag. 214  
Use drivers from page 204  
Assembly schemes from page 214



9656

Supporto parete/soffitto  
Wall/ceiling kit

## TAU TOUCH

Design Athena

Profilo in alluminio anodizzato completo di strip led. Schermo in policarbonato e interruttore DIMMERABILE Touch (max 45w)  
Aluminium profile complete with strip led. Polycarbonate screen and Dimmable Touch switch (max 45w)

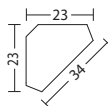
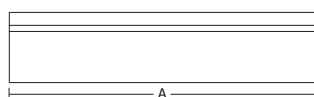

A Lunghezza massima con: strip 14,4 w/m = cm310 strip 19,2 w/m = cm225  
Max length Profile:with: strip 14,4 w/m = cm310 strip 19,2 w/m = cm 225

**Tau Touch con strip 60 led/m 14,4w/m 24 Vdc con Touch**  
Durata: 30000 h Temp -20° +40°C Lm/m 1080/1110 Taglio ogni 10cm  
Tau Touch with strip **60 led/m 14,4w/m 24 Vdc with Touch**  
Lasting: 30000h Temp -20 +40°C Lm/m 1080/1110 Cut every 10cm

**91814 2** 10 cm alluminio - 10 cm anodized alum.  
**91814 5** 10 cm bianco - 10 cm white  
**91814 9** 10 cm nero - 10 cm black

**Tau Touch con strip 240 led/mt 19,2w/m 24 Vdc con Touch**  
Durata: 30000 h Temp -20° +40°C Lm/m 1540/1580 Taglio ogni 2,5cm  
Tau Touch with strip **240 led/m 19,2w/m 24 Vdc with Touch**  
Lasting: 30000h Temp -20 +40°C Lm/m 1540/1580 Cut every 2,5cm

**91819 2** 10 cm alluminio - 10 cm anodized alum.  
**91819 5** 10 cm bianco - 10 cm white  
**91819 9** 10 cm nero - 10 cm black

## TAU TOUCH DYNAMIC WHITE

Design Athena

Profilo completo di strip led.Dynamic White (cold/warm) Interruttore Touch per cambio colore da cold white a warm white (max 45w)  
Profile complete with strip led Dynamic White (cold/warm) Touch switch for colour change from cold to warm white (max 45w)

**Tau Touch Dynamic con strip 120 led/mt 19,2 w/m 24 Vdc con Touch**  
Durata: 30000 h Temperatura -20° +40°C Lm/m 800/820 Taglio strip ogni 5cm  
Tau Touch with strip **120 led/mt 19,2w/m 24 Vdc with Touch**  
Lasting: 30000h Temp. -20 +40°C Lm/m 800/820 Cut every 5cm

**91829 2** 10 cm alluminio - 10 cm anodized alum.  
**91829 5** 10 cm bianco - 10 cm white  
**91829 9** 10 cm nero - 10 cm black

Colori led  0 Dynamic white  
led colours 2700-7000°K

## TAU MOV

Design Athena

Profilo in alluminio anodizzato completo di strip led. Schermo in policarbonato e sensore di presenza (rilevazione max m.3 - 120° - max 140w)

Aluminium profile complete with strip led. Polycarbonate screen and presence detector  
(detection max m.3 - 120° - max 140w)

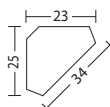
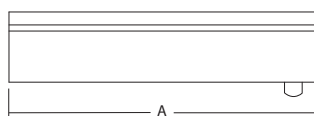

A Lunghezza massima profilo cm400 - per spedizioni max cm300  
Max length cm400 - for shipment max length cm300

**Tau Mov con strip 60 led/mt 14,4 w/m 24 Vdc con sensore di presenza**  
Durata: 30000 h Temp -20° +40°C Lm/m 1080/1110 Taglio ogni 10cm  
Tau Mov with strip **60 led/mt 14,4 w/m 24 Vdc with presence detector**  
Lasting: 30000h Temp. -20 +40°C Lm/m 1080/1110 Cut every 10cm

**91714 2** 10 cm alluminio - 10 cm anodized alum.  
**91714 5** 10 cm bianco - 10 cm white  
**91714 9** 10 cm nero - 10 cm black

**Tau Mov con strip 240 led/mt 19,2 w/m 24 Vdc con sensore di presenza**  
Durata: 30000 h Temp. -20° +40°C Lm/m 1540/1580 Taglio ogni 2,5cm  
Tau Mov with strip **240 led/mt 19,2 w/m 24 Vdc with presence detector**  
Lasting: 30000h Temp. -20 +40°C Lm/m 1540/1580 Cut every 2,5cm

**91719 2** 10 cm alluminio - 10 cm anodized alum.  
**91719 5** 10 cm bianco - 10 cm white  
**91719 9** 10 cm nero - 10 cm black



# SIHON LED

Design Athena

Profilo in alluminio anodizzato completo di strip LED installazione anche ad incasso. Schermo in policarbonato, cavo alimentazione mm 2000

Anodized aluminium profile complete with strip led. Polycarbonate screen, wire length mm 2000

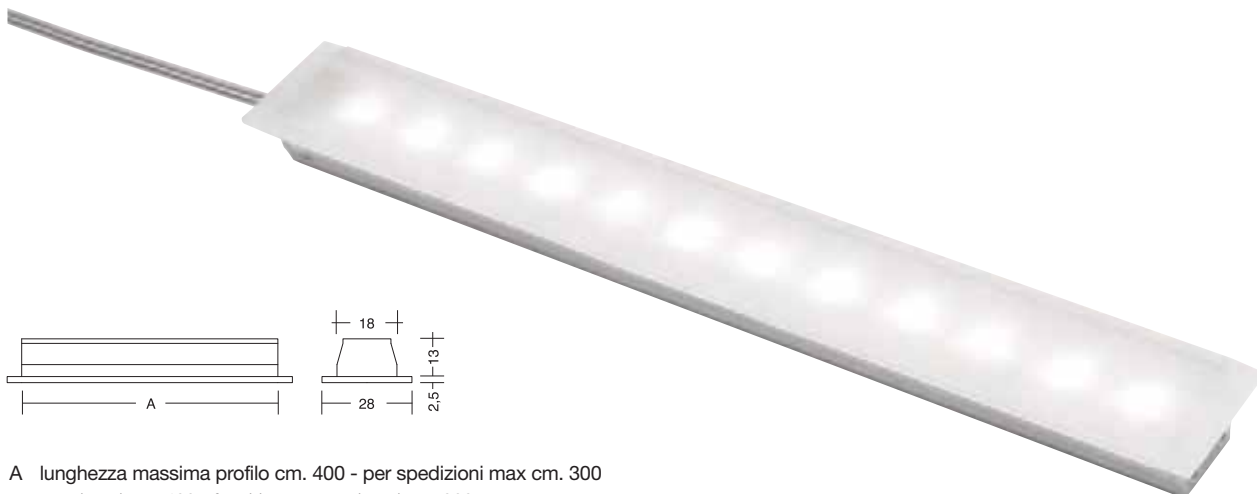

A lunghezza massima profilo cm. 400 - per spedizioni max cm. 300  
max length cm 400 - for shipment max length cm 300

Colori profilo 2 All. anodizzato  
profile colours anodized al.

## PROFILI TAGLIATI A MISURA COMPLETI DI STRIP LED

Il codice del prodotto è riferito a 10 cm. di profilo completo di strip led.

Per definire la lunghezza finale del binario considerare la misura di taglio della strip (14,4w ogni 10cm - 19,2w ogni 2,5cm)

+2cm necessari per i tappi di chiusura e il cablaggio oppure + 8cm per le versioni Touch e Mov.

**Esempio di ordine:** Profilo + strip 14,4w/m cm128 (profilo cm128 strip cm120) Profilo Led + strip 14,4w/m cm152 (profilo cm152 strip cm150)

**Composizione codice:** profilo Touch-WW-schermo satinato = 9314-6-1 cm....

## TAILORED CUT PROFILES COMPLETED WITH LED STRIP

The code of the product is referred to 10cm of it.

To define the final length of the profile consider the cut measure of the strip (14,4w each 10cm - 19,2w each 2,5cm)

+2cm for the closing tops and the wiring or + 8cm for the version Touch or Mov.

**Example of order profile:** + led strip 14,4w/m cm128 (profile cm128 strip cm120) profile Led with led strip 14,4w/m cm152 (profile cm152 strip cm150)

**Code composition:** profile Touch-WW-satinated screen = 9314-6-1 cm ....

Sihon led con strip **60 led/m 14,4 w/m Lm/m 1080/1110 24 Vdc**

Durata 30000h Temp. -20+40°C Taglio ogni 10cm

Sihon led with strip **60 led/m 14,4w/m Lm/m 1080/1110 24 Vdc**

Lasting 30000h Temp. -20+40°C Cut every 10cm

Colori led 1 Natural white 6 Warm white 9 RGB  
led colours 4000-4500°K 2800-3300°K

**9314 2** 10 cm alluminio - 10 cm anodized alum.

Sihon led con strip **240 led/m 19,2w/m Lm/m 1540/1580 24 Vdc**

Durata 30000h Temp. -20+40°C Taglio ogni 2,5cm

Sihon led with strip **240 led/m 19,2w/m Lm/m 1540/1580 24 Vdc**

Lasting 30000h Temp. -20+40°C Cut every 2,5cm

Colori led 1 Natural white 6 Warm white  
led colours 4000-4500°K 2800-3300°K

**9319 2** 10 cm alluminio - 10 cm anodized alum.

CE IP 40 LED CRI 75-80 A F III

## ACCESSORI

Utilizzare alimentatori da pag. 204 - Schemi assemblaggio da pag. 214  
Use drivers from page 204 - Assembly schemes from page 214

Driver non incluso.  
Driver not included

## SIHON TOUCH

Design Athena

Profilo in alluminio anodizzato completo di strip led. Schermo in policarbonato e interruttore DIMMERABILE Touch (max 45w)

Aluminium profile complete with strip led. Polycarbonate screen and Dimmable Touch switch (max 45w)

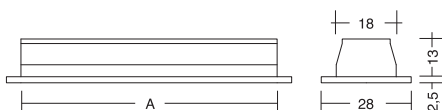

A Lunghezza massima con: strip 14,4 w/m = cm 310 strip 19,2 w/m = cm 225  
Max length Profile: with: strip 14,4 w/m = cm 310 strip 19,2 w/m = cm 225

Sihton Touch con strip **60 led/mt 14,4 w/m 24 Vdc** con Touch  
Durata: 30000h Temp -20° +40°C Lm/m 1080/1110 Taglio strip ogni 10cm  
Sihton Touch with strip **60 led/mt 14,4w/m 24 Vdc** with Touch  
Lasting: 30000h Temp -20 +40°C Lm/m 1080/1110 Strip cut every 10cm

**93814 2** 10 cm alluminio - 10 cm anodized alum.

Sihton Touch con strip **240 led/mt 19,2w/m 24 Vdc** con Touch  
Durata: 30000h Temp -20° +40°C Lm/m 1540/1580 Taglio strip ogni 2,5cm  
Sihton Touch with strip **240 led/mt 19,2w/m 24 Vdc** with Touch  
Lasting: 30000h Temp -20 +40°C Lm/m 1540/1580 Strip cut every 2,5cm

**93819 2** 10 cm alluminio - 10 cm anodized alum.

## SIHON TOUCH DYNAMIC WHITE

Design Athena

Profilo completo di strip led Dynamic White (cold/warm) Interruttore Touch per cambio colore da cold white a warm white (max 45w)

Aluminium profile complete with strip led Dynamic White (cold/warm) Touch switch for colour change from cold to warm white (max 45w)

Sihton Touch Dynamic con strip **120 led/mt 19,2 w/m 24 Vdc** con Touch  
Durata: 30000 h Temp -20° +40°C Lm/m 800/820 Taglio strip ogni 5cm  
Sihton Touch Dynamic with strip **120 led/mt 19,2w/m 24 Vdc** with Touch  
Lasting: 30000h Temp -20 +40°C Lm/m 800/820 Strip cut every 5cm

**93829 2** 10 cm alluminio - 10 cm anodized alum.

Colori led  0 Dynamic white  
led colours 2700-7000°K

## SIHON MOV

Design Athena

Profilo in alluminio anodizzato completo di strip led. Schermo in policarbonato e sensore di presenza (rilevazione max m.3 - 120° - max 140w)

Aluminium profile complete with strip led. Polycarbonate screen and presence detector (detection max m.3 - 120° - 140w)

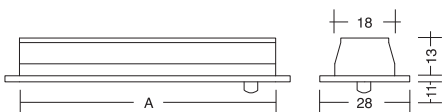

A Lunghezza massima profilo cm400 - per spedizioni max cm300  
Max length cm400-for shipment max length cm300

Sihton Mov con strip **60 led/mt 14,4 w/m 24 Vdc** con sensore di presenza  
Durata: 30000 h Temp -20° +40°C Lm/m 1080/1110 Taglio strip ogni 10cm  
Sihton Mov with strip **60 led/mt 14,4w/m 24 Vdc** with presence detector  
Lasting: 30000h Temp -20 +40°C Lm/m 1080/1110 Strip cut every 10cm

**93714 2** 10 cm alluminio - 10 cm anodized alum.

Sihton Mov con strip **240 led/mt 19,2w/m 24 Vdc** con sensore di presenza  
Durata: 30000 h Temp -20° +40°C Lm/m 1540/1580 Taglio strip ogni 2,5cm  
Sihton Mov with strip **240 led/mt 19,2w/m 24 Vdc** with presence detector  
Lasting: 30000h Temp -20 +40°C Lm/m 1540/1580 Strip cut every 2,5cm

**93719 2** 10 cm alluminio - 10 cm anodized alum.

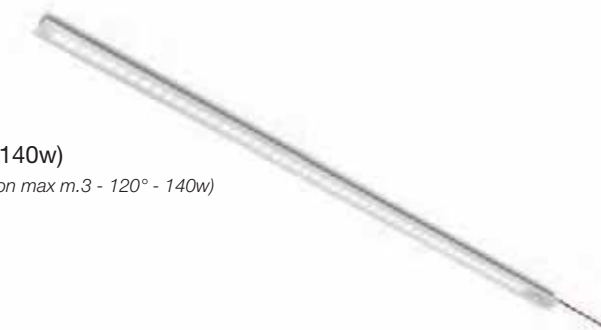



## ACCESSORI



**930599**

Controcassa per incasso  
murature e laterizio. mm 60 x 30  
*Casing for brickwork*

Il codice si riferisce a 10 cm di controcassa  
*Code number refer to 10 cm of casing*

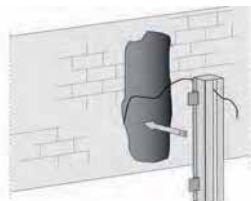

mm 150 x 150



**930549**

Controcassa curva orizzontale  
per incasso murature e laterizio.  
*Horizontal corner casing  
for brickwork.*



mm 150 x 150



**930550**

Controcassa curva verticale  
per incasso murature e laterizio.  
*Vertical corner casing for  
brickwork.*

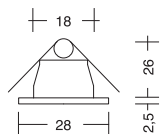

**9353**

Molla per incasso controsoffitto  
e controcassa

*Spring for recessed ceiling*

Foro incasso larghezza 19 mm

*Recessed hole width 19 mm*

Da posizionare a inizio e fine binario  
più 1 ogni 50 cm

*Place: beginning - end and every 50 cm*



**9654**

Supporto per sospensione  
H 2000mm

*Suspension kit H 2000mm*

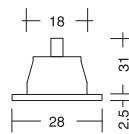

**9655**

Supporto parete/soffitto orientabile

*Wall/ceiling adjustable kit*

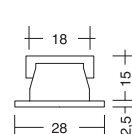

**9656**

Supporto parete/soffitto

*Wall/ceiling kit*



# ETHA

Design Athena

Profilo CALPESTABILE in alluminio anodizzato. Schermo in policarbonato completo di strip LED e cavo alimentazione mm2000  
WALKABLE anodized aluminium profile. Polycarbonate screen complete with strip led and wire length mm2000



Cassaforma senza bordo  
Anodized aluminium profile

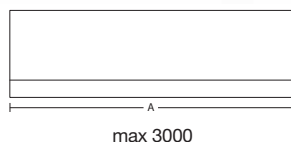

**9298 2** 10cm alluminio - 10cm anodized alum.

Cassaforma con bordo  
Anodized aluminium profile

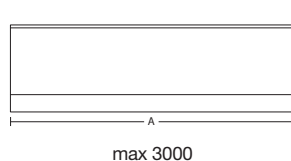

**9299 2** 10cm alluminio - 10cm anodized alum.

Policarbonato con strip led  
Polycarbonate with strip led

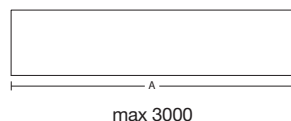

Il codice si riferisce a 10 cm di profilo  
Code number refer to 10 cm of profile

## POLICARBONATO TAGLIATO A MISURA COMPLETO DI STRIP LED e cavo Fror 2x0,50 cm200

Il codice del prodotto è riferito a 10 cm. di profilo completo di strip led.

Per definire la lunghezza finale del binario considerare multipli da 10cm per strip 4,8w e multipli da 5cm per strip 9,6w + 4cm per i tappi di chiusura e il cablaggio.

**Esempio di ordine:** policarbonato + strip 4,8w/m cm124 (policarbonato cm124 strip cm120) profilo+ strip 9,6w/m cm147 (profilo cm147 strip cm140)

**Composizione codice:** policarbonato bianco-WW= 9205-6 cm....

### TAILORED CUT PROFILES COMPLETED WITH LED STRIP

The code of the product is referred to 10cm of it.

To define the final length of the profile consider multiples of 10cm for strip 4,8w and multiples of 5cm for strip 9,6w +4cm for the closing tops and the wiring

**Example of order:** polycarbonate + strip 4,8w/m cm124 (profile cm124 strip cm120) polycarbonate+strip 9,6w/m cm147 (profile cm147 strip cm140)

**Code composition:** white polycarbonate-WW = 9205-6 cm ....

Policarbonato con strip **60 led/mt 4,8 w/mt 24 Vdc** + Cavo Fror 2x0,50 cm200

Durata 30000h Temp. -20 +40°C Lm/m 360/400

Polycarbonate with strip led **60 led/mt 24 Vdc** + Fror cable 2x0,50 cm200

Last 30000h Temp. -20 +40°C Lm/m 360/400

**9205** 10cm policarbonato - 10cm polycarbonate.

Policarbonato con strip **120 led/mt 9,6 w/mt 24 Vdc** + Cavo Fror 2x0,50 cm200

Durata 30000h Temp. -20 +40°C Lm/m 780/800

Polycarbonate with strip led **120 led/mt 24 Vdc** + Fror cable 2x0,50 cm200

Last 30000h Temp. -20 +40°C Lm/m 780/800

**9210** 10cm policarbonato - 10cm polycarbonate.

Colori led  
led colours

■ 1 Natural white  
4000-4500°K

■ 6 Warm white  
2800-3300°K

CE IP 67 LED CRI 75-80     

## ACCESSORI

Utilizzare alimentatori da pag. 204 - Schemi assemblaggio da pag. 214  
Use drivers from page 204 - Assembly schemes from page 214

Driver non incluso.  
Driver not included



# OMEGA WET

Design Athena

Profilo in alluminio anodizzato completo di strip led e inserito in tubo trasparente idoneo per IP67. Schermo in policarbonato. Completo di attacco parete/soffitto, tappo di chiusura e cavo di alimentazione Fror cm 200 o doppio cavo alimentazione Fror cm 20 + cm 200.

Anodized aluminium profile complete with strip, inserted in an IP67 clear tube. Polycarbonate screen. Complete with wall/ceiling connection, closure plug and 200 cm power supply cable.



## PROFILI TAGLIATI A MISURA INSERITI IN TUBO TRASPARENTE E COMPLETI DI STRIP LED

Il codice del prodotto è riferito a 10 cm. di profilo inserito in tubo trasparente e completo di strip led.

Per definire la lunghezza finale del binario considerare la misura di taglio della strip (4,8w e 14,4w ogni 10cm - 9,6w ogni 5cm) + 8cm per i tappi di chiusura e il cablaggio.

**Esempio di ordine:** Profilo+ strip 14,4w/m cm128 (profilo cm128 - strip cm120) Profilo+ strip 14,4w/m cm152 (profilo cm152 strip cm140)

**Composizione codice:** profilo-WW = 95514-6 cm....

## TAILORED CUT PROFILES INSERT IN A CLEAR TUBE AND COMPLETED WITH LED STRIP

The code of the product is referred to 10cm of it.

To define the final length of the profile consider the cut measure of the strip (4,8 and 14,4w each 10cm - 9,6w each 5cm) +8cm for the closing tops and the wiring

**Example of order:** profile + led strip 14,4w/m cm128 (profile cm128 strip cm120) profile with led strip 14,4w/m cm152 (profile cm152 strip cm140)

**Composizione codice:** profile-WW = 95514-6 cm....

## CAVO ALIMENTAZIONE FROR cm 200+TAPPO

Omega Wet IP67 con strip **60 led/m 4,8w/m 24 Vdc** lm/m 360/400

Durata 30000h Temp. -20+40°C Taglio ogni 10cm

Omega Wet IP67 with led strip **60 led/m 4,8w/m 24 Vdc** lm/m 360/400

Lasting 30000h Temp -20+40°C Strip cut every 10cm

**95505 2** 10cm alluminio - 10cm anodized alum.

Omega Wet IP67 con strip **120 led/m 9,6w/m 24 Vdc** lm/m 780/800

Durata 30000h Temp. -20+40°C Taglio ogni 5cm

Omega Wet IP67 with led strip **120 led/m 9,6w/m 24 Vdc** lm/m 780/800

Lasting 30000h Temp -20+40°C Strip cut every 5cm

**95510 2** 10cm alluminio - 10cm anodized alum.

Omega Wet IP67 con strip **60 led/m 14,4w/m 24 Vdc** lm/m 1080/1110

Durata 30000h Temp. -20+40°C Taglio ogni 10cm

Omega Wet IP67 with led strip **60 led/m 14,4w/m 24 Vdc** lm/m 1080/1110

Lasting 30000h Temp -20+40°C Strip cut every 10cm

**95514 2** 10cm alluminio - 10cm anodized alum.

# OMEGA WET

Design Athena



## DOPPIO CAVO ALIMENTAZIONE FROR cm 20+ cm 200

Omega Wet IP67 con strip **60 led/m 4,8w/m 24 Vdc** lm/m 360/400  
Durata 30000h Temp. -20+40°C Taglio ogni 10cm

Omega Wet IP67 with led strip **60 led/m 4,8w/m 24 Vdc** lm/m 360/400  
Lasting 30000h Temp -20+40°C Strip cut every 10cm

**95605 2** 10cm alluminio - 10cm anodized alum.

Omega Wet IP67 con strip **120 led/m 9,6 w/m 24 Vdc** lm/m 780/800  
Durata 30000h Temp. -20+40°C Taglio ogni 5cm

Omega Wet IP67 with led strip **120 led/m 9,6w/m 24 Vdc** lm/m 780/800  
Lasting 30000h Temp -20+40°C Strip cut every 5cm

**95610 2** 10cm alluminio - 10cm anodized alum.

Omega Wet IP67 con strip **60 led/m 14,4w/m 24 Vdc** lm/m 1080/1110  
Durata 30000h Temp. -20+40°C Taglio ogni 10cm

Omega Wet IP67 with led strip **60 led/m 14,4w/m 24 Vdc** lm/m 1080/1110  
Lasting 30000h Temp -20+40°C Strip cut every 10cm

**95614 2** 10cm alluminio - 10cm anodized alum.

Colori led led colours

■ 1 Natural white	■ 6 Warm white
4000-4500°K	2800-3300°K

Schermo - Screen



1 Satinato



2 Trasparente

CE IP 67 LED CRI 75-80 A V

## ACCESSORI

Utilizzare alimentatori da pag. 204 - Schemi assemblaggio da pag. 214  
Use drivers from page 204 - Assembly schemes from page 214

Driver non incluso.  
Driver not included





# SIGMA

Design Athena

## Profilo in alluminio anodizzato con schermo in policarbonato

Anodized aluminium profile complete with polycarbonate screen

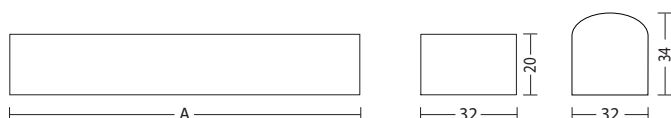

A lunghezza massima profilo cm. 400 - per spedizioni max cm. 300  
 max length cm 400 - for shipment max length cm 300  
 bianco e nero lunghezza massima profilo cm. 210  
 white and black max length cm 210

Colori profilo profile colours  
 ■ 2 All. anodizzato anodized al. □ 5 Bianco white ■ 9 Nero black



9099 2 10 cm alluminio - 10 cm anodized alum.  
 9099 5 10 cm bianco - 10 cm white  
 9099 9 10 cm nero - 10 cm black

Il codice del prodotto è riferito a 10cm di profilo.  
 In fase d'ordine precisare la misura del profilo richiesta  
 Code number refer to 10cm profile.  
 Ordering, specify the length of the profile request

	<b>9047</b> Tappo con foro per schermo curvo Dead-end for curved screen		<b>7</b>		<b>9653</b> Elemento di congiunzione meccanico Straight mechanical connector		<b>0,80</b>
	<b>9048</b> Tappo senza foro per schermo curvo Dead-end for curved screen		<b>8</b>		<b>9654</b> Supporto per sospensione H 2000 mm Suspension kit H 2000 mm		<b>155</b>
	<b>9049</b> Angolo 90° verticale Vertical 90° corner		<b>180</b>		<b>9659</b> Supporto parete/soffitto orientabile Wall/ceiling adjustable kit		<b>68</b>
	<b>9050</b> Angolo 90° orizzontale Horizontal 90° corner		<b>180</b>		<b>9656</b> Supporto parete/soffitto Wall/ceiling kit		<b>1,50</b>
	<b>9051</b> Tappo senza foro per schermo piatto Dead-end for flat screen		<b>2</b>		<b>9657</b> Elemento di congiunzione meccanico per angolo 90° orizzontale Mechanical connector for horizontal corner 90°		<b>0,80</b>
	<b>9052</b> Tappo con foro per schermo piatto Holed end for flat screen		<b>2</b>		<b>9658</b> Elemento di congiunzione meccanico per angolo 90° verticale Mechanical connector for vertical corner 90°		<b>0,80</b>
	<b>9660</b> Lavorazione taglio ad angolo 45° dei profili 45° cutting of the profiles						

Schermo - Screen



1 Satinato



2 Curvo satinato

# SIGMA3

Design Athena

Profilo in alluminio anodizzato con schermo in policarbonato completo di accessori per installazione a scomparsa per soffitti e pareti in cartongesso

Anodized aluminium profile with polycarbonate screen and accessories for recessed mounting

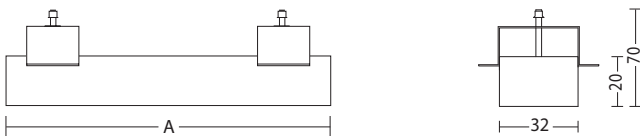

A Lunghezza massima profilo cm.400 - per spedizioni max cm.300  
Max length cm 400 - for shipment max cm 300

**90399 2** 10 cm alluminio - 10 cm anodized alum.

Il codice del prodotto è riferito a 10cm di profilo.  
In fase d'ordine precisare la misura del profilo richiesta  
Code number refer to 10cm profile.  
Ordering, specify the length of the profile request



**9049** Angolo 90°  
verticale  
Vertical  
90° corner



**9051** Tappo senza foro  
Dead-end



**9052** Tappo con foro  
Holed end



**9050** Angolo 90°  
orizzontale  
Horizontal  
90° corner



**9653** Elemento di congiunzione meccanico  
Straight mechanical connector



**9657** Elemento di congiunzione meccanico  
per angolo 90° orizzontale  
Mechanical connector for horizontal  
corner 90°



**9658** Elemento di congiunzione meccanico  
per angolo 90° verticale  
Mechanical connector for vertical  
corner 90°



**9660** Lavorazione taglio  
ad angolo 45° dei profili  
45° cutting of the profiles

Schema installazione  
Mounting scheme

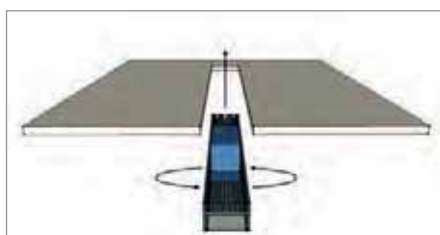



# OMEGA

Design Athena

Profilo in alluminio anodizzato con schermo in policarbonato

Anodized aluminium profile complete with polycarbonate screen



max 3000

A lunghezza massima profilo cm. 400 - per spedizioni max cm. 300

max length cm 400 - for shipment max length cm 300

bianco e nero lunghezza massima profilo cm. 210

white and black max length cm 210

Colori profilo  
profile colours

■ 2 All. anodizzato anodized al. □ 5 Bianco white ■ 9 Nero black



**9549** Angolo 90°  
verticale  
Vertical  
90° corner



**9599 2** 10 cm alluminio - 10 cm anodized alum.  
**9653** Elemento di congiunzione meccanico  
Straight mechanical connector



**9550** Angolo 90°  
orizzontale  
Horizontal  
90° corner



**9654** Supporto per sospensione H 2000 mm  
Suspension kit H 2000 mm



**9551** Tappo senza foro  
Dead-end



**9655** Supporto parete/soffitto orientabile  
Wall/ceiling adjustable kit



**9552** Tappo con foro  
Holed end



**9657** Elemento di congiunzione meccanico  
per angolo 90° orizzontale  
Mechanical connector for horizontal  
corner 90°



**9658** Elemento di congiunzione meccanico  
per angolo 90° verticale  
Mechanical connector for vertical  
corner 90°



**9660** Lavorazione taglio  
ad angolo 45° dei profili  
45° cutting of the profiles

Schermo - Screen



1 Satinato



2 Trasparente



3 Lente 40°/Trasparente

# DELTA

Design Athena

## Profilo in alluminio anodizzato con schermo in policarbonato

Anodized aluminium profile complete with polycarbonate screen



A lunghezza massima profilo cm. 400 - per spedizioni max cm. 300  
 max length cm 400 - for shipment max length cm 300  
 bianco e nero lunghezza massima profilo cm. 210  
 white and black max length cm 210

Colori profilo profile colours  
 ■ 2 All. anodizzato anodized al. □ 5 Bianco white ■ 9 Nero black



**9649** Angolo 90°  
 verticale  
 Vertical  
 90° corner



**9653** Elemento di congiunzione meccanico  
 Straight mechanical connector



**9650** Angolo 90°  
 orizzontale  
 Horizontal  
 90° corner



**9654** Supporto per sospensione H 2000 mm  
 Suspension kit H 2000 mm



**9651** Tappo senza foro  
 Dead-end

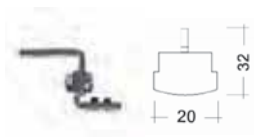

**9655** Supporto parete/soffitto orientabile  
 Wall/ceiling adjustable kit



**9652** Tappo con foro  
 Holed end



**9656** Supporto parete/soffitto  
 Wall/ceiling kit



**9657** Elemento di congiunzione meccanico  
 per angolo 90° orizzontale  
 Mechanical connector for horizontal  
 corner 90°



**9658** Elemento di congiunzione meccanico  
 per angolo 90° verticale  
 Mechanical connector for vertical  
 corner 90°



**9660** Lavorazione taglio  
 ad angolo 45° dei profili  
 45° cutting of the profiles

### Schermo - Screen



1 Satinato



2 Trasparente



3 Lente 40°/Trasparente

**9699 2** 10 cm alluminio - 10 cm anodized alum.  
**9699 5** 10 cm bianco - 10 cm white  
**9699 9** 10 cm nero - 10 cm black

Il codice del prodotto è riferito a 10cm di profilo.  
 In fase d'ordine precisare la misura del profilo richiesta  
 Code number refer to 10cm profile.  
 Ordering, specify the length of the profile request

# TAU

Design Athena

## Profilo angolare in alluminio anodizzato con schermo in policarbonato

Anodized aluminium profile with polycarbonate screen

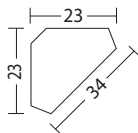
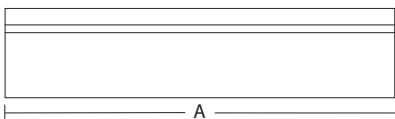

**9199 2** 10 cm alluminio - 10 cm anodized alum.

**9199 5** 10 cm bianco - 10 cm white

**9199 9** 10 cm nero - 10 cm black

**A** lunghezza massima profilo cm. 400 - per spedizioni max cm. 300  
*max length cm 400 - for shipment max length cm 300*  
 bianco e nero lunghezza massima profilo cm. 210  
*white and black max length cm 210*

Il codice del prodotto è riferito a 10cm di profilo.  
 In fase d'ordine precisare la misura del profilo richiesta  
*Code number refer to 10cm profile.*  
*Ordering, specify the length of the profile request*

Colori profilo **2** All. anodizzato **5** Bianco **9** Nero  
*profile colours anodized al. white black*



**9660** Lavorazione taglio ad angolo 45° dei profili  
*45° cutting of the profiles*



**9151** Tappo senza foro  
*Dead-end*



**9653** Elemento di congiunzione meccanico  
*Straight mechanical connector*



**9152** Tappo con foro  
*Holed end*



**9656** Supporto parete/soffitto  
*Wall/ceiling kit*



Schermo - Screen



1 Satinato



2 Trasparente





# KAPPA

Design Athena

Profilo in alluminio anodizzato con schermo in policarbonato

Anodized aluminium profile complete with polycarbonate screen

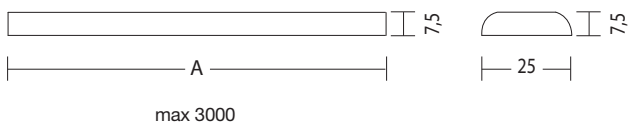

**9499 2** 10 cm alluminio - 10 cm anodized alum.

Il codice del prodotto è riferito a 10cm di profilo.  
In fase d'ordine precisare la misura del profilo richiesta  
Code number refer to 10cm profile.  
Ordering, specify the length of the profile request



**9451** Tappo senza foro  
Dead-end



**9452** Tappo con foro  
Holed end



**9660** Lavorazione taglio  
ad angolo 45° dei profili  
45° cutting of the profiles

## Applicazione con adesivo o con viti forando e svasando il profilo

Application by adhesive or by screws piercing the profile

Schermo - Screen



1 Satinato



2 Trasparente



3 Lente 40°/Trasparente

# PIATTO

Design Athena

Piatto alluminio per dissipazione del calore

Aluminium bar for heat dissipation



- A Lunghezza massima profilo cm.600 - per spedizioni max cm.300 - altezza profilo mm.3  
 Max length cm 600 - for shipment max cm 300 -profile H mm 3



- A Lunghezza massima profilo cm.600 - per spedizioni max cm.300 - altezza profilo mm.2  
 Max length cm 600 - for shipment max cm 300 -profile H mm 2

**9491** 10 cm alluminio - 10 cm anodized alum.

Il codice del prodotto è riferito a 10cm di profilo.  
 In fase d'ordine precisare la misura del profilo richiesta  
 Code number refer to 10cm profile.  
 Ordering, specify the length of the profile request

**9492** 10 cm alluminio - 10 cm anodized alum.

Utilizzare solo con strip 4,8 e 9,6 w/mt  
 Use only with 4,8 and 9,6 w/m strip

Il codice del prodotto è riferito a 10cm di profilo.  
 In fase d'ordine precisare la misura del profilo richiesta  
 Code number refer to 10cm profile.  
 Ordering, specify the length of the profile request



# SIHON

Design Athena

Profilo in alluminio anodizzato con schermo in policarbonato satinato, installazione anche ad incasso

Anodized aluminium recessed profile complete with satined polycarbonate screen

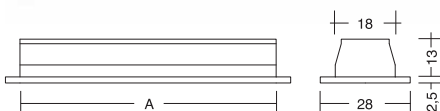

A Lunghezza massima profilo cm.400 - per spedizioni max cm.300  
Max length cm 400 - for shipment max cm 300

**9399 2** 10 cm alluminio - 10 cm anodized alum.

Il codice del prodotto è riferito a 10cm di profilo.  
In fase d'ordine precisare la misura del profilo richiesta  
Code number refer to 10cm profile.  
Ordering, specify the length of the profile request



**9349** Angolo 90° verticale  
Vertical 90° corner



**9353** Molla per incasso controsoffitto e controcassa

Spring for recessed ceiling  
Foro incasso larghezza 19 mm  
Recessed hole width 19 mm  
Da posizionare a inizio e fine binario  
più 1 ogni 50 cm  
Place: beginning - end and every 50 cm



**9350** Angolo 90° orizzontale  
Horizontal 90° corner



**930599** Controcassa per incasso murature e laterizio. mm 60x 30  
Casing for brickwork

Il codice del prodotto è riferito a 10cm di controcassa  
Code number refer to 10cm of casing



**9352** Tappo con foro  
Holed end



**9655** Supporto parete/soffitto orientabile  
Wall/ceiling adjustable kit

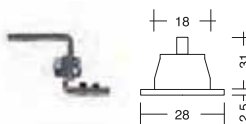

**9654** Supporto per sospensione H 2000 mm  
Suspension kit H 2000 mm



**9653** Elemento di congiunzione meccanico  
Straight mechanical connector

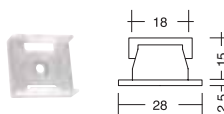

**9656** Supporto parete/soffitto  
Wall/ceiling kit



**930549** Controcassa curva orizzontale per incasso murature e laterizio.  
Horizontal corner casing for brickwork.



**930550** Controcassa curva verticale per incasso murature e laterizio.  
Vertical corner casing for brickwork.



**9657** Elemento di congiunzione meccanico per angolo 90° orizzontale  
Mechanical connector for horizontal corner 90°



**9660** Lavorazione taglio ad angolo 45° dei profili  
45° cutting of the profiles



**9658** Elemento di congiunzione meccanico per angolo 90° verticale  
Mechanical connector for vertical corner 90°





Realizzazione effettuata da La Luce di Alberio - Rovello P.

# STRIP FLEX 19,2 W/MT

Design Athena

Strip led flessibile con biadesivo 3M

Flexible led strip with glue 3M

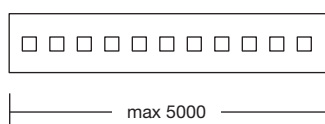

10



CE IP 20

LED CRI 75-80 **A**

## CODICE ROLLA

97601	■ 1 Natural white	Lm/m 1580 4000-4500°K
97606	■ 6 Warm white	Lm/m 1540 2800-3300°K

## CODICE 10 CM STRIP

97691	■ 1 Natural white	Lm/m 1580 4000-4500°K
97696	■ 6 Warm white	Lm/m 1540 2800-3300°K

LED/MT 240  
Potenza 19,2 W/MT  
Volts 24 Vdc  
Durata 30000h  
Separabile ogni 6 led 2,5 cm  
Temperatura -20° +40°C  
Lunghezza max mm 5000  
Corrente diretta 0,8 A/MT  
Cavo aliment. Rosso/nero cm 30

Led/mt 240  
Wattage 19,2 w/mt 0,8A/mt  
Voltage 24Vdc  
Lasting 30000 h  
Cutttable every 6 led 2,5 cm  
Working temperature -20° +40°C  
Max length mm 5000  
Cable red/black cm 30

Installare su superfici dissipanti il calore.  
Applicazione in luoghi asciutti in ambienti interni  
Install only on dissipating surfaces.  
Application in a dry place indoors

Il codice del prodotto è riferito a 10cm di strip  
In fase d'ordine precisare la misura in cm. della strip  
tenendo presente la misura di taglio della stessa.  
Code number refer to 10cm of the strip.  
Ordering, specify the cm. length of the strip considering  
the cutting measure of it



## ACCESSORI

Utilizzare profili da pag. 33 - Alimentatori da pag. 204 - Schemi assemblaggio da pag. 214  
Use profiles from page 33 - Drivers from page 204 - Assembly schemes from page 214

# STRIP FLEX RGB+WHITE

Design Athena

Strip led flessibile con biadesivo 3M

Flexible led strip with glue 3M

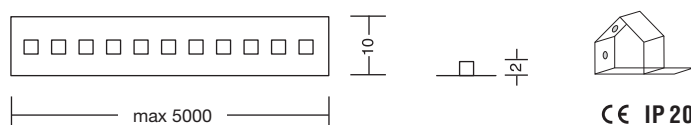

CE IP 20

LED CRI 75-80 **A**

## CODICE ROLLA

97803  3 RGB/White Bianco/White = 2800-3300°K

## CODICE 10 CM STRIP

97893  3 RGB/White Bianco/White = 2800-3300°K

LED/MT 60  
Potenza 19,2 W/MT  
Volts 24 Vdc  
Durata 30000h  
Separabile ogni 6 led 5 cm  
Temperatura -20° +40°C  
Lunghezza max mm 5000  
Corrente diretta 0,8 A/MT  
Cavo aliment. Rosso/nero cm 30

Led/mt 60  
Wattage 19,2 w/mt 0,8A/mt  
Voltage 24Vdc  
Lasting 30000 h  
Cuttable every 6 led 5 cm  
Working temperature -20° +40°C  
Max length mm 5000  
Cable red/black cm 30

Installare su superfici dissipanti il calore.  
Applicazione in luoghi asciutti in ambienti interni  
Install only on dissipating surfaces.  
Application in a dry place indoors

Il codice del prodotto è riferito a 10cm di strip  
In fase d'ordine precisare la misura in cm. della strip  
tenendo presente la misura di taglio della stessa.  
Code number refer to 10cm of the strip.  
Ordering, specify the cm. length of the strip considering  
the cutting measure of it

# STRIP FLEX DYNAMIC WHITE

Design Athena

Regolazione colore da bianco freddo a bianco caldo

Strip colour from cold to warm white

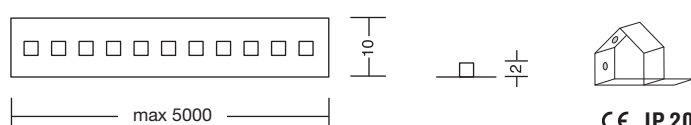

CE IP 20

LED CRI 75-80 **A**

## CODICE ROLLA

97900  0 cold/warm white Lm/m 800 - 2700-7000°K

## CODICE 10 CM STRIP

97990  0 cold/warm white Lm/m 800 - 2700-7000°K

LED/MT 120  
Potenza 19,2 W/MT  
Volts 24 Vdc  
Durata 30000h  
Separabile ogni 6 led 5 cm  
Temperatura -20° +40°C  
Lunghezza max mm 5000  
Corrente diretta 0,8 A/MT  
Cavo aliment. Rosso/nero cm 30

Led/mt 120  
Wattage 19,2 w/mt 0,8A/mt  
Voltage 24Vdc  
Lasting 30000 h  
Cuttable every 6 led 5 cm  
Working temperature -20° +40°C  
Max length mm 5000  
Cable red/black cm 30

Installare su superfici dissipanti il calore.  
Applicazione in luoghi asciutti in ambienti interni  
Install only on dissipating surfaces.  
Application in a dry place indoors

Il codice del prodotto è riferito a 10cm di strip  
In fase d'ordine precisare la misura in cm. della strip  
tenendo presente la misura di taglio della stessa.  
Code number refer to 10cm of the strip.  
Ordering, specify the cm. length of the strip considering  
the cutting measure of it

# STRIP FLEX 14,4 W/MT

Design Athena

Strip led flessibile con biadesivo 3M

Flexible led strip with glue 3M



LED/MT 60  
Potenza 14,4 W/MT  
Volts 24 Vdc  
Durata 30000h  
Separabile ogni 6 led 10 cm  
Temperatura -20° +40°C  
Lunghezza max mm 5000  
Corrente diretta 0,6 A/MT  
Cavo aliment. Rosso/nero cm 30

Led/mt 60  
Wattage 14,4 w/mt 0,6A/mt  
Voltage 24Vdc  
Lasting 30000 h  
Cutttable every 6 led 10cm  
Working temperature -20° +40°C  
Max length mm 5000  
Cable red/black cm 30

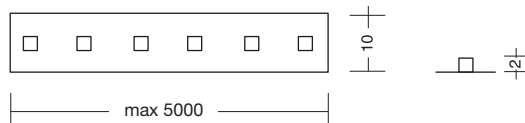

CE IP 20  
LED CRI 75-80 A

Installare su superfici dissipanti il calore.  
Applicazione in luoghi asciutti in ambienti interni  
Install only on dissipating surfaces.  
Application in a dry place indoors

## CODICE ROLLA

99101	1 Natural white	Lm/m 1110 - 4000-4500°K
99106	6 Warm white	Lm/m 1080 - 2800-3300°K
99109	9 RGB	

## CODICE 10 CM STRIP

99191	1 Natural white	Lm/m 1110 - 4000-4500°K
99196	6 Warm white	Lm/m 1080 - 2800-3300°K
99199	9 RGB	

Il codice del prodotto è riferito a 10cm di strip  
In fase d'ordine precisare la misura in cm. della strip  
tenendo presente la misura di taglio della stessa.  
Code number refer to 10cm of the strip.  
Ordering, specify the cm. length of the strip considering  
the cutting measure of it

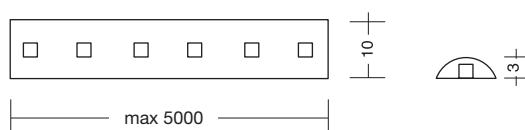

CE IP 64  
LED CRI 75-80 A

Per applicazione in luoghi asciutti o umidi  
in ambienti interni.  
Strip led flessibile con copertura in gel e biadesivo 3M.  
For application in dry or damp indoor.  
Flexible LED Strip with 3M adhesive and gel cover.

## CODICE ROLLA

9901	1 Natural white	Lm/m 1110 - 4000-4500°K
9906	6 Warm white	Lm/m 1080 - 2800-3300°K
9909	9 RGB	

## CODICE 10 CM STRIP

9991	1 Natural white	Lm/m 1110 - 4000-4500°K
9996	6 Warm white	Lm/m 1080 - 2800-3300°K
9999	9 RGB	

Il codice del prodotto è riferito a 10cm di strip  
In fase d'ordine precisare la misura in cm. della strip  
tenendo presente la misura di taglio della stessa.  
Code number refer to 10cm of the strip.  
Ordering, specify the cm. length of the strip considering  
the cutting measure of it

## ACCESSORI

Utilizzare profili da pag. 33 - Alimentatori da pag. 204 - Schemi assemblaggio da pag. 214  
Use profiles from page 33 - Drivers from page 204 - Assembly schemes from page 214





# STRIP FLEX 9,6 W/MT

Design Athena

Strip led flessibile con biadesivo 3M

Flexible led strip with glue 3M



LED/MT 120  
Potenza 9,6 W/MT  
Volts 24 Vdc  
Durata 30000h  
Separabile ogni 6 led 5 cm  
Temperatura -20° +40°C  
Lunghezza max mm 5000  
Corrente diretta 0,4 A/MT  
Cavo aliment. Rosso/nero cm 30

Led/mt 120  
Wattage 9,6 w/mt 0,4A/mt  
Voltage 24Vdc  
Lasting 30000 h  
Cutttable every 6 led 5cm  
Working temperature -20° +40°C  
Max length mm 5000  
Cable red/black cm 30

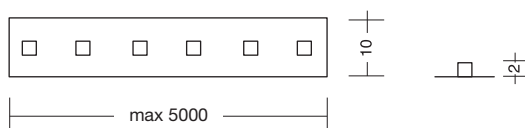

CE IP 20  
LED CRI 75-80 A

Installare su superfici dissipanti il calore.  
Applicazione in luoghi asciutti in ambienti interni  
Install only on dissipating surfaces.  
Application in a dry place indoors

## CODICE ROLLA

97401	■ 1 Natural white	Lm/m 800 - 4000-4500°K
97406	■ 6 Warm white	Lm/m 780 - 2800-3300°K

## CODICE 10 CM STRIP

97491	■ 1 Natural white	Lm/m 800 - 4000-4500°K
97496	■ 6 Warm white	Lm/m 780 - 2800-3300°K

Il codice del prodotto è riferito a 10cm di strip  
In fase d'ordine precisare la misura in cm. della strip  
tenendo presente la misura di taglio della stessa.  
Code number refer to 10cm of the strip.  
Ordering, specify the cm. length of the strip considering  
the cutting measure of it

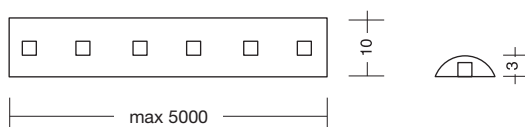

CE IP 64  
LED CRI 75-80 A

Per applicazione in luoghi asciutti o umidi  
in ambienti interni.  
Strip led flessibile con copertura in gel e biadesivo 3M.  
For application in dry or damp indoor.  
Flexible LED Strip with 3M adhesive and gel cover.

## CODICE ROLLA

97301	■ 1 Natural white	Lm/m 800 - 4000-4500°K
97306	■ 6 Warm white	Lm/m 780 - 2800-3300°K

## CODICE 10 CM STRIP

97391	■ 1 Natural white	Lm/m 800 - 4000-4500°K
97396	■ 6 Warm white	Lm/m 780 - 2800-3300°K

Il codice del prodotto è riferito a 10cm di strip  
In fase d'ordine precisare la misura in cm. della strip  
tenendo presente la misura di taglio della stessa.  
Code number refer to 10cm of the strip.  
Ordering, specify the cm. length of the strip considering  
the cutting measure of it

## ACCESSORI

Utilizzare profili da pag. 33 - Alimentatori da pag. 204 - Schemi assemblaggio da pag. 214  
Use profiles from page 33 - Drivers from page 204 - Assembly schemes from page 214

# STRIP FLEX 4,8 W/MT

Design Athena

Strip led flessibile con biadesivo 3M

Flexible led strip with glue 3M

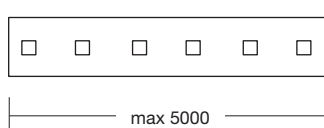

CE IP 20

LED CRI 75-80 **A**

## CODICE ROLLA

97101	■ 1 Natural white	Lm/m 400 - 4000-4500°K
97106	■ 6 Warm white	Lm/m 360 - 2800-3300°K

## CODICE 10 CM STRIP

97191	■ 1 Natural white	Lm/m 400 - 4000-4500°K
97196	■ 6 Warm white	Lm/m 360 - 2800-3300°K

LED/MT 60  
Potenza 4,8 W/MT  
Volts 24Vdc  
Durata 30000h  
Separabile ogni 6 led 10cm  
Temperatura -20° +40°C  
Lunghezza max mm15000  
Corrente diretta 0,2 A/MT  
Cavo aliment. Rosso/nero cm30

Led/mt 60  
Wattage 4,8 w/mt 0,2A/mt  
Voltage 24Vdc  
Lasting 30000 h  
Cuttable every 6 led 10cm  
Working temperature -20° +40°C  
Max length mm 15000  
Cable red/black cm30

Installare su superfici dissipanti il calore.  
Applicazione in luoghi asciutti in ambienti interni  
Install only on dissipating surfaces.  
Application in a dry place indoors

Il codice del prodotto è riferito a 10cm di strip  
In fase d'ordine precisare la misura in cm. della strip  
tenendo presente la misura di taglio della stessa.  
Code number refer to 10cm of the strip. Ordering, specify the cm.  
length of the strip considering the cutting measure of it

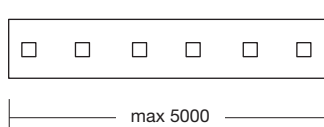

CE IP 64

LED CRI 75-80 **A**

## CODICE ROLLA

9701	■ 1 Natural white	Lm/m 400 - 4000-4500°K
9706	■ 6 Warm white	Lm/m 360 - 2800-3300°K
9702	■ 2 Blue	
9704	■ 4 Green	
9707	■ 7 Yellow	
9708	■ 8 Red	

## CODICE 10 CM STRIP

9791	■ 1 Natural white	Lm/m 400 - 4000-4500°K
9796	■ 6 Warm white	Lm/m 360 - 2800-3300°K
9792	■ 2 Blue	
9794	■ 4 Green	
9797	■ 7 Yellow	
9798	■ 8 Red	

Per applicazione in luoghi asciutti o umidi  
in ambienti interni.  
Strip led flessibile con copertura silicone  
e biadesivo 3M.  
For application in dry or damp indoor.  
Flexible LED Strip with 3M adhesive and silicon cover.

Il codice del prodotto è riferito a 10cm di strip  
In fase d'ordine precisare la misura in cm. della strip  
tenendo presente la misura di taglio della stessa.  
Code number refer to 10cm of the strip.  
Ordering, specify the cm. length of the strip considering  
the cutting measure of it

## ACCESSORI

Utilizzare profili da pag. 33 - Alimentatori da pag. 204 - Schemi assemblaggio da pag. 214  
Use profiles from page 33 - Drivers from page 204 - Assembly schemes from page 214

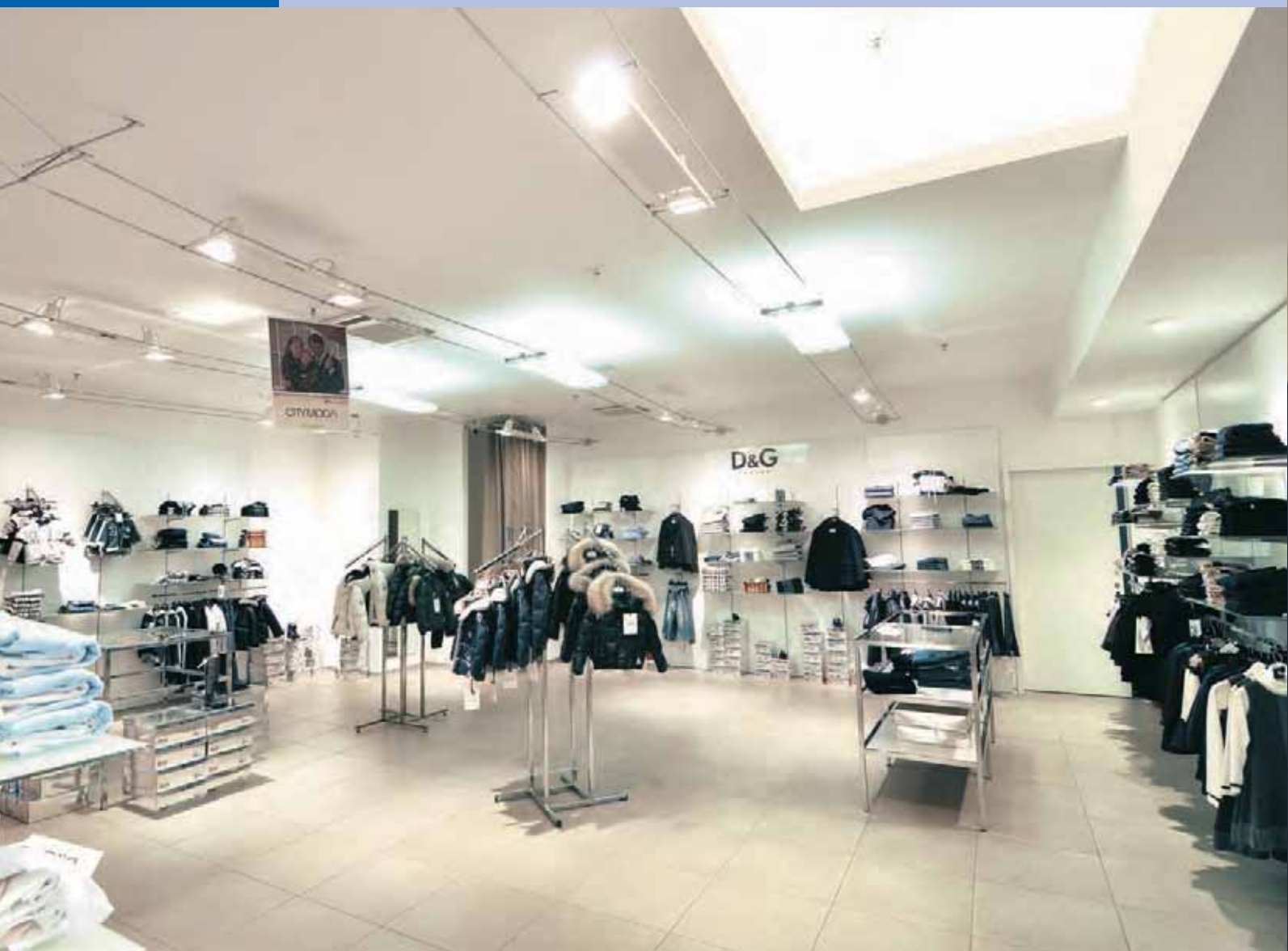

## FOCUS

*Design Athena*

Focus é un sistema a cavi 230V ideale per l'illuminazione di grandi spazi, uffici, show-room, negozi, ma utilizzabile anche in ambienti domestici come sale, cucine, corridoi. La vasta gamma degli accessori consente uno svariato utilizzo nella installazione del sistema, consentendo la tensione dello stesso in qualsiasi forma e di poter prendere l'alimentazione in qualsiasi punto del sistema.

L'apposito cavo a 2 conduttori consente inoltre sia l'accensione alternata che l'accensione simultanea dei corpi illuminanti, consentendo di alimentare gli stessi fino a 2500W per conduttore.

*Focus is a 230V cable system perfect for lighting large spaces, offices, show rooms and shops, but it can also be used in domestic environments such as lounges, kitchens and corridors. The vast range of accessories means the system can be installed in a variety of ways, making it possible to tension it in any shape and connect the electricity supply at any point in the system.*

*The two-conductor cable supplied also makes it possible to switch the luminaires on alternately or simultaneously, meaning they can be supplied with up to 2500W per conductor.*



# FOCUS 300

Design Athena

Sorgente led  
Led lighting source

INTERASSE 300 MM

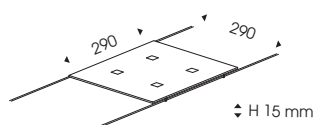

**028951** bianco NW - *white NW*

**028991** nero NW - *black NW*

220/240V LED 4x4,3W

Colori led  1 Natural white  
led colours 4000°K - 1580 lumen

**028956** bianco WW - *white WW*

**028996** nero WW - *black WW*

220/240V LED 4x4,3W

Colori led  6 Warm white  
led colours 3000°K - 1480 lumen

CE IP 20    LED CRI >80 



# FOCUS 300

Design Athena

Sorgente led

Led lighting source

INTERASSE 300 MM

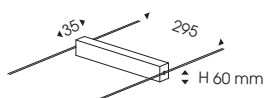

**029051** bianco NW - *white NW*

**029071** grigio NW - *grey NW*

**029091** nero NW - *black NW*

220/240V LED 11W Driver incluso - *Driver included*

Colori led  1 Natural white  
led colours 4000°K - 1450 lumen

**029056** bianco WW - *white WW*

**029076** grigio WW - *grey WW*

**029096** nero WW - *black WW*

220/240V LED 11W Driver incluso - *Driver included*

Colori led  6 Warm white  
led colours 3000°K - 1350 lumen

CE IP 40    LED CRI >80 

# FOCUS 300

Design Athena

Sorgente led  
Led lighting source

INTERASSE 300 MM

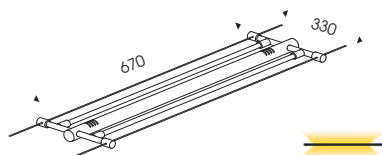

**029171** grigio NW - grey NW  
220/240V LED 2x12,4W Driver incluso - Driver included

Colori led  
led colours

- 1 Natural white  
4000°K - 3600 lumen

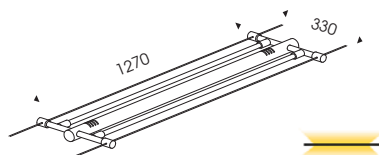

**029271** grigio NW - grey NW  
220/240V LED 2x24,8W Driver incluso - Driver included

Colori led  
led colours

- 1 Natural white  
4000°K - 7200 lumen

**029176** grigio WW - grey WW  
220/240V LED 2x12,4W Driver incluso - Driver included

Colori led  
led colours

- 6 Warm white  
3000°K - 3400 lumen

**029276** grigio WW - grey WW  
220/240V LED 2x24,8W Driver incluso - Driver included

Colori led  
led colours

- 6 Warm white  
3000°K - 6800 lumen

CE IP 20 LED CRI >80

CE IP 20 LED CRI >80

## ACCESSORI

Diffusore in policarbonato bianco serigrafato.  
Polycarbonate diffuser.



0212 per 0291

205

0215 per 0292

355



# FOCUS 300

Design Athena

Sorgente fluorescente

Fluorence lighting source

INTERASSE 300 MM

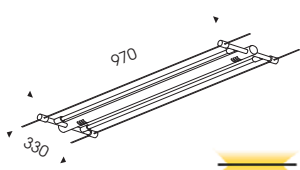
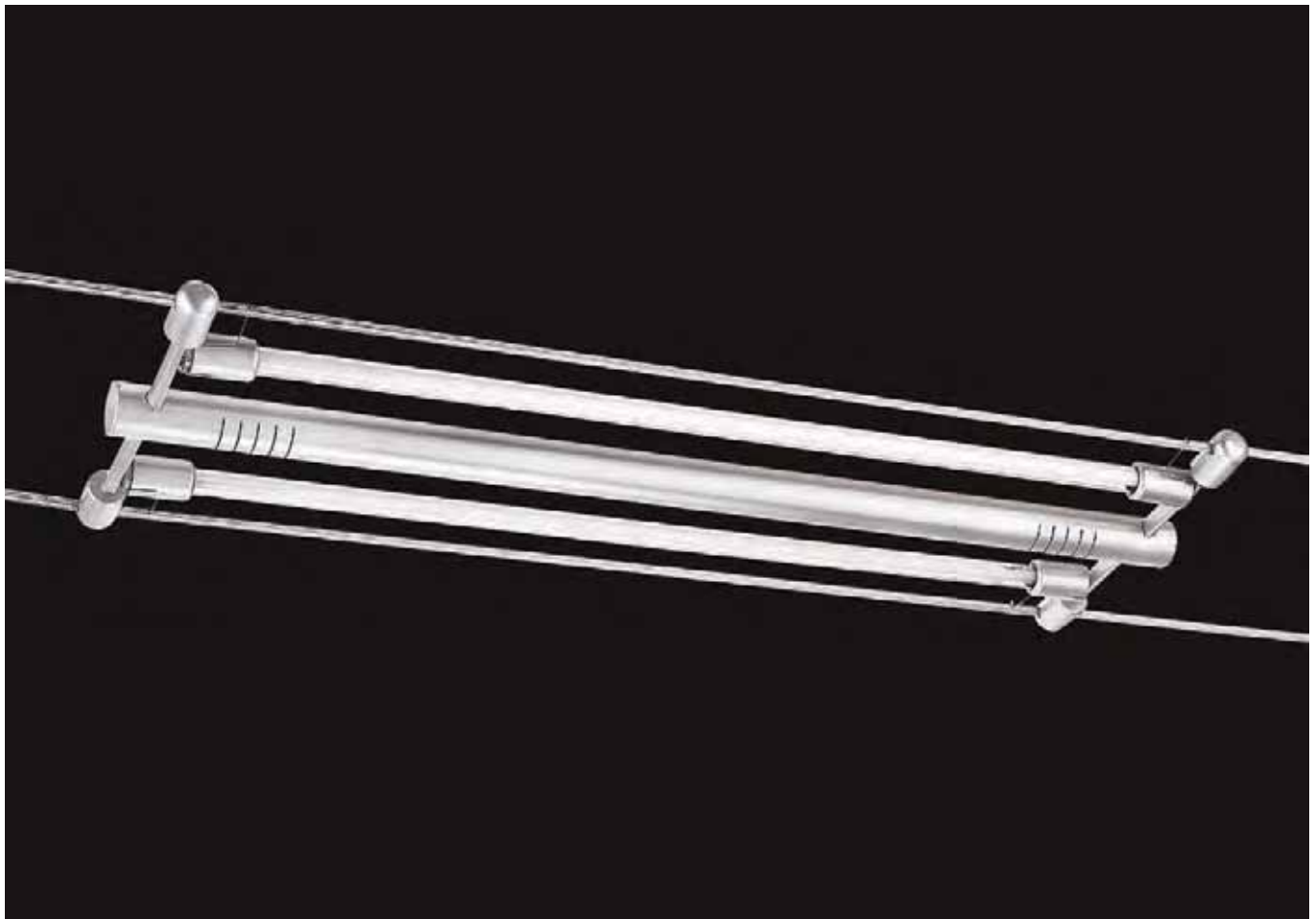

**0239 7** grigio met. - metal grey  
220/240V T5 2x39W max

CE IP 20    1600 

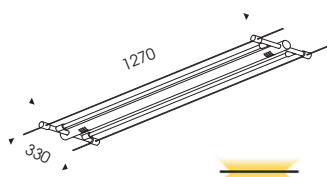



**0254 7** grigio met. - metal grey  
220/240V T5 2x54W max



CE IP 20    2050 

## ACCESSORI

Coppia Ottiche Microdarklight alluminio anodizzato brillante.  
Luce diretta/indiretta.  
Couple brilliant anodized aluminium optique Microdarklight. Direct/indirect light.



 **0221** Per sorgenti  
For sources 39W **0239**  280

 **0222** Per sorgenti  
For sources 54W **0254**  355

Diffusore in policarbonato bianco serigrafato.  
Polycarbonate diffuser.



 **0213** Per sorgenti  
For sources 39W **0239**  280

 **0215** Per sorgenti  
For sources 54W **0254**  355



# FOCUS 300

Design Athena

Sorgente alogena con vetro extrachiario

Lighting source with halogen lamp and extra clear glass

INTERASSE 300 MM

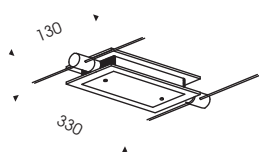

0243 7 grigio - grey

220/240V ECO R7S mm 117 160W

CE IP 20    

# FOCUS 300

Design Athena

Sorgente alogena con Pirex trasparente  
Lighting source with halogen lamp and extra clear glass

INTERASSE 300 MM

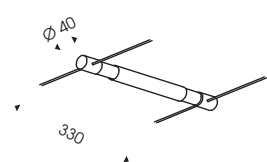

**0242 7** grigio - grey

220/240V ECO R7S mm 117 230W max



Sorgente alogena con pirex serigrafato/sabbiato  
Lighting source with halogen lamp and printed/mat glass-screen

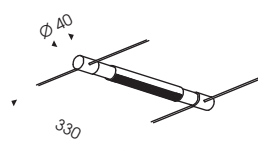

**0240 7** grigio met. - metal grey

220/240V ECO R7S mm 117 230W max



# FOCUS 300

Design Athena

Sorgente alogena o Led  
Halogen or Led lighting source

INTERASSE 300 MM

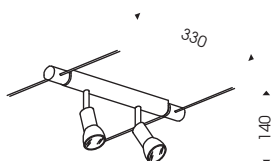

**0251 1** cromo - *chrome*  
220/240V GZ10 2x50W Halo  
220/240V 2x GU10 LED

CE IP 20    



Faretto orientabile in metallo  
*Adjustable spotlight*

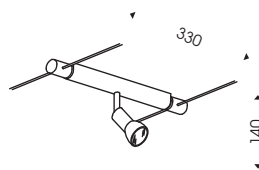

**0234 1** cromo - *chrome*  
220/240V GZ10 50W Halo  
220/240V GU10 LED

CE IP 20    

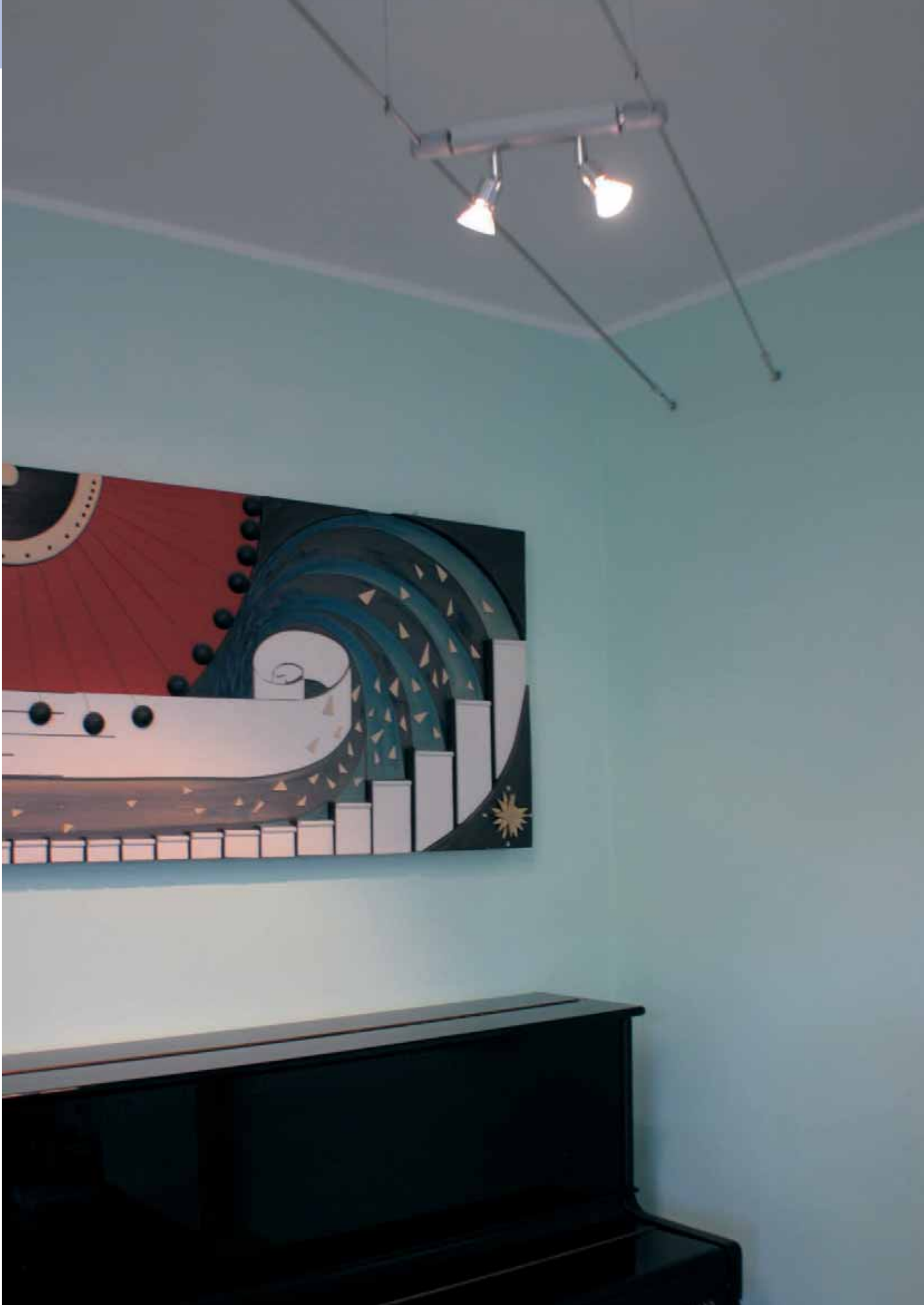

# FOCUS 300

Design Athena

Faretto orientabile in metallo  
Adjustable spotlight

INTERASSE 300 MM

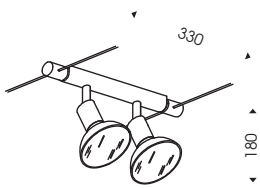
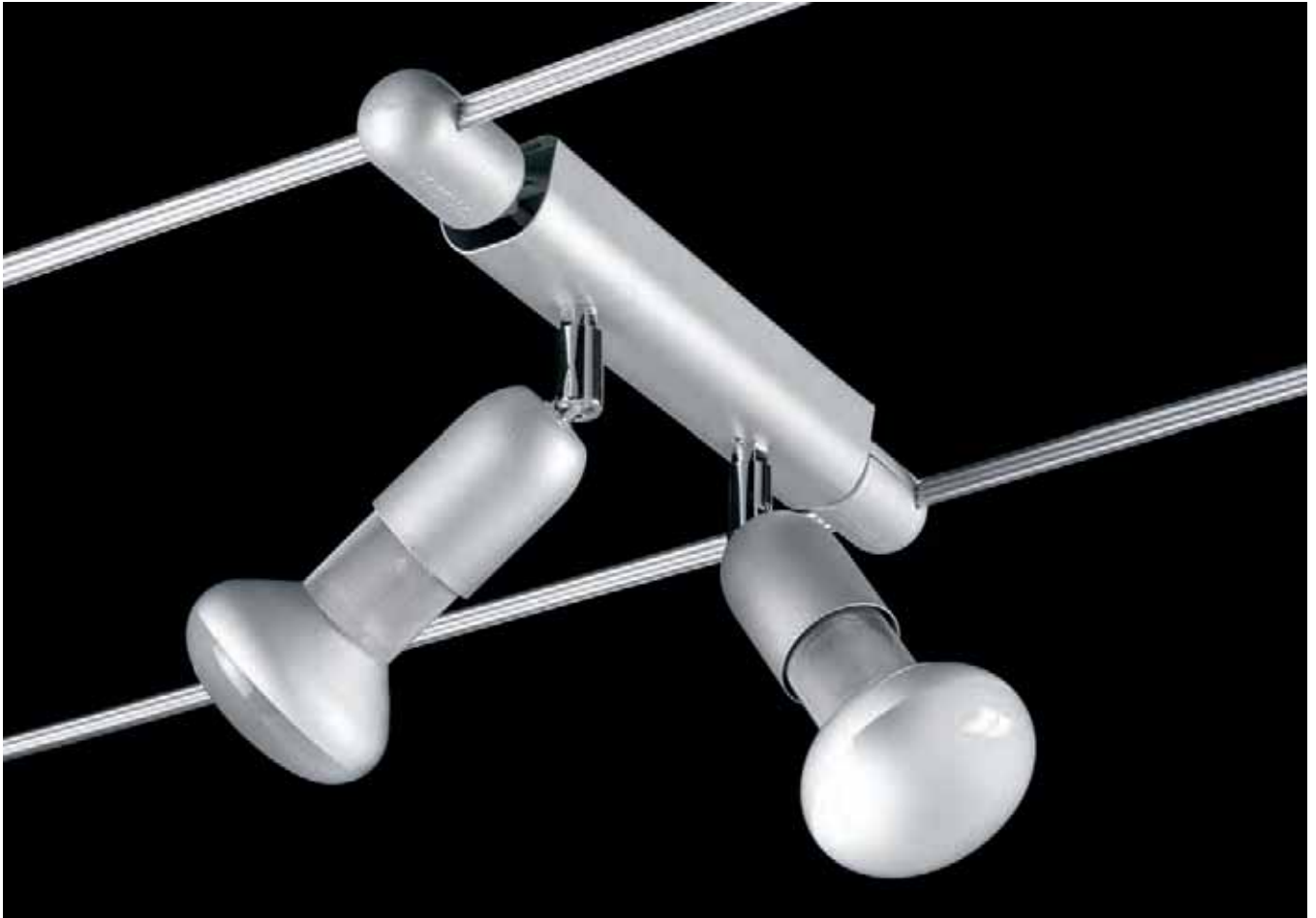

**0282 7** grigio met. - metal grey  
220/240V E27 2x60W max

CE IP 20    



Faretto orientabile in metallo  
Adjustable spotlight

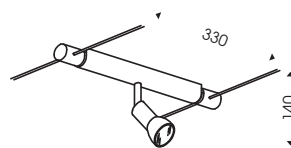

**0272 7** grigio met. - metal grey  
220/240V E27 60W max

CE IP 20    

# FOCUS 300

Design Athena

Faretto orientabile in metallo

Adjustable spotlight

INTERASSE 300 MM

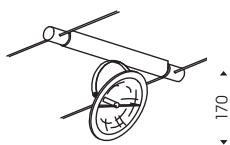

**021176** grigio WW - grey WW

220/240V AR111 LED 15,5W 40°

Colori led  
led colours

6 Warm white  
3000°K - 1250 lumen

CE IP 20    LED CRI >80 



# FOCUS 300

*Design Athena*



# FOCUS 300

Design Athena

## ACCESSORI



### 0200

Cavo a due conduttori in rame e uno in acciaio per accensioni alternate. Idoneo per l'applicazione di apparecchi in classe II  
*2 copper connection cables and one steel cable to obtain alternated lighting fitted for lamps CL II*



80



### 0207 7 grigio met. - metal grey

Supporto angolare parete 90°-120°  
*Angular wall support 90°-120°*



443



### 0202 7 grigio met. - metal grey

Alimentazione parete/soffitto applicabile in qualsiasi punto del sistema (senza cavi)  
*Ceiling fitted leaders that can be applied to any point of the system (without cables)*



246



### 0208 1 cromo - chrome

Coppia staffa sostegno + rinforzo per staffa altezza massima 250 mm  
*Couple ceiling support bracket + reinforcements bracket max height 250 mm*



343



### 0203 1 cromo - chrome

Coppia sostegno cavi per tesate molto lunghe o quando vi siano numerosi corpi lampade  
*Twin support cables for long sections or with many lamps*



168



### 0209 1 cromo - chrome

Kit tendicavo snodato composto da 4 tiranti e 4 isolanti - interasse 300 mm  
*Jointed cable 4 tightening and 4 insulating distance 300 mm*



310

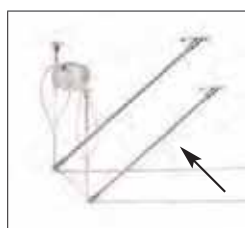

### 0204 1 cromo - chrome

Distanziatore per tendere i cavi a soffitto in assenza di pareti  
*Distance piece for tightening cables to ceiling without walls*



613



### 0210 7 grigio met. - metal grey

Kit tendicavo snodato composto da 4 tiranti, 2 isolanti e scatola per alimentazione elettrica interasse 300 mm  
*Jointed cable composed by 4 tightening, 2 insulating and electrical connectors, distance 300 mm*



470

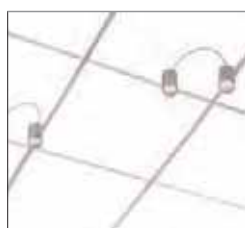

### 0205 7 grigio met. - metal grey

Coppia cavi alimentazione  
*Twin power supply cables*



106



### 0214 1 cromo - chrome

Kit per curve da 45° a 120° composto da staffa e rinforzo.  
*Kit for a curve from 45° to 120° degrees, composed by bracket and reinforcement.*



450



### 0206 7 grigio met. - metal grey

Coppia deviatori a parete  
*Wall deviation twin set*



66

# FOCUS 160

Design Athena

Sorgente led

Led source

INTERASSE 160 MM

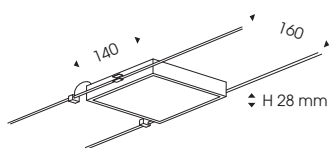

**045751** bianco NW - white NW

220/240V LED 13W

Colori led  
led colours

■ 1 Natural white  
4000°K - 1210 lumen

**045756** bianco WW - white WW

220/240V LED 13W

Colori led  
led colours

■ 6 Warm white  
3000°K - 1000 lumen

Colori policarbonato - Polycarbonate colours

□ 1 Trasparente - Transparent

■ 2 Blu - Blue

■ 7 Arancio - Orange

■ 6 Giallo - Yellow

■ 8 Rosso - Red

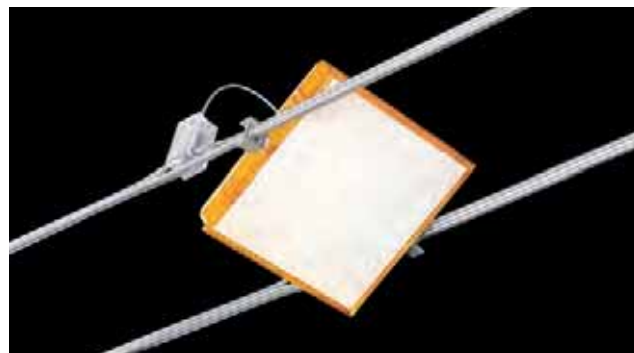

In fase d'ordine specificare  
colore policarbonato:  
Es 045751 2 = bianco NW blu

Specify polyc. colour when ordering:  
IP Es 045751 2 = white NW blue

CE IP 40    LED CRI >80 

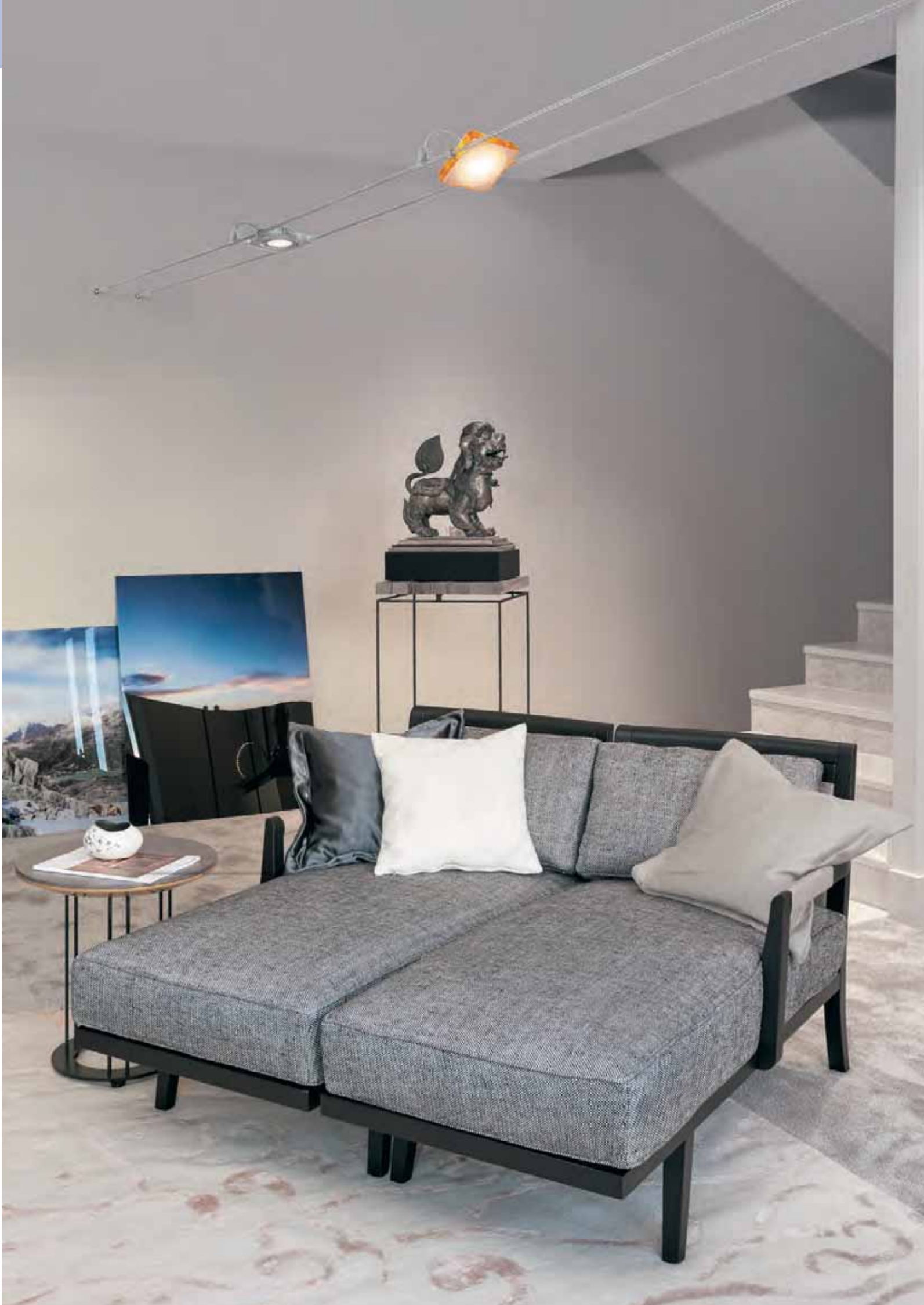

# FOCUS 160

Design Athena

Sorgente Led orientabile

Adjustable Led source

INTERASSE 160 MM

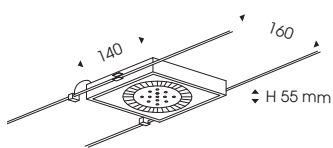

**045856** bianco WW - white WW

220/240V LED AR111 15,5W 40°

Colori led ■ 6 Warm white  
led colours 3000°K - 1250 lumen

Colori policarbonato - Polycarbonate colours

1 Trasparente - Transparent

2 Blu - Blue

7 Arancio - Orange

6 Giallo - Yellow

8 Rosso - Red

In fase d'ordine specificare  
colore policarbonato:  
Es 045856 2 = bianco WW blu

Specify polyc. colour when ordering:  
IP Es 045856 2 = white WW blue

CE IP 40 LED CRI >80

# FOCUS 160

Design Athena

Sorgente Led orientabile

Adjustable Led source

INTERASSE 160 MM

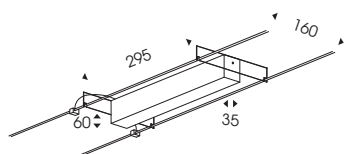
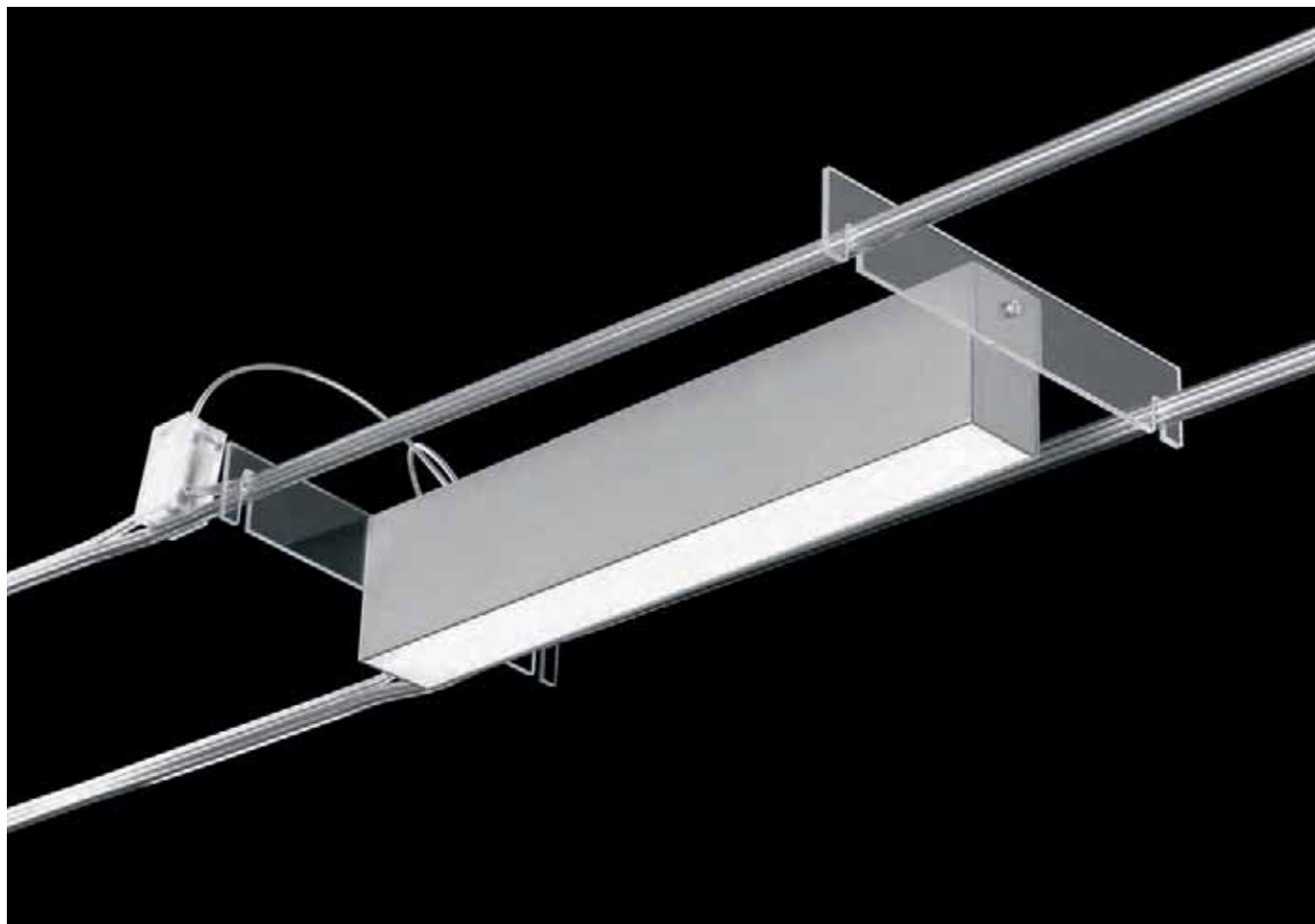

**049051** bianco NW - white NW

**049071** grigio NW - grey NW

**049091** nero NW - black NW

220/240V LED 11W Driver incluso - Driver included

Colori led  1 Natural white  
led colours 4000°K - 1450 lumen

**049056** bianco WW - white WW

**049076** grigio WW - grey WW

**049096** nero WW - black WW

220/240V LED 11W Driver incluso - Driver included

Colori led  6 Warm white  
led colours 3000°K - 1350 lumen

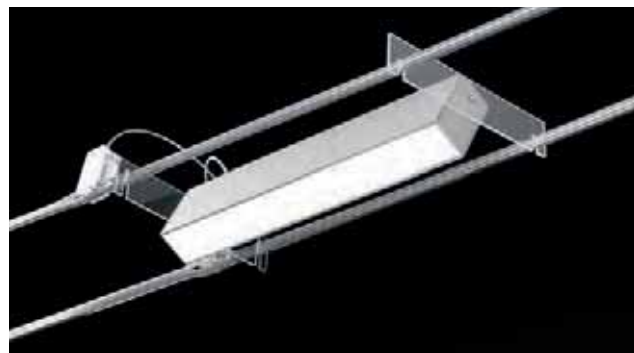

# FOCUS 160

Design Athena

Faretti orientabili in metallo

Adjustable spotlight

INTERASSE 160 MM

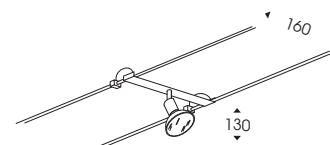

**0472 7** grigio met - metal grey

220/240V E27 60W max

CE IP 20   

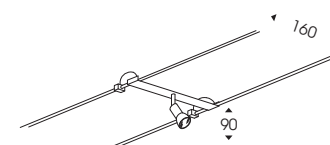

**0434 1** cromo - chrome

220/240V GZ10 50W Halo

220/240V GU10 LED

CE IP 20   

# FOCUS 160

Design Athena

INTERASSE 160 MM

## ACCESSORI



### 0200

Cavo a due conduttori in rame e uno in acciaio per accensioni alternate. Idoneo per l'applicazione di apparecchi in classe II  
*2 copper connection cables and one steel cable to obtain alternated lighting fitted for lamps CL II*



80



### 0207 7 grigio met. - metal grey

Supporto angolare parete 90°-120°  
*Angular wall support 90°-120°*



443



### 0202 7 grigio met. - metal grey

Alimentazione parete/soffitto applicabile in qualsiasi punto del sistema (senza cavi)  
*Ceiling fitted leaders that can be applied to any point of the system (without cables)*



246



### 0208 1 cromo - chrome

Coppia staffa sostegno + rinforzo per staffa altezza massima 250 mm  
*Couple ceiling support bracket + reinforcements bracket max height 250 mm*



343



### 0203 1 cromo - chrome

Coppia sostegno cavi per tesate molto lunghe o quando vi siano numerosi corpi lampade  
*Twin support cables for long sections or with many lamps*



168



### 0209 1 cromo - chrome

Kit tendicavo snodato composto da 4 tiranti e 4 isolanti - interasse 160 mm  
*Jointed cable 4 tightening and 4 insulating distance 160 mm*



310

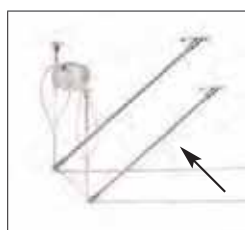

### 0204 1 cromo - chrome

Distanziatore per tendere i cavi a soffitto in assenza di pareti  
*Distance piece for tightening cables to ceiling without walls*



613



### 0210 7 grigio met. - metal grey

Kit tendicavo snodato composto da 4 tiranti, 2 isolanti e scatola per alimentazione elettrica interasse 160 mm  
*Jointed cable composed by 4 tightening, 2 insulating and electrical connectors, distance 160 mm*



470

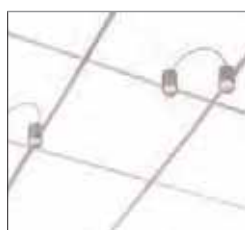

### 0205 7 grigio met. - metal grey

Coppia cavi alimentazione  
*Twin power supply cables*



106



### 0214 1 cromo - chrome

Kit per curve da 45° a 120° composto da staffa e rinforzo.  
*Kit for a curve from 45° to 120° degrees, composed by bracket and reinforcement.*



450



### 0206 7 grigio met. - metal grey

Coppia deviatori a parete  
*Wall deviation twin set*



66





Estetica New Fashion - Mozzate



### Faretto orientabile in metallo

*Adjustable spotlight*

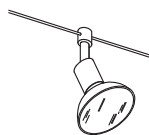

▲  
210  
▼

**0172 7** grigio met. - metal grey  
220/240V E27 60W max

CE IP 20   

# FOCUS 1

Design Athena

Faretti orientabili in metallo

Adjustable spotlight

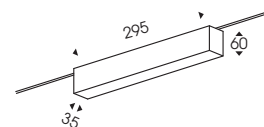
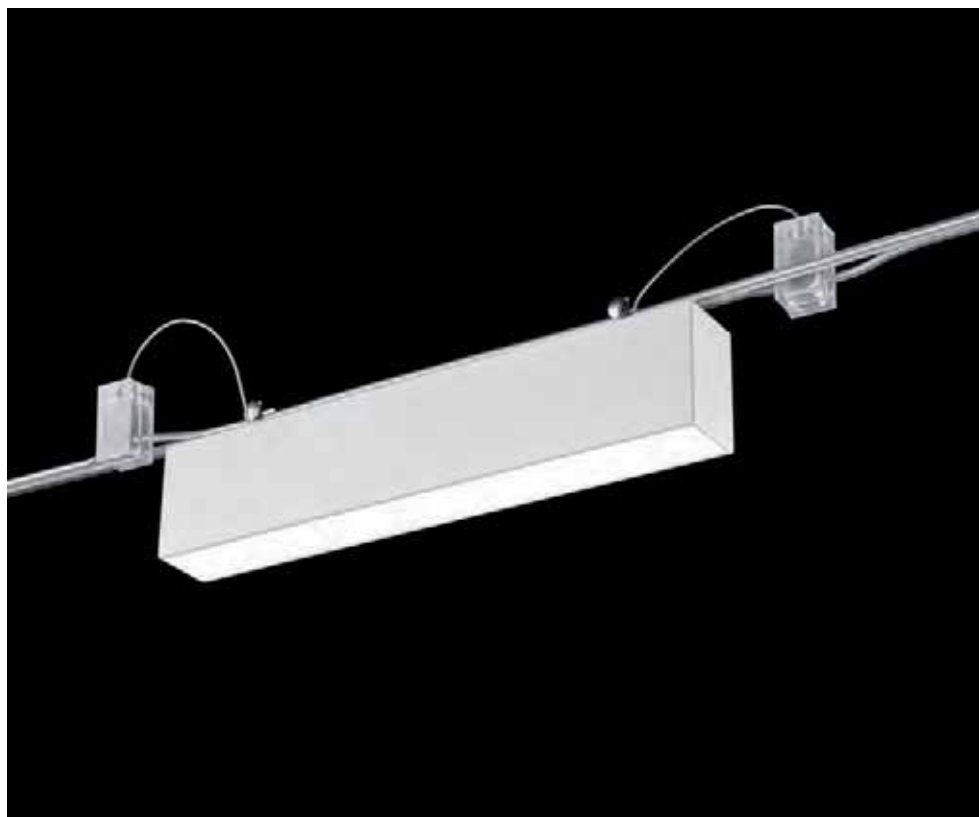

**019051** bianco NW - *white NW*

**019071** grigio NW - *grey NW*

**019091** nero NW - *black NW*

220/240V LED 11W

Driver incluso - *Driver included*

Colori led | *led colours*

■ 1 Natural white  
4000°K - 1450 lumen

**019056** bianco WW - *white WW*

**019076** grigio WW - *grey WW*

**019096** nero WW - *black WW*

220/240V LED 11W

Driver incluso - *Driver included*

Colori led | *led colours*

■ 6 Warm white  
3000°K - 1350 lumen

CE IP 20   

670

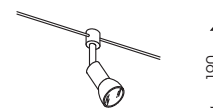

**0134 1** cromo - *chrome*

220/240V GZ10 50W Halo

220/240V GU10 LED

CE IP 20   

116

# FOCUS 1

Design Athena

Sorgente fluorescente e Led

Fluorecence and Led lighting source

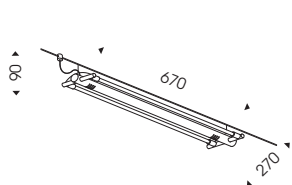

**019171** grigio NW - grey WW

220/240V LED 2x12,4W

Driver incluso - Driver included

Colori led ■ 1 Natural white  
led colours 4000°K - 3600 lumen

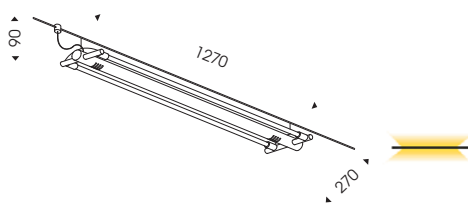

**019271** grigio NW - grey WW

220/240V LED 2x24,8W

Driver incluso - Driver included

Colori led ■ 1 Natural white  
led colours 4000°K - 7200 lumen

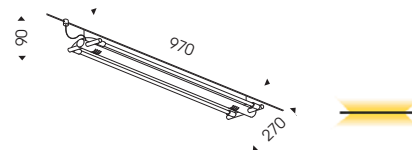

**01397** grigio met. - metal grey

220/240V T5 2x39W

CE IP 20

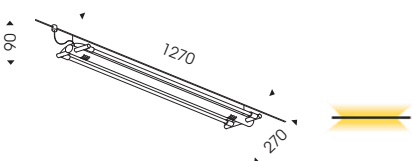

**01547** grigio met. - metal grey

220/240V T5 2x54W

CE IP 20

**019176** grigio WW - grey WW

220/240V LED 2x12,4W

Driver incluso - Driver included

Colori led ■ 6 Warm white  
led colours 3000°K - 3400 lumen

**019276** grigio WW - grey WW

220/240V LED 2x24,8W

Driver incluso - Driver included

Colori led ■ 6 Warm white  
led colours 3000°K - 6800 lumen

CE IP 20

CE IP 20

CE IP 20

# FOCUS 1

Design Athena



## 0100

Cavo a due conduttori in rame e uno in acciaio.  
Idoneo per l'applicazione di apparecchi in classe II

*2 copper connection cables for lamps CL II*



80



## 0207 7 grigio met. - metal grey

Supporto angolare parete 90°-120°

*Angular wall support 90°-120°*



443



## 0102 7 grigio met. - metal grey

Alimentazione applicabile in qualsiasi punto del sistema (senza cavi)

*Ceiling fitted leaders that can be applied to any point of the system (without cables)*



204



## 0108 1 cromo - chrome

Staffa sostegno + rinforzo per staffa

*Ceiling support bracket + reinforcements bracket*



200



## 0103 1 cromo - chrome

Sostegno cavi per tesate molto lunghe o quando vi siano numerosi corpi lampade

*Support cables for long sections or with many lamps*



84



## 0109 1 cromo - chrome

Kit tendicavo snodato composto da 2 tiranti e 2 isolanti

*Jointed cable 2 tightening and 2 insulating*



156



## 0106 7 grigio met. - metal grey

Deviatori a parete

*Wall deviators*



34



## 0110 7 grigio met. - metal grey

Kit tendicavo snodato composto da 2 tiranti, 1 isolante e scatola per alimentazione elettrica

*Jointed cable composed by 2 tightening and 1 insulating and electrical connectors*



336

## ACCESSORI

Coppia Ottiche Microdarklight alluminio anodizzato brillante.

Luce diretta/indiretta.

*Couple brilliant anodized aluminium optique Microdarklight. Direct/indirect light.*



**0221** Per sorgenti

*For source 39W 0139*



280



**0222** Per sorgenti

*For source 54W 0154*



355

Diffusore in policarbonato

bianco serigrafato.

*Polycarbonate diffuser.*



**0216** Per sorgenti

*For source 0191*



235



**0217** Per sorgenti

*For source 0139*



280



**0218** Per sorgenti

*For sources 0154 - 0192*



355







Mediocasa - Crema - Realizzazione effettuata da Zighetti Illuminazione

## ACCESSORI

Coppia Ottiche Microdarklight alluminio anodizzato brillante.  
Luce diretta/indiretta.  
*Couple brilliant anodized aluminium optique Microdarklight. Direct/indirect light.*







 **0221** Per sorgenti  
For sources **39W 0253**  **280**



 **0222** Per sorgenti  
For sources **54W 0255**  **355**

Diffusore in policarbonato  
bianco serigrafato.  
*Polycarbonate diffuser.*



 **0216** Per sorgenti  
For source **0256**  **235**

 **0217** Per sorgenti  
For source **0253**  **180**

 **0218** Per sorgenti  
For sources **0255 - 0257**  **355**

# FOCUS

Design Athena

## Sospensione fluorescente e Led

Fluorescence and Led light suspension

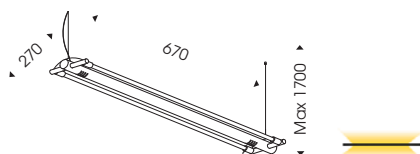

**025671** grigio NW - grey NW

220/240V LED 2x12,4W

Driver incluso - Driver included

Colori led led colours ■ 1 Natural white  
4000°K - 3600 lumen

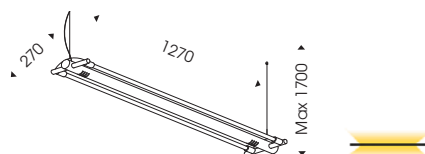

**025771** grigio NW - grey NW

220/240V LED 2x24,8W

Driver incluso - Driver included

Colori led led colours ■ 1 Natural white  
4000°K - 7200 lumen

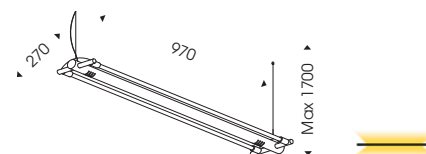

**02537** grigio met. - metal grey

220/240V T5 2x39W

CE IP 20

**025676** grigio WW - grey WW

220/240V LED 2x12,4W

Driver incluso - Driver included

Colori led led colours ■ 6 Warm white  
3000°K - 3400 lumen

**025776** grigio WW - grey WW

220/240V LED 2x24,8W

Driver incluso - Driver included

Colori led led colours ■ 6 Warm white  
3000°K - 6800 lumen

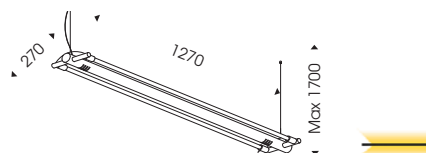

**02557** grigio met. - metal grey

220/240V T5 2x54W

CE IP 20

CE IP 20 LED CRI >80

CE IP 20 LED CRI >80



Bar Movida - Turate

## TWIN

Design Athena

INTERASSE 135 MM CON FARETTI CON ADATTATORE.  
INTERASSE DISTANZA MAX 2900 MM CON SOSPENSIONI VETRO.

Twin è un sistema a bassa tensione (12 V); sviluppato su un doppio cavo elettrificato, risulta adatto per ogni soluzione illuminotecnica che voglia essere allo stesso tempo pratica, semplice nell'installazione, elegante e di grande effetto. Data l'essenzialità delle sue linee risulta ottimale per ogni ambiente, che sia un'abitazione, uno show-room o un luogo più sobrio quale potrebbe essere un museo o una galleria d'arte. Con l'ampia gamma di sorgenti luminose e di componenti, la struttura ottiene il massimo della flessibilità.

Alla versatilità del sistema è affiancato inoltre un elevato standard qualitativo raggiunto basandone lo sviluppo sulle caratteristiche principali della nostra produzione: estetica, sicurezza e praticità. Si consiglia di restare entro una linea continua di max 8 m. alimentata da un trasformatore toroidale.

*Twin is a 12V low-voltage system. Based on an electrified double cable it is suitable for any technical lighting solution that needs to be practical, easy to install, elegant and of great effect. Thanks to its clean lines it is suitable for any environment, whether it may be a home, showroom or a more austere setting such as a museum or art gallery. The structure offers great flexibility thanks to the wide range of light sources and components available.*

*Alongside its versatility, the system also boasts a high standard of quality obtained by basing its development on the main features of our production range: appearance, safety and practicality. We recommend staying within a maximum continuous line of 10 metres with power supplied with a toroidal transformer.*

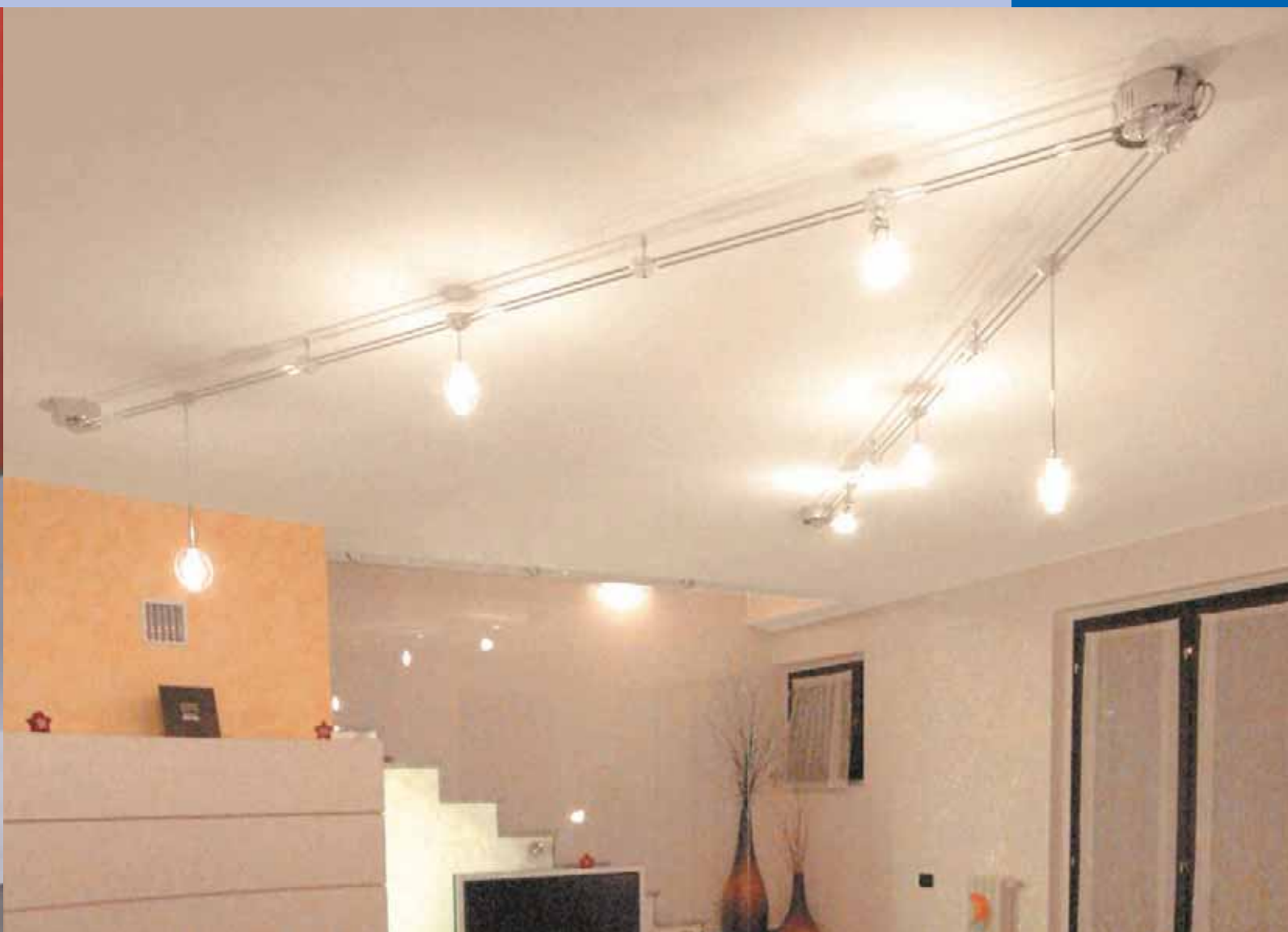

## FLIGHT SYSTEM

*Design Athena*

Flight system é il sistema a bassa tensione (12V) che si sviluppa su binario rigido. Particolarmente indicato per l'illuminazione privata, ma non solo, consente di portare le sorgenti luminose in qualsiasi punto dell'ambiente, in presenza di punti luce sia a parete che a soffitto. Le diverse composizioni possibili e le numerose sorgenti disponibili consentono di soddisfare le esigenze più svariate.

È consigliabile l'utilizzo di una lunghezza massima per alimentazione con trasformatore toroidale non superiore a 6 metri.

*Flight system is a 12V low-voltage system based on a rigid track and ideal for any kind of lighting. It is possible to move the lights to any point in the room with both wall and ceiling lights. The various compositions and lights available make it possible to meet the most varied needs. We recommend using a maximum length of 6 meters with power supplied with a toroidal transformer.*



# TWIN

Design Athena

Sorgente led orientabile

Adjustable Led lighting source

INTERASSE 135 MM

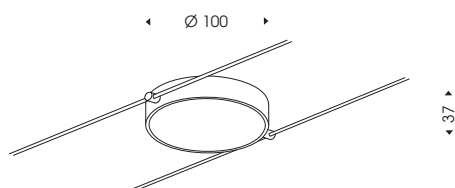

**035851** bianco NW - white NW

per/for **Twin**

12V 4W LED

Colori led  1 Natural white  
led colours 4000°K - 520 lumen

**035856** bianco WW - white WW

per/for **Twin**

12V 4W LED

Colori led  6 Warm white  
led colours 3000°K - 480 lumen

CE IP 40    LED CRI >80 

## ACCESSORI

Trasformatori e accessori: Twin da pag. 95  
Transformers and accessories: Twin from page 95



# TWIN

Design Athena

Sorgente led orientabile

Adjustable Led lighting source

INTERASSE 135 MM

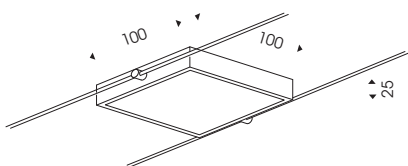

**035751** bianco NW - white NW

per/for **Twin**

12V 4W LED

Colori led  1 Natural white  
led colours 4000°K - 520 lumen

**035756** bianco WW - white WW

per/for **Twin**

12V 4W LED

Colori led  6 Warm white  
led colours 3000°K - 480 lumen

CE IP 40    LED CRI >80 

Colori policarbonato - Polycarbonate colours

- |                                                      |                                             |
|------------------------------------------------------|---------------------------------------------|
| <input type="checkbox"/> 1 Trasparente - Transparent | <input type="checkbox"/> 7 Arancio - Orange |
| <input type="checkbox"/> 2 Blu - Blue                | <input type="checkbox"/> 8 Rosso - Red      |
| <input type="checkbox"/> 6 Giallo - Yellow           |                                             |

In fase d'ordine specificare  
colore policarbonato:  
Es 035751 2 = bianco NW blu

Specify polyc. colour when ordering:  
IP Es 035751 2 = white NW blue

## ACCESSORI

Trasformatori e accessori: Twin da pag. 95  
Transformers and accessories: Twin from page 95



# TWIN & FLIGHT SYSTEM

Design Athena

Sorgenti Led e Halo

Led and Halo lighting sources



◀ 250 ▶

**0353 1** cromo - chrome

per/for **Twin**

12v G5,3 50W max Halo

12v G5,3 LED

CE IP20     



**0354 1** cromo - chrome

per/for **Twin e Flight system**

12v G5,3 50W max Halo

12v G5,3 LED

CE IP20     

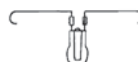

◀ 240 ▶

**0355 1** cromo - chrome

per/for **Twin**

12v G6,35 50W max Halo

12v LED

CE IP20     

## ACCESSORI

Trasformatori e accessori: Twin da pag. 95 Flight da pag. 98

Transformers and accessories: Twin from page 95 Flight from page 98



# TWIN & FLIGHT SYSTEM

Design Athena

Sorgenti Led e Halo orientabili

Led and Halo adjustable lighting sources



2010

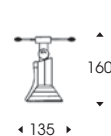

2011



**2010 1** cromo - chrome

per/for **Twin**

Interasse 135 mm

**2011 1** cromo - chrome

per/for **Flight system**

12v G6,35 50W max

CE IP20



1910

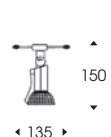

1911

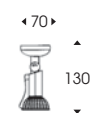

**1910 1** cromo - chrome

per/for **Twin**

Interasse 135 mm

**1911 1** cromo - chrome

per/for **Flight system**

12v G5,3 50W max Halo

12v G5,3 LED

CE IP20

## ACCESSORI

Trasformatori e accessori: Twin da pag. 95 Flight da pag. 98

Transformers and accessories: Twin from page 95 Flight from page 98

# TWIN & FLIGHT SYSTEM

Design Athena

Sorgenti Led e Halo

Led and Halo lighting sources

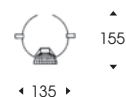

**3110 1** cromo - *chrome*  
per/for **Twin**  
Interasse 135 mm

12v G5,3 50W max Halo  
12v G5,3 LED

CE IP20     



**3310**



  
**150**

**3311**



  
**156**

**3310 1** cromo - *chrome*  
per/for **Twin**  
Interasse 135 mm

**3311 1** cromo - *chrome*  
per/for **Flight system**  
12v G5,3 LED

CE IP20    

## ACCESSORI

Trasformatori e accessori: Twin da pag. 95 Flight da pag. 98  
Transformers and accessories: Twin from page 95 Flight from page 98





# TWIN & FLIGHT SYSTEM

Design Athena

Sorgenti Halo

Halo Lighting sources



3010

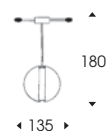

3011



**3010 1** cromo - chrome

per/for **Twin**

Interasse 135 mm

**3011 1** cromo - chrome

per/for **Flight system**

12v G6,35 50W max

CE IP 20



4610

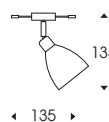

4611

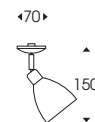

**4610 1** cromo - chrome

per/for **Twin**

Interasse 135 mm

**4611 1** cromo - chrome

per/for **Flight system**

12v G6,35 50W max

CE IP 20

## ACCESSORI

Trasformatori e accessori: Twin da pag. 95 Flight da pag. 98

Transformers and accessories: Twin from page 95 Flight from page 98

# TWIN & FLIGHT SYSTEM

Design Athena

Sorgenti Led e Halo

Led and Halo lighting sources



4510

4511

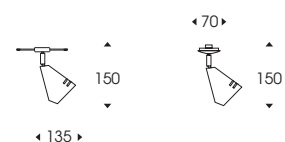

**4510 1** cromo - chrome

per/for **Twin**

Interasse 135 mm

**4511 1** cromo - chrome

per/for **Flight system**

12v G5,3 50W max Halo

12v G5,3 LED

CE IP 20     



1410

1411



 180

 180

**1410 7** grigio met - metal grey

per/for **Twin**

Interasse 135 mm

**1411 7** grigio met - metal grey

per/for **Flight system**

12v G53 AR111 75W max Halo

12v G53 LED AR111

CE IP 20    



# TWIN & FLIGHT SYSTEM

Design Athena

Sospensioni con cavo cm 600 - Utilizzabile su sistemi Flight o Twin con interasse più largo fino a mm 2900 max

Suspensions with wire cm 600 - Usable on Flight System or Twin System with large interaxis distance

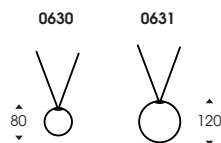

**0630 1** cromo - chrome (Ø80)

**0631 1** cromo - chrome (Ø120)

per/for Twin & Flight system

**9843** Set 5 cristalli - set 5 crystals

12v G6,35 50W max

12v LED



Inserti in cristallo

9843 9843 9843  
 ■ 2 ■ 5 ■ 8

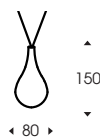

**0632 1** cromo - chrome

per/for Twin & Flight system

12v G4 20W max

12v LED

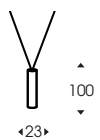

**0633 1** cromo - chrome

per/for Twin & Flight system

12v G6,35 50W max

12v LED

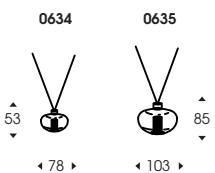

**0634 1** cromo - chrome 12v G4 20W max

**0635 1** cromo - chrome 12v G6,35 50W max

per/for Twin & Flight system

12v LED



## ACCESSORI

Trasformatori e accessori: Twin da pag. 95 Flight da pag. 98  
 Transformers and accessories: Twin from page 95 Flight from page 98

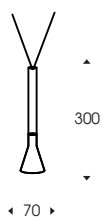
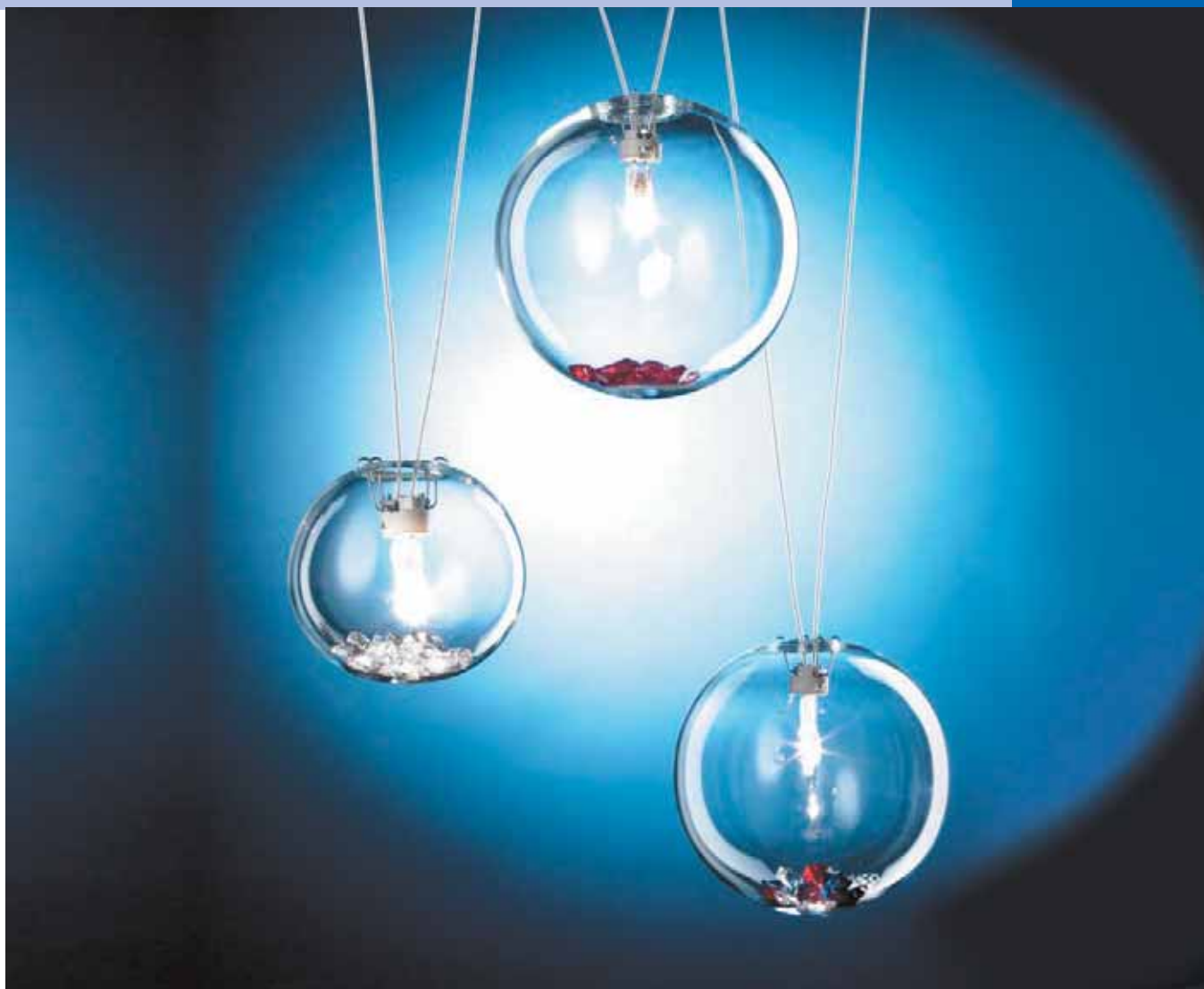

**0342** Accessorio tenuta cavi  
 Accessories for cables

**0639 1** cromo - chrome

per/for Twin &amp; Flight system

12v G5,3 50W max Halo

12v G6,35 50W max

12v G5,3 LED

◀ 70 ▶

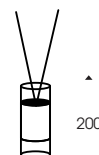

◀ 85 ▶

**0640 1** cromo - chrome

per/for Twin &amp; Flight system

12v G5,3 50W max

12v G6,35 50W max

12v G5,3 LED



## ACCESSORI

Trasformatori e accessori: Twin da pag. 95 Flight da pag. 98  
 Transformers and accessories: Twin from page 95 Flight from page 98



**0342** Accessorio tenuta cavi  
 Accessories for cables















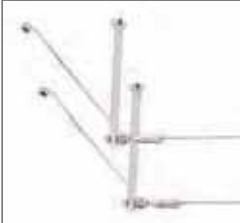











TWIN

Design Athena

TWIN INTERASSE 135 MM

## ACCESSORI

	<p><b>0203 1</b> cromo - chrome Coppia sostegno cavi per tesate molto lunghe o quando vi siano numerosi corpi lampade <i>Twin support cables for long sections or with many lamps</i></p> <p> <b>84</b></p>		<p><b>0335 1</b> cromo - chrome (H 250 mm) Staffa sostegno a parete <i>Wall support bracket</i></p> <p> <b>68</b></p>	
	<p><b>0208 1</b> cromo - chrome (H. 250 mm) Coppia staffa sostegno + coppia rinforzo per staffa <i>Pair of support bracket + pair of reinforcement brackets</i></p> <p> <b>343</b></p>		<p><b>0336 1</b> cromo - chrome (H 250 mm) Kit per curve da 45° a 120° + staffa+rinforzo <i>Kit for a curve from 45° to 120° degrees + brackets + reinforcements</i></p> <p> <b>400</b></p>	
	<p><b>0328 1</b> cromo - chrome Coppia alimentazione <i>Couple of power accessories</i></p> <p> <b>33</b></p>		<p><b>0338 1</b> cromo - chrome Kit per curva regolabile parete/soffitto <i>Wall/ceiling adjustable curve couple</i></p> <p> <b>320</b></p>	
		<p><b>0319</b> Non isolato - <i>Not insulated</i> mmq. 6 - 30A <b>0329</b> Isolato - <i>Insulated</i> mmq. 6 - 25A Cavo rame interasse mm. 135 <i>Copper cable axle base mm. 135</i></p> <p> <b>55</b></p>		<p><b>0339 1</b> cromo - chrome (L 70 mm) Coppia giunti isolante <i>Insulating joint couples</i></p> <p> <b>36</b></p>
	<p><b>0330 1</b> cromo - chrome Kit tendicavo snodato - 4 tiranti <i>Jointed cable tightening kit</i></p> <p> <b>284</b></p>		<p><b>0340 1</b> cromo - chrome (H 95 mm) Coppia staffa sostegno <i>Pair of ceiling support brackets</i></p> <p> <b>90</b></p>	
	<p><b>0331 1</b> cromo - chrome (H 250 mm) Coppia staffa sostegno <i>Pair of ceiling support brackets</i></p> <p> <b>308</b></p>		<p><b>0341 1</b> cromo - chrome (H 95 mm) Coppia staffa sostegno <i>Pair of ceiling support brackets</i></p> <p> <b>30</b></p>	



# TWIN

Design Athena

Contenitore in metallo con trasformatore toroidale 230/12V completo di coppia di alimentazione.

Box with toroidal transformer 230/12V with feed supply couple.

TWIN INTERASSE 135 MM

## ACCESSORI

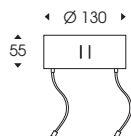

**0823 1** cromo - *chrome* (50 W)

**0823 5** bianco - *white* (50 W)

**0824 1** cromo - *chrome* (100 W)

**0824 5** bianco - *white* (100 W)

CE IP 20

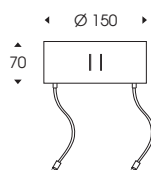

**0826 1** cromo - *chrome* (200 W)

**0826 5** bianco - *white* (200 W)

**0827 1** cromo - *chrome* (300 W)

**0827 5** bianco - *white* (300 W)

**0849 1** cromo - *chrome* (400 W)

**0849 5** bianco - *white* (400 W)

CE IP 20



## TWIN

Design Athena

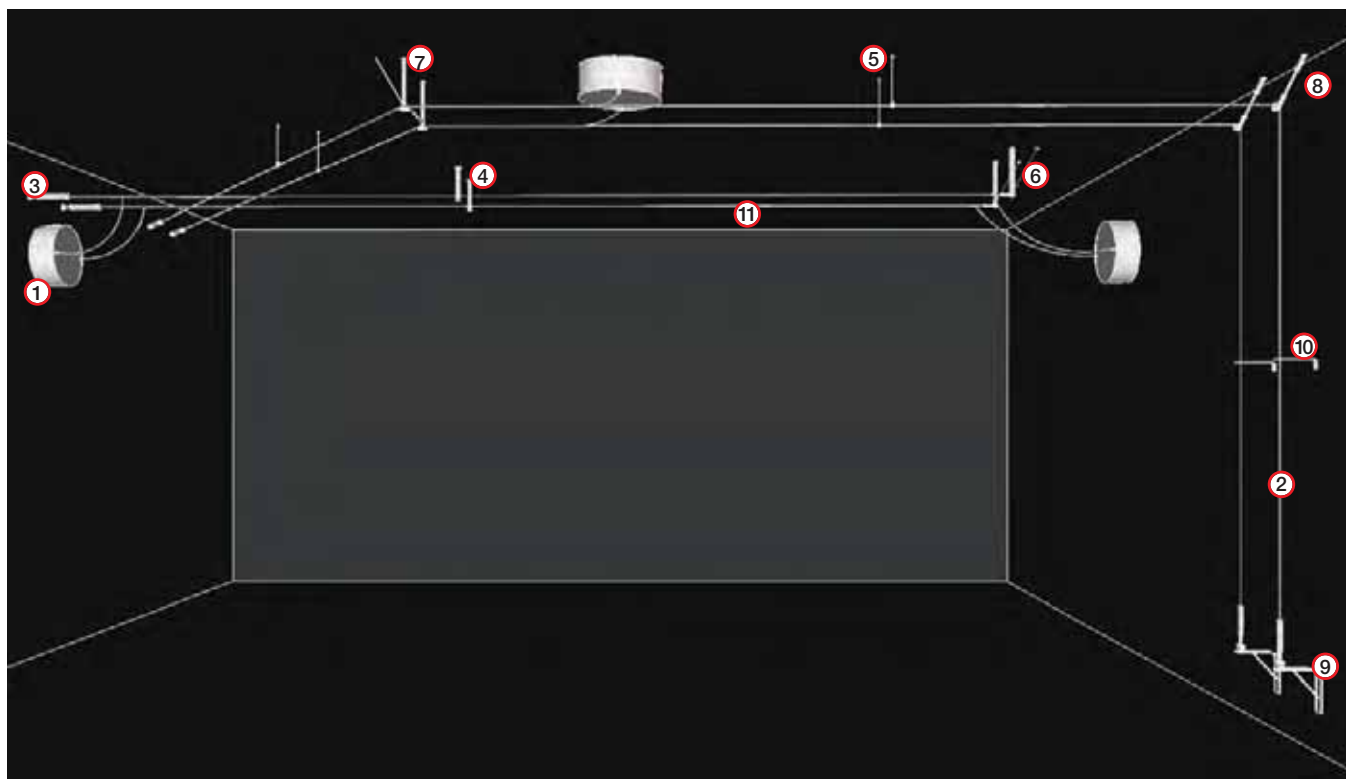





























- |                                                                                                                                                                                                                                                                                                                          |                                                                                                                                                                                                                                        |                                                                                                          |                                                                                                         |
|--------------------------------------------------------------------------------------------------------------------------------------------------------------------------------------------------------------------------------------------------------------------------------------------------------------------------|----------------------------------------------------------------------------------------------------------------------------------------------------------------------------------------------------------------------------------------|----------------------------------------------------------------------------------------------------------|---------------------------------------------------------------------------------------------------------|
| <p><b>1</b>    <b>0823 1</b> cromo - <i>chrome</i> 50W<br/> <b>0824 1</b> cromo - <i>chrome</i> 100W<br/> <b>0826 1</b> cromo - <i>chrome</i> 200W<br/> <b>0827 1</b> cromo - <i>chrome</i> 300W<br/> <b>0849 1</b> cromo - <i>chrome</i> 400W</p> <p>Contenitore con trasformatore<br/> <i>Box with transformer</i></p> | <p><b>0823 5</b> bianco - <i>white</i> 50W<br/> <b>0824 5</b> bianco - <i>white</i> 100W<br/> <b>0826 5</b> bianco - <i>white</i> 200W<br/> <b>0827 5</b> bianco - <i>white</i> 300W<br/> <b>0849 5</b> bianco - <i>white</i> 400W</p> | <p><b>5</b>    <b>0203 1</b> cromo<br/> Staffa sostegno cavi<br/> <i>Twin support cables</i></p>         | <p><b>9</b>    <b>0340</b><br/> Coppia staffa sostegno<br/> <i>Pair of ceiling support brackets</i></p> |
| <p><b>2</b>    <b>0329 - 0319</b><br/> Cavo rame<br/> <i>Copper cable</i></p>                                                                                                                                                                                                                                            | <p><b>6</b>    <b>0208 1</b> cromo<br/> Coppia staffa sostegno<br/> + rinforzo<br/> <i>Couple support bracket<br/> + reinforcement</i></p>                                                                                             | <p><b>10</b>    <b>0341</b><br/> Coppia staffa sostegno<br/> <i>Pair of ceiling support brackets</i></p> |                                                                                                         |
| <p><b>3</b>    <b>0330 1</b> cromo<br/> Kit tendicavo<br/> <i>Jointed cable tightening kit</i></p>                                                                                                                                                                                                                       | <p><b>7</b>    <b>0336 1</b> cromo<br/> Kit per curva 45° a 120°<br/> <i>Kit for a curve from 45° to 120°</i></p>                                                                                                                      | <p><b>11</b>    <b>0339</b><br/> Coppia giunti isolante<br/> <i>Insulating joint couples</i></p>         |                                                                                                         |
| <p><b>4</b>    <b>0331 1</b> cromo<br/> Staffa sostegno soffitto<br/> <i>Ceiling support brackets</i></p>                                                                                                                                                                                                                | <p><b>8</b>    <b>0338 1</b> cromo<br/> Curva regolabile<br/> <i>Adjustable curve</i></p>                                                                                                                                              |                                                                                                          |                                                                                                         |

# FLIGHT SYSTEM

Design Athena

## ACCESSORI

	<p><b>0529 1</b> cromo - chrome Giunto flessibile. <i>Flexible joint.</i></p> <p> <b>33</b></p>		<p><b>0540 1</b> Coppia giunto isolante. <i>Two insulating connectors.</i></p> <p> <b>2</b></p>
	<p><b>0530 1</b> cromo - chrome (100 mm) <b>0531 1</b> cromo - chrome (50 mm) Coppia di tubi. <i>Couple of tubes.</i></p> <p> <b>266</b>    <b>133</b> <b>0530</b>   <b>0531</b></p>		<p><b>0541 1</b> cromo - chrome Supporto distanziale parete/soffitto. <i>Two distance support wall/ceiling.</i></p> <p> <b>66</b></p>
	<p><b>0532 1</b> cromo - chrome Coppia barre curve cm 100. <i>Two 100 cm curved bars.</i></p> <p> <b>258</b></p>		<p><b>0542 1</b> cromo - chrome Supporto curve 90° <i>90° curve connector</i></p> <p> <b>93</b></p>
	<p><b>0533 1</b> cromo - chrome Giunto orizzontale cm 20x20. <i>Horizontal joint cm 20x20.</i></p> <p> <b>90</b></p>		<p><b>0543 1</b> cromo - chrome Supporto a "T". <i>"T" Connector.</i></p> <p> <b>97</b></p>
	<p><b>0534 1</b> cromo - chrome Giunto verticale cm 20x20. <i>Vertical joint cm 20x20.</i></p> <p> <b>90</b></p>		<p><b>0544 5</b> trasparente - clear Coppia terminale per binario. <i>Two end-pieces for tracks.</i></p> <p> <b>4</b></p>
	<p><b>0535 1</b> cromo - chrome Coppia supporto per alimentazione. <i>Two electrical connectors.</i></p> <p> <b>90</b></p>		<p><b>0545 1</b> cromo - chrome Supporto a croce. <i>4-way connector.</i></p> <p> <b>105</b></p>
	<p><b>0539</b> Coppia giunto conduttore. <i>Two wire connectors.</i></p> <p> <b>4</b></p>		<p><b>0563 1</b> cromo - chrome Asta cm100 per discesa (per 0541). <i>100 cm vertical connecting rod (for 0541).</i></p> <p> <b>160</b></p>

# FLIGHT SYSTEM

Design Athena

Contenitore in metallo con trasformatore toroidale 230/12V

Box with toroidal transformer 230/12V

## ACCESSORI

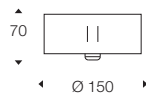

**0814 1** cromo - *chrome* (100 W)

**0814 7** grigio met - *metal grey* (100 W)

**0818 1** cromo - *chrome* (200 W)

**0818 7** grigio met - *metal grey* (200 W)

**0819 1** cromo - *chrome* (300 W)

**0819 7** grigio met - *metal grey* (300 W)

**0820 1** cromo - *chrome* (400 W)

**0820 7** grigio met - *metal grey* (400 W)

CE IP 20



1750

0814



2460

0818



3400

0819



4070

0820



# FLIGHT SYSTEM

Design Athena

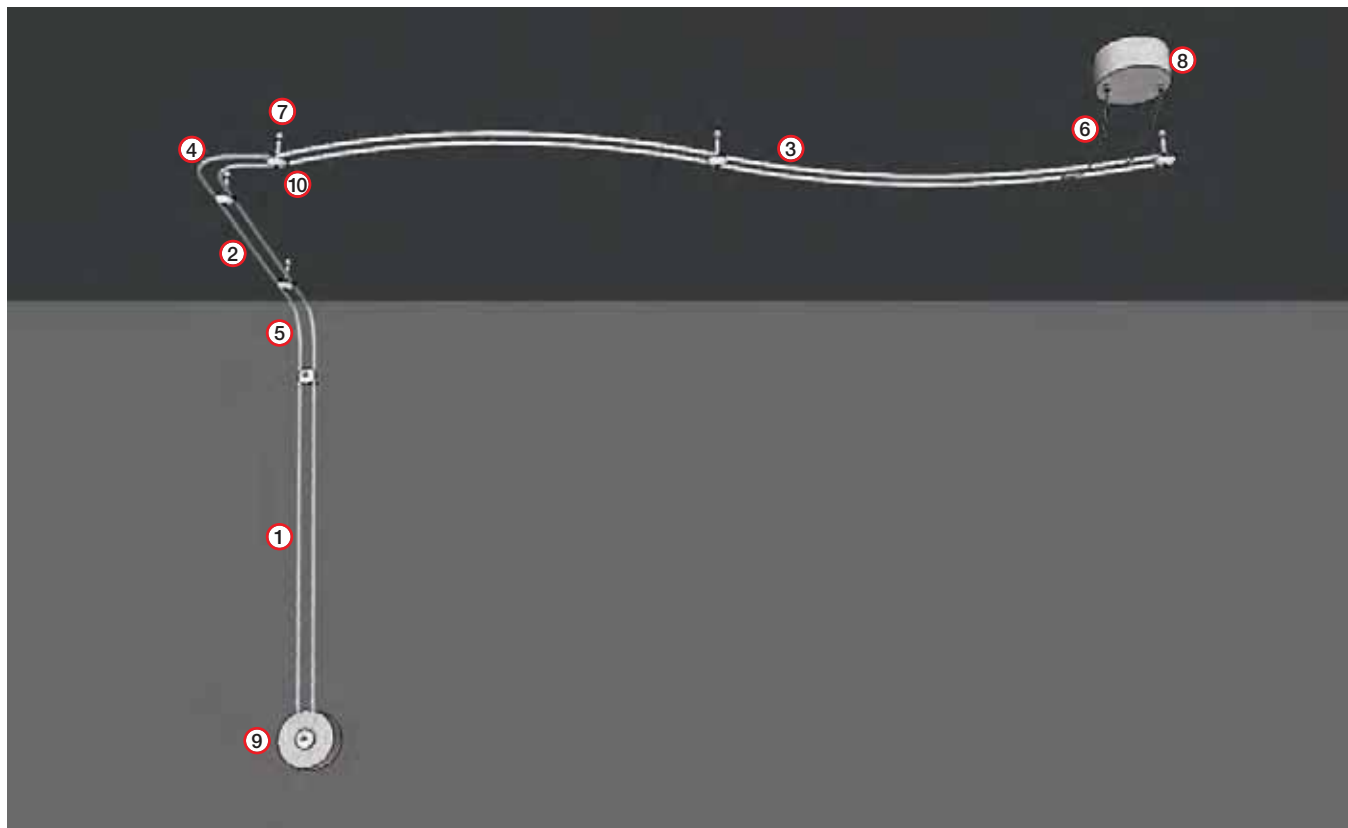

1 0530 cm 100

2 0531 cm 50  
Coppia di tubi  
*Couple of tubes*

5 0534

Giunto verticale  
*Vertical joint*

8 0823 50W Ø130  
0824 100W Ø130  
0826 200W Ø150  
0827 300W Ø150  
0849 400W Ø150

3 0532  
Coppia barre curve cm 100  
*Two 100 cm curved bars*

6 0535  
Coppia supporto per alimentazione  
*Two electrical connectors*

9 0814 100W  
0818 200W  
0819 300W  
0820 400W

4 0533  
Giunto orizzontale  
*Horizontal joint*

7 0541  
Supporto distanziale per parete/soffitto  
*Distance support for wall/ceiling*

10 0540  
Coppia giunto isolante  
*Two insulating connectors*

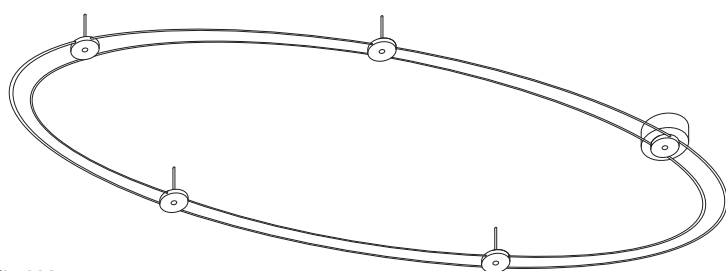

Ø 1600 mm  
Raggio: 800 mm  
Circonferenza: 5024 mm

## Composizioni cerchio - Ring configuration

Nr. 4 0541 Supporti - *Supports*

Nr. 5 0532 Barre curve - *curved bars*

Nr. 5 0539 Giunto conduttore - *Wire connectors*

Nr. 1 081... Contenitore con trasformatore - *Box with trafo*







104  
DADAJÈ



138  
MONET



162  
ALPHA



112  
PRISMA



144  
PICASSO



164  
BETA



114  
MILO



148  
RIFLESSI



166  
METAL



118  
GIOTTO



152  
KITE



168  
ARTE



124  
DEGAS



158  
MAGIC



172  
FARETTI



136  
MONDRIAN



160  
ONDA



# DADAJÈ

Design Athena

Collezione di applique LED da parete e plafone disponibili nelle finitura bianco, nero e grigio.

Collection of wall and ceiling LED lamps with white, black and grey finishing.

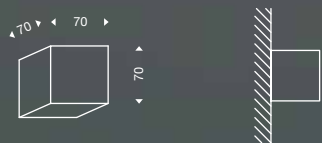
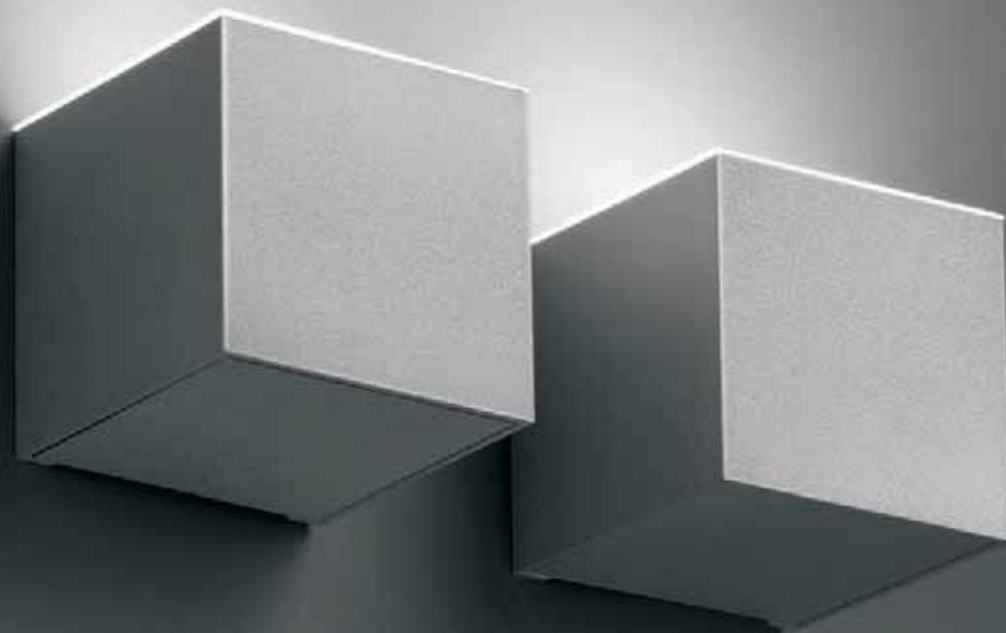

**520151** bianco NW - white

**520171** grigio NW - grey

**520191** nero NW - black

220/240V 8,7W Dimmable

Colori led - led colours

■ 1 Natural white  
4000°k 800lm

**520156** bianco WW - white

**520176** grigio WW - grey

**520196** nero WW - black

220/240V 8,7W Dimmable

Colori led - led colours

■ 6 Warm white  
3000°k 650lm



**530151** bianco NW - white

**530171** grigio NW - grey

**530191** nero NW - black

220/240V 13W Dimmable

Colori led - led colours

■ 1 Natural white  
4000°k 1210lm

**530156** bianco WW - white

**530176** grigio WW - grey

**530196** nero WW - black

220/240V 13W Dimmable

Colori led - led colours

■ 6 Warm white  
3000°k 1000lm

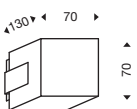

**526151** bianco NW - *white*  
**526171** grigio NW - *grey*  
**526191** nero NW - *black*  
 220/240V 8,7W Dimmable

Colori led - *led colours*

■ 1 Natural white  
 4000°k 800lm

**526156** bianco WW - *white*  
**526176** grigio WW - *grey*  
**526196** nero WW - *black*  
 220/240V 8,7W Dimmable

Colori led - *led colours*

■ 6 Warm white  
 3000°k 650lm

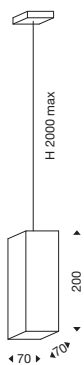

**540151** bianco NW - *white*

**540171** grigio NW - *grey*

**540191** nero NW - *black*

220/240V 8,7W Dimmable

Colori led - *led colours*

■ 1 Natural white  
4000°k 800lm

**540156** bianco WW - *white*

**540176** grigio WW - *grey*

**540196** nero WW - *black*

220/240V 8,7W Dimmable

Colori led - *led colours*

■ 6 Warm white  
3000°k 650lm

CE IP 40    LED CRI >80 

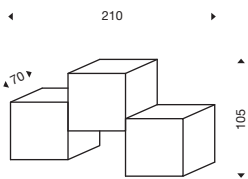

**523151** bianco NW - *white*  
**523171** grigio NW - *grey*  
**523191** nero NW - *black*  
 220/240V 26W Dimmable

Colori led - *led colours*

■ 1 Natural white  
 4000°k 2400lm

**523156** bianco WW - *white*  
**523176** grigio WW - *grey*  
**523196** nero WW - *black*  
 220/240V 26W Dimmable

Colori led - *led colours*

■ 6 Warm white  
 3000°k 1950lm

LED CRI >80 **A**

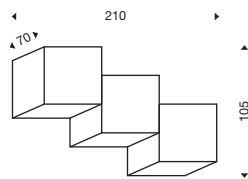

**524151** bianco NW - *white*  
**524171** grigio NW - *grey*  
**524191** nero NW - *black*  
 220/240V 26W Dimmable

Colori led - *led colours*

■ 1 Natural white  
 4000°k 2400lm

**524156** bianco WW - *white*  
**524176** grigio WW - *grey*  
**524196** nero WW - *black*  
 220/240V 26W Dimmable

Colori led - *led colours*

■ 6 Warm white  
 3000°k 1950lm

LED CRI >80 **A**

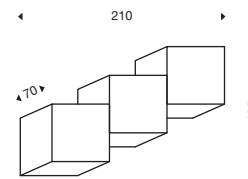

**525151** bianco NW - *white*  
**525171** grigio NW - *grey*  
**525191** nero NW - *black*  
 220/240V 26W Dimmable

Colori led - *led colours*

■ 1 Natural white  
 4000°k 2400lm

**525156** bianco WW - *white*  
**525176** grigio WW - *grey*  
**525196** nero WW - *black*  
 220/240V 26W Dimmable

Colori led - *led colours*

■ 6 Warm white  
 3000°k 1950lm

LED CRI >80 **A**



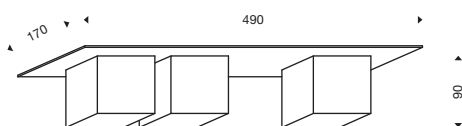
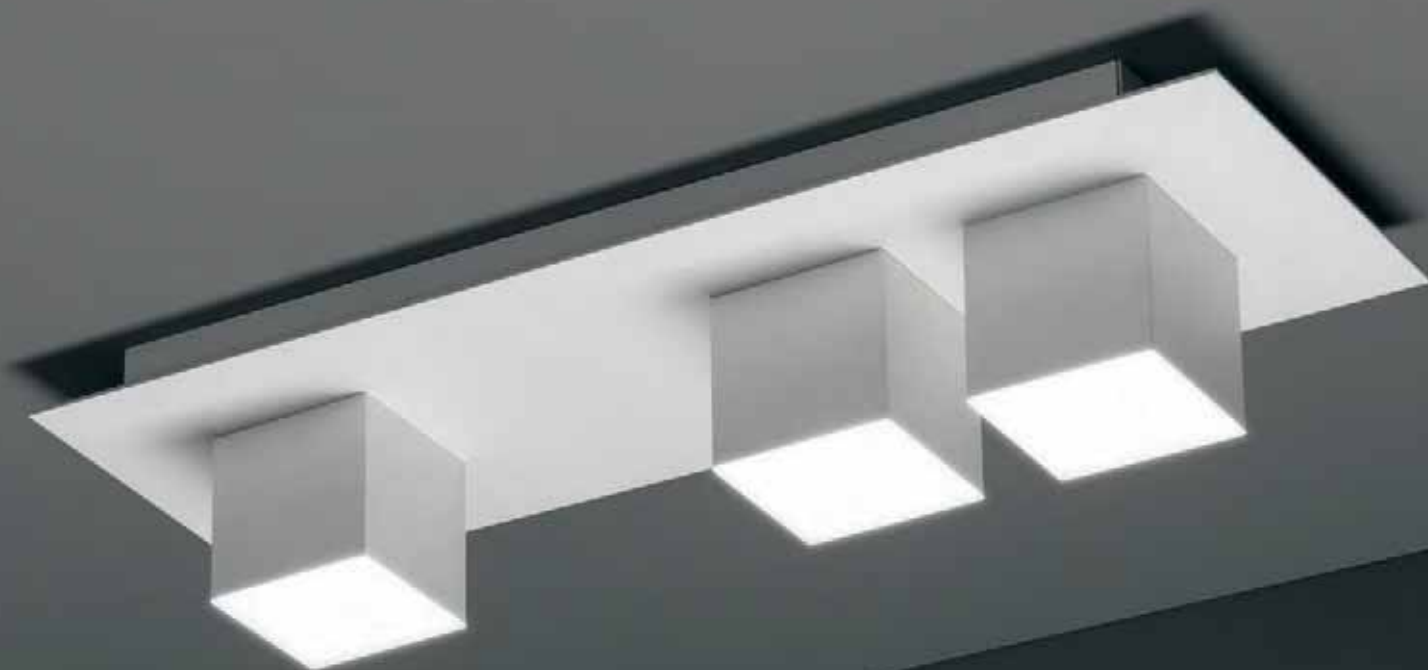

**527151** bianco NW - *white*

**527171** grigio NW - *grey*

**527191** nero NW - *black*

220/240V 26W *Dimmable*

Colori led - *led colours*

■ 1 Natural white  
4000°k 2400lm

**527156** bianco WW - *white*

**527176** grigio WW - *grey*

**527196** nero WW - *black*

220/240V 26W *Dimmable*

Colori led - *led colours*

■ 6 Warm white  
3000°k 1950lm

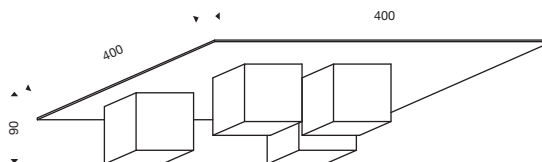

**528151** bianco NW - *white*

**528171** grigio NW - *grey*

**528191** nero NW - *black*

220/240V 35W *Dimmable*

Colori led - *led colours*

■ 1 Natural white  
4000°k 3200lm

**528156** bianco WW - *white*

**528176** grigio WW - *grey*

**528196** nero WW - *black*

220/240V 35W *Dimmable*

Colori led - *led colours*

■ 6 Warm white  
3000°k 2600lm



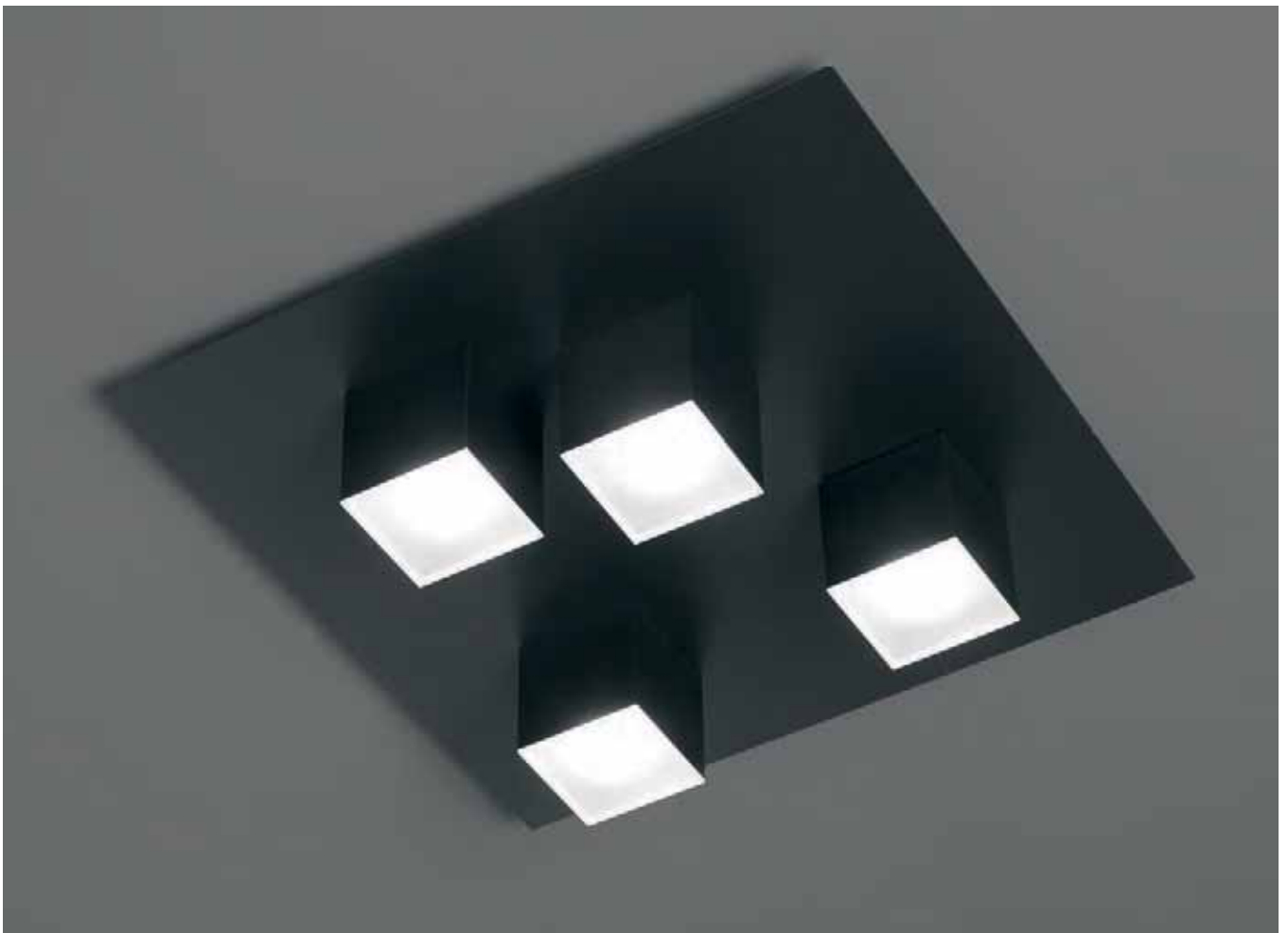

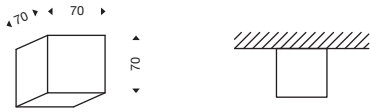

**529151** bianco NW - white

**529171** grigio NW - grey

**529191** nero NW - black

220/240V 8,7W Dimmable

Colori led - led colours

- 1 Natural white  
4000°k 800lm

**529156** bianco WW - white

**529176** grigio WW - grey

**529196** nero WW - black

220/240V 8,7W Dimmable

Colori led - led colours

- 6 Warm white  
3000°k 650lm

CE IP 40    LED CRI >80 

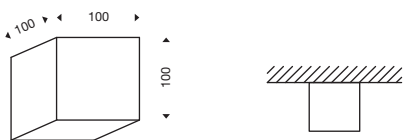

**539151** bianco NW - white

**539171** grigio NW - grey

**539191** nero NW - black

220/240V 13W Dimmable

Colori led - led colours

- 1 Natural white  
4000°k 1210lm

**539156** bianco WW - white

**539176** grigio WW - grey

**539196** nero WW - black

220/240V 13W Dimmable

Colori led - led colours

- 6 Warm white  
3000°k 1000lm

CE IP 40    LED CRI >80 





# PRISMA

Design Athena

Collezione di applique LED da parete e plafone disponibili nelle finitura bianco, nero e grigio.

Collection of wall and ceiling LED lamps with white, black and grey finishing.

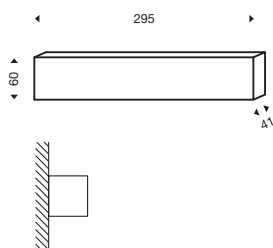
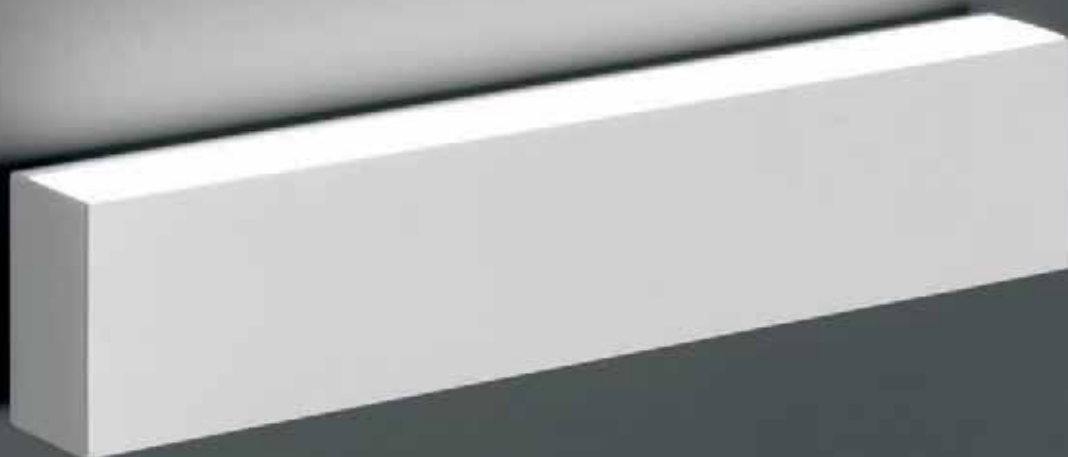

**550151** bianco NW - white  
**550171** grigio NW - grey  
**550191** nero NW - black  
 LED 11W - Driver incluso - Driver included

Colori led - led colours

■ 1 Natural white  
 4000°k 1450lm

**550156** bianco WW - white  
**550176** grigio WW - grey  
**550196** nero WW - black  
 LED 11W - Driver incluso - Driver included

Colori led - led colours

■ 6 Warm white  
 3000°k 1350lm

LED CRI >80 **A++**  
 CE IP 40     

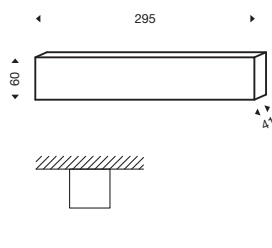

**559151** bianco NW - white  
**559171** grigio NW - grey  
**559191** nero NW - black  
 LED 11W - Driver incluso - Driver included

Colori led - led colours

■ 1 Natural white  
 4000°k 1450lm

**559156** bianco WW - white  
**559176** grigio WW - grey  
**559196** nero WW - black  
 LED 11W - Driver incluso - Driver included

Colori led - led colours

■ 6 Warm white  
 3000°k 1350lm

LED CRI >80 **A++**  
 CE IP 40     

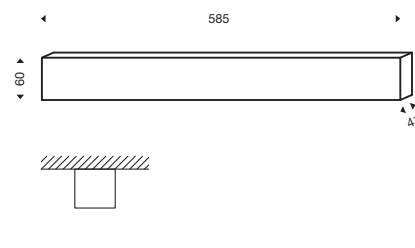

**569151** bianco NW - white  
**569171** grigio NW - grey  
**569191** nero NW - black  
 LED 22W - Driver incluso - Driver included

Colori led - led colours

■ 1 Natural white  
 4000°k 2900lm

**569156** bianco WW - white  
**569176** grigio WW - grey  
**569196** nero WW - black  
 LED 22W - Driver incluso - Driver included

Colori led - led colours

■ 6 Warm white  
 3000°k 2700lm

LED CRI >80 **A++**  
 CE IP 40     



# MILO

*Design Athena*

Collezione di applique LED da parete e plafone disponibili nelle finitura bianco.

*Collection of wall and ceiling LED lamps, white finishing.*



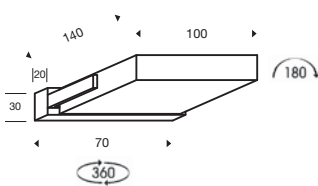

**560151** bianco NW - white  
220/240V 8,7W Dimmable

Colori led - led colours

- 1 Natural white  
4000°k 800lm

**560156** bianco WW - white  
220/240V 8,7W Dimmable

Colori led - led colours

- 6 Warm white  
3000°k 650lm

Colori policarbonato - Polycarbonate colours

- 1 Trasparente - Transparent
- 2 Blu - Blue
- 6 Giallo - Yellow
- 7 Arancio - Orange
- 8 Rosso - Red

LED CRI >80 **A**

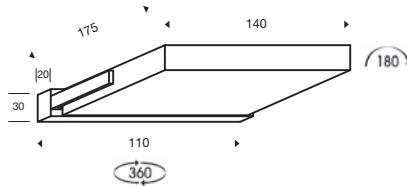

**570151** bianco NW - white  
220/240V 13W Dimmable

Colori led - led colours

- 1 Natural white  
4000°k 1210lm

**570156** bianco WW - white  
220/240V 13W Dimmable

Colori led - led colours

- 6 Warm white  
3000°k 1000lm

Colori policarbonato - Polycarbonate colours

- 1 Trasparente - Transparent
- 2 Blu - Blue
- 6 Giallo - Yellow
- 7 Arancio - Orange
- 8 Rosso - Red

LED CRI >80 **A**



In fase d'ordine specificare colore policarbonato:  
Es 570151 2 = bianco NW blu  
Specify polyc. colour when ordering:  
IP Es 570151 2 = white NW blue

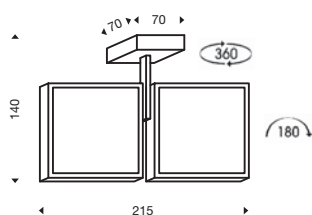

**562151** bianco NW - white

220/240V 17,4W Dimmable

Colori led - led colours

■ 1 Natural white  
4000°k 1600lm

**562156** bianco WW - white

220/240V 17,4W Dimmable

Colori led - led colours

■ 6 Warm white  
3000°k 1300lm

Colori policarbonato - Polycarbonate colours

□ 1 Trasparente - Transparent

■ 2 Blu - Blue

■ 7 Arancio - Orange

■ 6 Giallo - Yellow

■ 8 Rosso - Red

LED CRI >80 **A**

CE IP 40    520

In fase d'ordine specificare

colore policarbonato:

Es 570151 2 = bianco NW blu

Specify polyc. colour when ordering:

IP Es 570151 2 = white NW blue

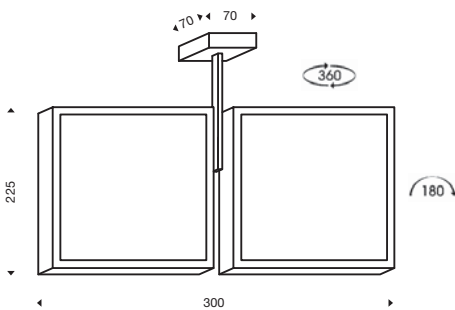

**572151** bianco NW - white

220/240V 26W Dimmable

Colori led - led colours

■ 1 Natural white  
4000°k 2420lm

**572156** bianco WW - white

220/240V 26W Dimmable

Colori led - led colours

■ 6 Warm white  
3000°k 2000lm

Colori policarbonato - Polycarbonate colours

□ 1 Trasparente - Transparent

■ 2 Blu - Blue

■ 7 Arancio - Orange

■ 6 Giallo - Yellow

■ 8 Rosso - Red

LED CRI >80 **A**

CE IP 40   

In fase d'ordine specificare  
colore policarbonato:  
Es 570151 2 = bianco NW blu

Specify polyc. colour when ordering:  
IP Es 570151 2 = white NW blue

# GIOTTO

Design Athena

Serie di sospensioni circolari combinabili tra loro, realizzate in alluminio con finitura bianca e montate con led da 14,4 o 19,2 w/m. Luce naturale, calda o RGB. Le sospensioni devono essere completate con il contenitore con l'alimentatore.

*Circular suspensions combined together, made of white painted aluminium and fitted with 14,4 or 19,2 w/mt strip LED natural, warm or RGB.*

*Suspensions have to be completed with its appropriate box with driver.*

## ESEMPIO DI COMPOSIZIONI

Gli elementi a sospensione, di qualsiasi dimensione, possono essere combinati tra loro in base alle proprie esigenze.

*EXAMPLE OF COMPOSITIONS*

*Suspensions, of any size, can be combined together to suit your needs*

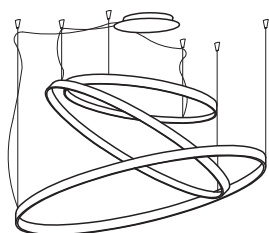

**Sospensione a 3 cerchi, 69,8w totale, con scatola alimentazione NON dimmerabile:**

*Suspensions composed by 3 circles lamps, 69,8w, with NON-dimmable power supply:*

**775114 5** - sospensione tonda diametro 390 mm

**775214 5** - sospensione tonda diametro 520 mm

**775314 5** - sospensione tonda diametro 640 mm

**1264 5** - contenitore con alimentatore max 75w

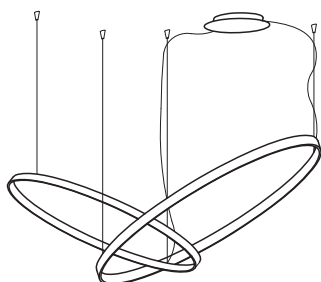

**Sospensione a 2 cerchi, 40,8w totale, con scatola alimentazione dimmerabile push:**

*Suspensions composed by 2 circles lamps, 40,8w, with dimmable power supply:*

**775114 5** - sospensione tonda diametro 390 mm

**775214 5** - sospensione tonda diametro 520 mm

**1264D 5** - contenitore con alimentatore max 75w dimmerabile con push



Realizzazione effettuata da Campolux - Campoligure





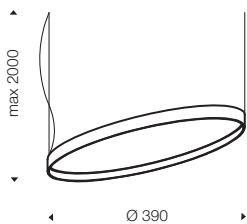

**775114 5** bianco - white

Cerchio  
Led = 17,4 w

Colori led - led colours

- 1 Natural white 4000-4500°K 1340 lm
- 6 Warm white 2800-3300°K 1305 lm
- 9 RGB

**775119 5** bianco - white

Cerchio  
Led = 23,10 w

Colori led - led colours

- 1 Natural white 4000-4500°K 1900 lm
- 6 Warm white 2800-3300°K 1850 lm

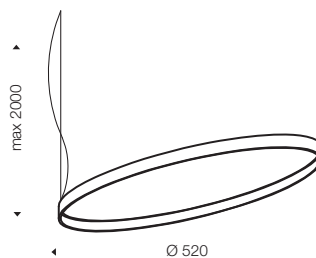

**775214 5** bianco - white

Cerchio  
Led = 23,4 w

Colori led - led colours

- 1 Natural white 4000-4500°K 1803 lm
- 6 Warm white 2800-3300°K 1750 lm
- 9 RGB

**775219 5** bianco - white

Cerchio  
Led = 30,70 w

Colori led - led colours

- 1 Natural white 4000-4500°K 2530 lm
- 6 Warm white 2800-3300°K 2460 lm



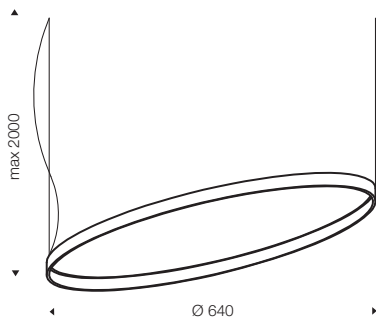

**775314 5** bianco - white

Cerchio  
Led = 29 w

Colori led - led colours

- 1 Natural white 4000-4500°K 2200 lm
- 6 Warm white 2800-3300°K 2160 lm
- 9 RGB

**775319 5** bianco - white

Cerchio  
Led = 38,40 w

Colori led - led colours

- 1 Natural white 4000-4500°K 3160 lm
- 6 Warm white 2800-3300°K 3080 lm

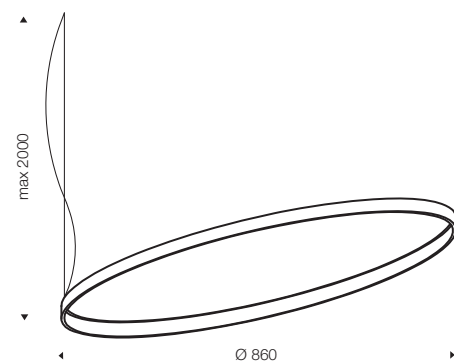

**775414 5** bianco - white

Cerchio  
Led = 38,8 w

Colori led - led colours

- 1 Natural white 4000-4500°K 2990 lm
- 6 Warm white 2800-3300°K 2900 lm
- 9 RGB

**775419 5** bianco - white

Cerchio  
Led = 51,50 w

Colori led - led colours

- 1 Natural white 4000-4500°K 4230 lm
- 6 Warm white 2800-3300°K 4130 lm







Showroom Moose Design Resine

## ACCESSORI GIOTTO



24v max 75w

**1264 5** bianco - white

**1264D 5** bianco - white  
DIMMERABILE push

**1264R 5** bianco - white  
RGB push

Contenitore in metallo con alimentatore 24V max 75W con 3 fori per entrata cavi, disponibile anche nella versione Dimmerabile o RGB  
Metal box with driver 24V max 75W with 3 holes for cables, available also with DIMMER or RGB.



24v max 150w

**1265 5** bianco - white

**1265D 5** bianco - white  
DIMMERABILE push

**1265R 5** bianco - white  
RGB push

Contenitore in metallo con alimentatore 24V max 150W con 3 fori per entrata cavi, disponibile anche nella versione Dimmerabile o RGB  
Metal box with driver 24V max 150W with 3 holes for cables, available also with DIMMER or RGB.



# DEGAS

Design Athena

Serie di sospensioni a LED, realizzate in alluminio con finitura bianca, nera e alluminio anodizzato. Montate con strip led 19,2w NON dimmerabile. Scatola alimentazione inclusa.

Series of suspensions lamps LED, made of aluminum with white, black and anodized aluminum finishing. Assembled with 19.2w NOT dimmable LED strip. Power Supply included.

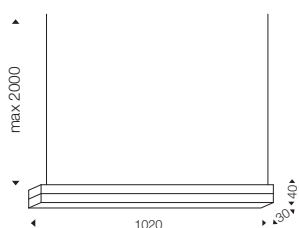

**905119 5** bianco - white

**905119 7** grigio - grey

**905119 9** nero - black

led 19,2w (lm NW 1580 WW 1540) up

led 38,4w (lm NW 3160 WW 3080) down

Colori led - led colours

■ 1 Natural white 4000-4500°K ■ 6 Warm white 2800-3300°K

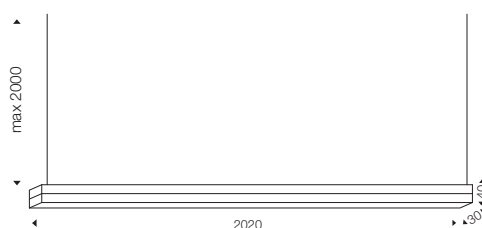

**905419 5** bianco - white

**905419 7** grigio - grey

**905419 9** nero - black

led 38,4w (lm NW 3160 WW 3080) up

led 76,8w (lm NW 6320 WW 6160) down

Colori led - led colours

■ 1 Natural white 4000-4500°K ■ 6 Warm white 2800-3300°K



Dimmerabile su richiesta  
Dimmerable on demand.

Driver incluso.  
Driver included.



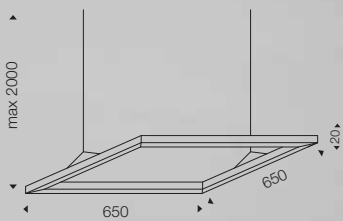

**905219 5** bianco - *white*

**905219 7** grigio - *grey*

**905219 9** nero - *black*

led 19,2w/m = 48 w  
(lm NW 3950 WW 3850)

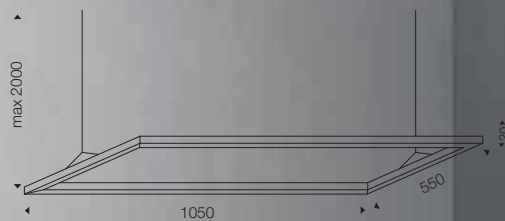

**905319 5** bianco - *white*

**905319 7** grigio - *grey*

**905319 9** nero - *black*

led 19,2w/m = 60 w  
(lm NW 4930 WW 4800)

Colori led - *led colours*

■ 1 Natural white 4000-4500°K ■ 6 Warm white 2800-3300°K

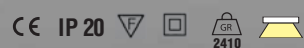

Colori led - *led colours*

■ 1 Natural white 4000-4500°K ■ 6 Warm white 2800-3300°K



Dimmerabile su richiesta  
*Dimmerable on demand.*

Driver incluso.  
*Driver included.*







Realizzazione effettuata da Traiano Luce - Torino

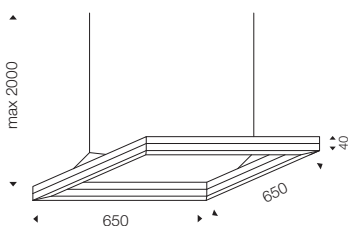

**905519 5** bianco - *white*

**905519 7** grigio - *grey*

**905519 9** nero - *black*

led 24w lm NW 2050 WW 2000 up

led 48w lm NW 3950 WW 3800 down

Colori led - *led colours*

■ 1 Natural white 4000-4500°K    ■ 6 Warm white 2800-3300°K



Dimmerabile su richiesta  
*Dimmerable on demand.*

Driver incluso.  
*Driver included.*

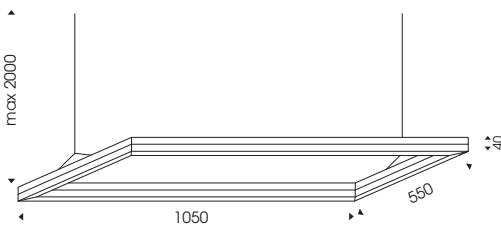

905619 5 bianco - *white*

905619 7 grigio - *grey*

905619 9 nero - *black*

led 39w lm NW 3160 WW 3080 up

led 60w lm NW 4930 WW 4800 down

Colori led - *led colours*

1 Natural white 4000-4500°K

6 Warm white 2800-3300°K

Dimmerabile su richiesta

*Dimmerable on demand.*



Driver incluso.

*Driver included.*

# DEGAS

Design Athena

Serie di lampade da terra e a parete a LED, dimmerabili, con varie potenze. Adatte per ambienti vari quali spazi espositivi, sale conferenze, uffici, abitazioni ed altri.

Series of LED floor lamps with dimmer and different powers. Dimmable power supply included Suitable for various type of spaces as exhibition areas, conference rooms, offices, domestic and wall environments and other.



#### DIMMER

pressione breve: accende/spegne  
pressione lunga: regola

*DIMMER:*  
quick pressure: switch on/off  
long pressure: dimmer

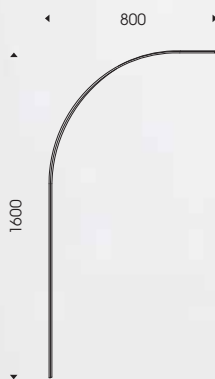

**908119 5** bianco - white

**908119 7** grigio - grey

**908119 9** nero - black

*DIMMERABILE*

**Led = 38,4w**

Colori led - led colours

1 Natural white 4000-4500°K 3160 lm	6 Warm white 2800-3300°K 3080 lm
-------------------------------------------	----------------------------------------

Driver incluso.  
Driver included.



**908019 5** bianco - white

**908019 7** grigio - grey

**908019 9** nero - black

**Led = 48w**

Colori led - led colours

1 Natural white 4000-4500°K 3950 lm	6 Warm white 2800-3300°K 3450 lm
-------------------------------------------	----------------------------------------







**Art. 908219**  
**Doppia accensione.**  
**Regolazione di intensità luminosa di entrambi i**  
**lati indipendenti.**

*Double switch.*  
*Adjustment of light intensity of both sides independent.*



**Art. 908319**  
**Doppia accensione.**  
**Regolazione di intensità luminosa da un lato.**  
**Gestioni luci RGB dall'altro lato.**

*Double switch.*  
*Adjustment of light intensity on one side.*  
*RGB lights on other side.*



# DEGAS

Design Athena

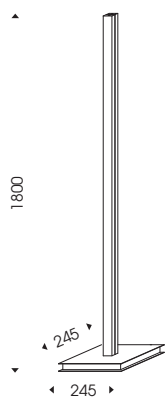

Doppia accensione.  
Regolazione di intensità luminosa di entrambi i lati indipendenti.  
*Double switch.  
Adjustment of light intensity of both sides independent.*

908219 5 bianco - white

908219 7 grigio - grey

908219 9 nero - black

**Led = 57,6w per lato**  
DIMMERABILE

Colori led - led colours

■ 1 Natural white 4000-4500°K 9480 lm	■ 6 Warm white 2800-3300°K 9240 lm
---------------------------------------------	------------------------------------------

CE IP 20     
7580

**DIMMERABILE + RGB**

908319 5 bianco - white

908319 7 grigio - grey

908319 9 nero - black

**Led = 57,6w + RGB**  
DIMMERABILE + RGB

Colori led - led colours

■ 0 Natural white+RGB 4000-4500°K (NW) 4740 lm NW+RGB	■ 3 Warm white+RGB 2800-3300°K (WW) 4620 lm WW+RGB
-------------------------------------------------------------	----------------------------------------------------------

CE IP 20     
7580

Driver incluso.  
*Driver included.*







# MONDRIAN

*Design Athena*



A richiesta realizzazioni con misure personalizzate  
*Customed sizes on demand*

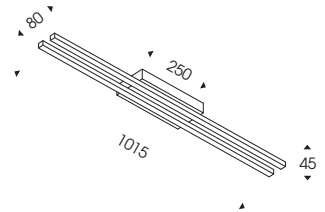

**8732 5** bianco - *white*

**8732 7** grigio - *grey*

**8732 9** nero - *black*

38,4w strip 2x240led  
lm NW 3160 WW 3080

Colori led - *led colours*

■ 1 Natural white 4000-4500°K    ■ 6 Warm white 2800-3200°K

CE IP 20    1000

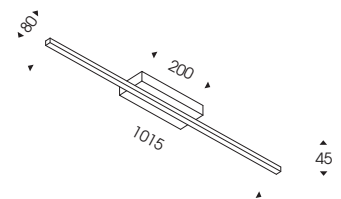

**8731 5** bianco - *white*

**8731 7** grigio - *grey*

**8731 9** nero - *black*

19,2w strip 240led  
lm NW 1580 WW 1540

Colori led - *led colours*

■ 1 Natural white 4000-4500°K    ■ 6 Warm white 2800-3200°K

CE IP 20    800

Driver incluso.  
*Driver included.*

# MONET

*Design Athena*

Collezione di plafoniere e sospensioni realizzate in PMMA lucido nella versione bianco e nero con punti luci led da 4,2W cadauno. La collezione è disponibile anche nella versione con dimmer con funzione di accensione, spegnimento e regolazione tramite push.

*Collection of ceiling lamps and suspensions made by glossy PMMA. Available in white and black colour and spotted by 4,2w leds. The collection is also available with dimmer push controller.*





# MONET

Design Athena

## Art. 1299

Accessorio per dimmerazione e per l'ordine della sospensione completa di accessorio di dimmerazione (max 50W)

Richiedere: COD SOSP: + 1299 (es: 8954 + 1299)

To order suspension with dimmer ask: SUSP. CODE + 1299 (es: 8954 + 1299)

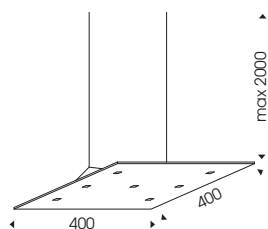

**8954 5** bianco - white

**8954 9** nero - black

LED DIMMERABILI

5 led x 4,2w

Colori led - led colours

■ 1 Natural white 4000°K 2300 lm  
■ 6 Warm white 3000°K 2150 lm



LED CRI >80 **A**

**8974 5** bianco - white

**8974 9** nero - black

con LUCE SUPERIORE

Predisposta per doppia accensione

5 led x 4,2w + 1 led 13w

Colori led - led colours

■ 1 Natural white 4000°K 2300 lm + 1000 lm  
■ 6 Warm white 3000°K 2150 lm + 940 lm



LED CRI >80 **A**

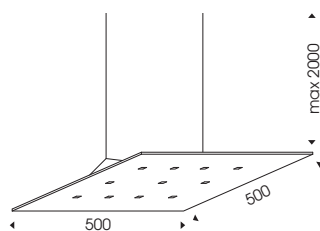

**8955 5** bianco - white

**8955 9** nero - black

LED DIMMERABILI

9 led x 4,2w

Colori led - led colours

■ 1 Natural white 4000°K 4200 lm  
■ 6 Warm white 3000°K 3900 lm



LED CRI >80 **A**

**8975 5** bianco - white

**8975 9** nero - black

con LUCE SUPERIORE

Predisposta per doppia accensione

9 led x 4,2w + 1 led 13w

Colori led - led colours

■ 1 Natural white 4000°K 4200 lm + 1000 lm  
■ 6 Warm white 3000°K 3900 lm + 940 lm



LED CRI >80 **A**

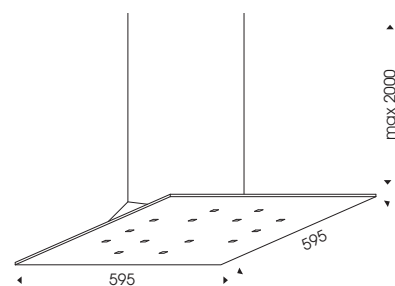

**8956 5** bianco - white

**8956 9** nero - black

LED DIMMERABILI

12 led x 4,2w

Colori led - led colours

■ 1 Natural white 4000°K 5500 lm  
■ 6 Warm white 3000°K 5100 lm



LED CRI >80 **A**

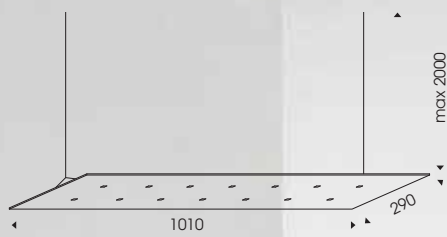

**8976 5** bianco - *white*

**8976 9** nero - *black*

con LUCE SUPERIORE

Predisposta per doppia accensione

12 led x 4,2w + 1 led 13w

Colori led - *led colours*

1 Natural white  
4000°K  
5500 lm + 1000 lm

6 Warm white  
3000°K  
5100 lm + 940 lm



LED CRI >80 **A**

**8957 5** bianco - *white*

**8957 9** nero - *black*

LED DIMMERABILI

10 led x 4,2w

Colori led - *led colours*

1 Natural white  
4000°K  
4800 lm

6 Warm white  
3000°K  
4300 lm



LED CRI >80 **A**

**8977 5** bianco - *white*

**8977 9** nero - *black*

con LUCE SUPERIORE

Predisposta per doppia accensione

10 led x 4,2w + 1 led 13w

Colori led - *led colours*

1 Natural white  
4000°K  
4800 lm + 1000 lm

6 Warm white  
3000°K  
4300 lm  
+ 940 lm



LED CRI >80 **A**

## MONET

Design Athena



## Art. 1299

Accessorio per dimmerazione e per l'ordine della plafoniera completa di accessorio di dimmerazione (max 50W)  
 Richiedere: COD SOSP: + 1299 (es: 8954 + 1299)

To order ceiling fixtures with dimmer ask: SUSP. CODE + 1299 (es: 8954 + 1299)

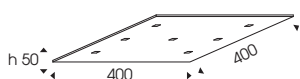

**8944 5** bianco - white  
**8944 9** nero - black

LED DIMMERABILI

5 led x 4,2w

Colori led - led colours

■ 1 Natural white 4000°K 2300 lm  
 ■ 6 Warm white 3000°K 2150 lm

CE IP 20 F ⊕ GR 2100

LED CRI &gt;80 A

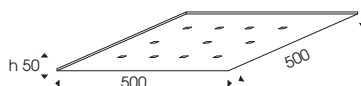

**8945 5** bianco - white  
**8945 9** nero - black

LED DIMMERABILI

9 led x 4,2w

Colori led - led colours

■ 1 Natural white 4000°K 4200 lm  
 ■ 6 Warm white 3000°K 3900 lm

CE IP 20 F ⊕ GR 2900

LED CRI &gt;80 A

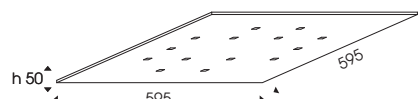

**8946 5** bianco - white  
**8946 9** nero - black

LED DIMMERABILI

12 led x 4,2w

Colori led - led colours

■ 1 Natural white 4000°K 5500 lm  
 ■ 6 Warm white 3000°K 5100 lm

CE IP 20 F ⊕ GR 4600

LED CRI &gt;80 A

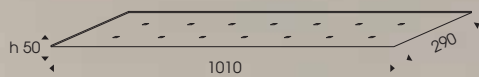

**8947 5** bianco - *white*

**8947 9** nero - *black*

LED DIMMERABILI

10 led x 4,2w

Colori led - *led colours*

■ 1 Natural white	■ 6 Warm white
4000°K	3000°K
4800 lm	4300 lm

CE IP 20   

LED CRI >80 



# PICASSO

*Design Athena*

Collezione di applique disponibili in 3 misure con biemissione o monoemissione. La vasta gamma di colori della collezione ne permette l'utilizzo in ambienti commerciali, lavorativi e domestici e in contesti sia moderni che classici

*Collection of wall lamp available in 3 sizes with bidirectional or unidirectional light. The wide range of colors of the collection allows the use in commercial, business and domestic contexts in both modern and classic.*



Finiture colori:

*Colours:*



1 cromo  
*chrome*



2 satinato  
*nikel*



5 bianco  
*white*

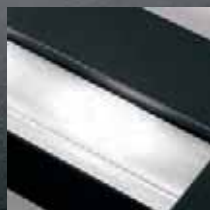

9 nero  
*black*

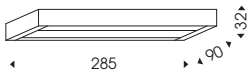

**88611 1** cromo - *chrome*

**88611 2** satinato - *nikel*

**88611 5** bianco - *white*

**88611 9** nero - *black*

3 led x 4,2w

Colori led - *led colours*

■ 1 Natural white 4000°K 1560 lm  
 ■ 6 Warm white 3000°K 1440 lm



LED CRI >80 **A**

**88612 1** cromo - *chrome*

**88612 2** satinato - *nikel*

**88612 5** bianco - *white*

**88612 9** nero - *black*

3 led x 4,2w (lm NW 1560 WW 1440)  
 1 led x 4,2w (lm NW 520 WW 480)

Colori led - *led colours*

■ 1 Natural white 4000°K  
 ■ 6 Warm white 3000°K



LED CRI >80 **A**

Driver incluso.  
*Driver included.*

# PICASSO

Design Athena



Realizzazione effettuata da Coop Sei - Dro

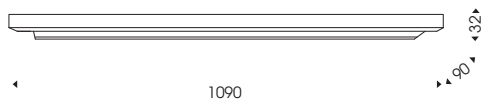

**8863119 1** cromo - *chrome*

**8863119 2** satinato - *nikel*

**8863119 5** bianco - *white*

**8863119 9** nero - *black*

1 x 19,2W 240 led

Colori led - *led colours*

■ 1 Natural white	■ 6 Warm white
4000-4500°K	2800-3200°K
1580 lm	1540 lm

**8863219 1** cromo - *chrome*

**8863219 2** satinato - *nikel*

**8863219 5** bianco - *white*

**8863219 9** nero - *black*

2 x 19,2W 240 led

Colori led - *led colours*

■ 1 Natural white	■ 6 Warm white
4000-4500°K	2800-3200°K
3160 lm	3080 lm

# PICASSO

Design Athena



Realizzazione effettuata da La Luce di Zonch - Buttrio

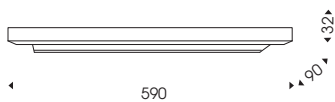

**8862119 1** cromo - *chrome*

**8862119 2** satinato - *nikel*

**8862119 5** bianco - *white*

**8862119 9** nero - *black*

1 x 9,6W 120 led

Colori led - *led colours*

■ 1 Natural white 4000-4500°K 790 lm  
 ■ 6 Warm white 2800-3200°K 770 lm

**8862219 1** cromo - *chrome*

**8862219 2** satinato - *nikel*

**8862219 5** bianco - *white*

**8862219 9** nero - *black*

2 x 9,6W 120 led

Colori led - *led colours*

■ 1 Natural white 4000-4500°K 1580 lm  
 ■ 6 Warm white 2800-3200°K 1540 lm



Driver incluso.  
 Driver included.

## RIFLESSI

*Design Athena*

Collezione di plafoniere con vetro quadrato extra-chiaro. Il vetro è sabbiato da entrambe le parti e trasparente nel riquadro centrale. Il riquadro centrale viene messo in risalto dagli inserti in vetro e dal fondo in alluminio a specchio. Prodotto nella versione LED da 4,8 W o 9,6 W.

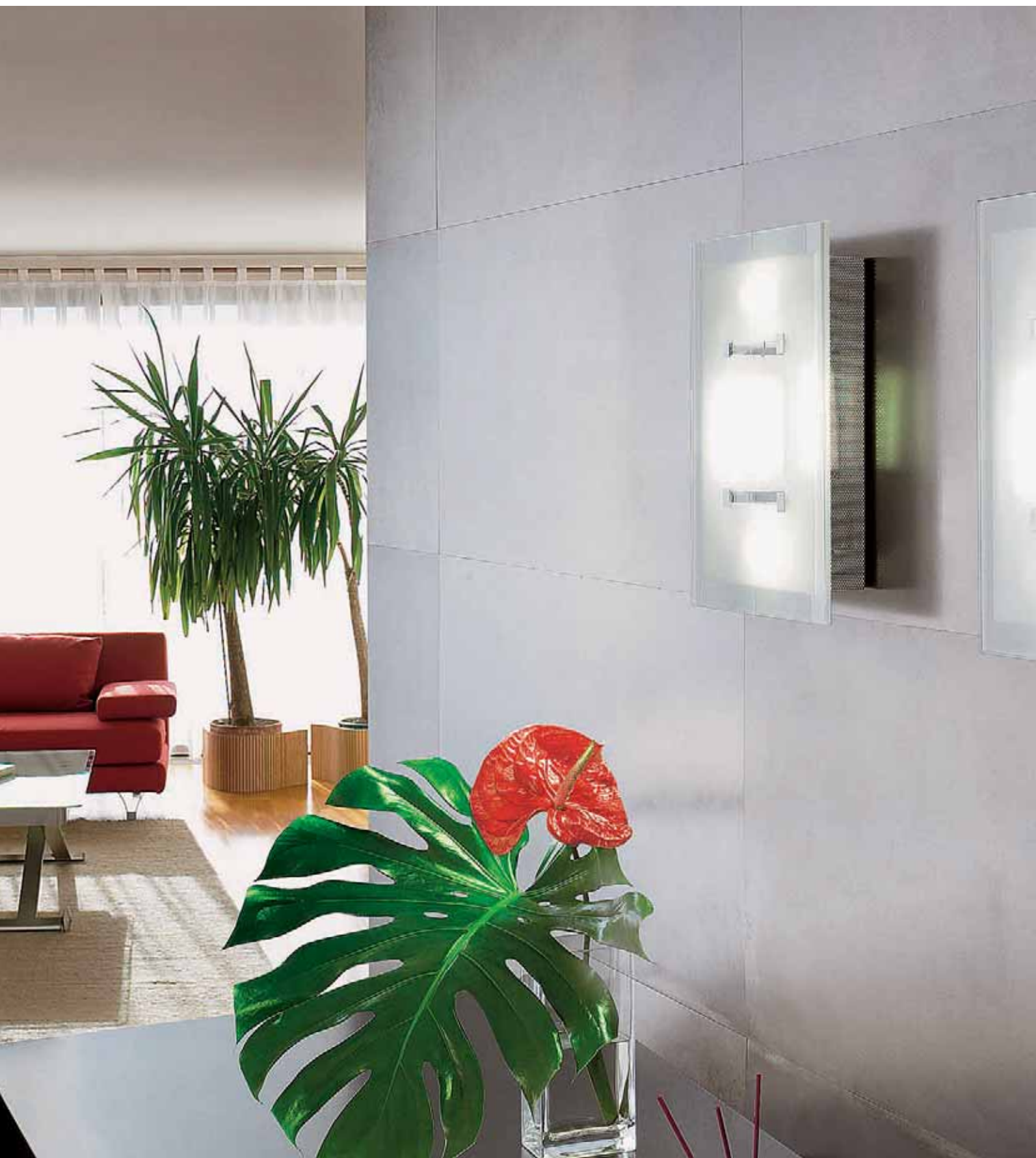

*A collection of ceiling light fixtures with extra-clear square glass. The glass is sanded on both sides and is transparent in the central panel. The central panel is put into relief by the glass inserts and by the aluminium back which is like a mirror. It comes in the version 4,8 W or 9,6 W LED.*



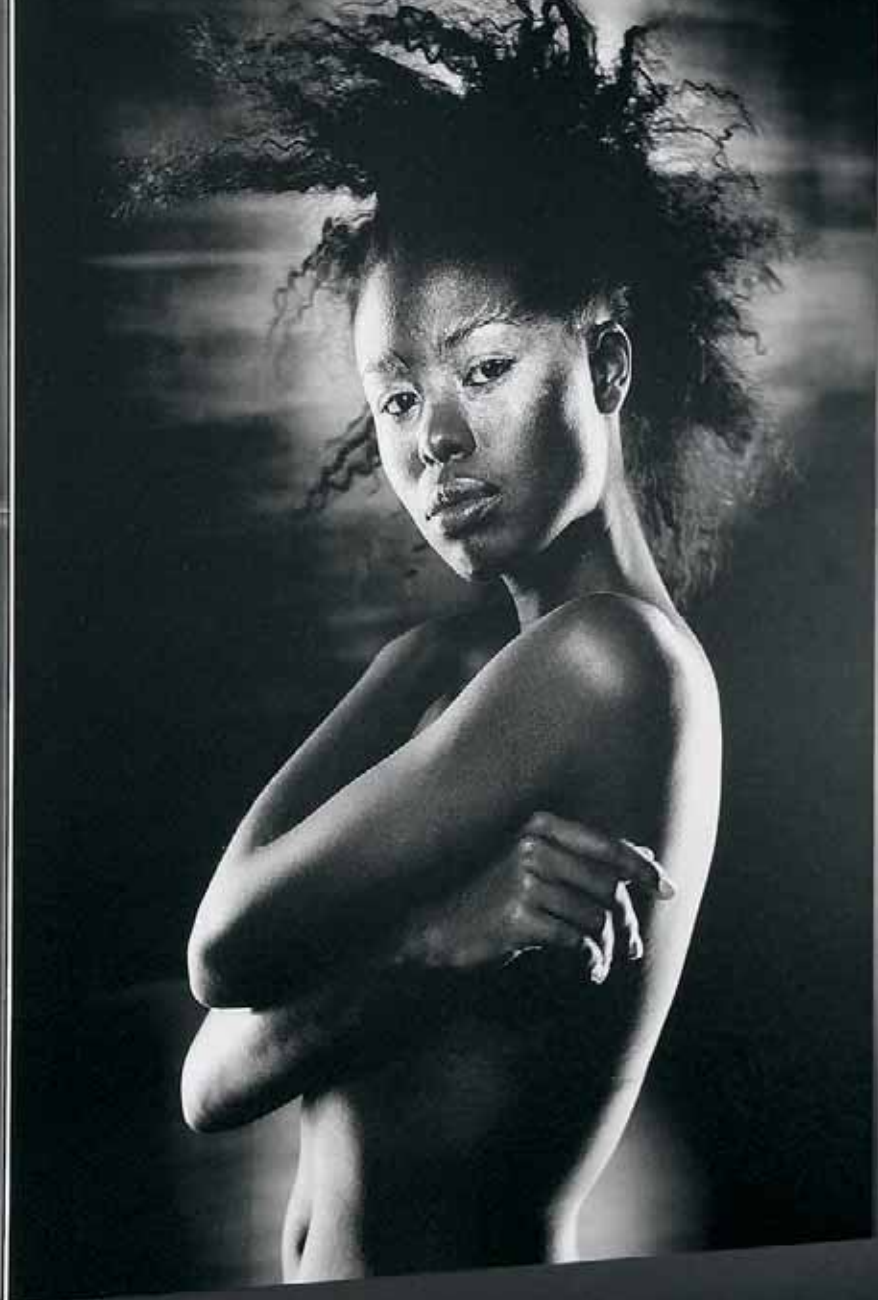

# RIFLESSI

Design Athena



## Art. 1299

Accessorio per dimmerazione e per l'ordine della plafoniera completa di accessorio di dimmerazione (max 50W)  
 Richiedere: COD SOSP: + 1299 (es: 8954 + 1299)

To order ceiling fixtures with dimmer ask: SUSP. CODE + 1299 (es: 8954 + 1299)

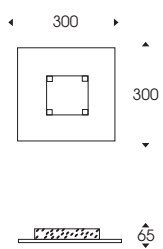

### 5831 1 cromo - chrome

LED 220v 4x4,3w = 17.20w  
 LED DIMMERABILI

Colori led - led colours

- 1 Natural white 4000°K 1440 lm
- 6 Warm white 3000°K 1320 lm

CE IP 20 F ± GR 2550  
**LED CRI >80** A

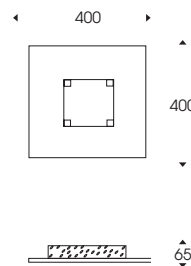

### 5832 1 cromo - chrome

LED 220v 4x4,3w = 17.20w  
 LED DIMMERABILI

Colori led - led colours

- 1 Natural white 4000°K 1440 lm
- 6 Warm white 3000°K 1320 lm

CE IP 20 F ± GR 4220  
**LED CRI >80** A

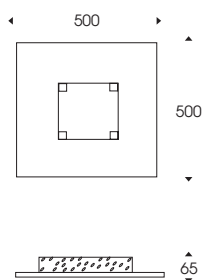

### 5833 1 cromo - chrome

LED 220v 4x8,6w = 34.40w  
 LED DIMMERABILI

Colori led - led colours

- 1 Natural white 4000°K 2960 lm
- 6 Warm white 3000°K 2640 lm

CE IP 20 F ± GR 6360  
**LED CRI >80** A

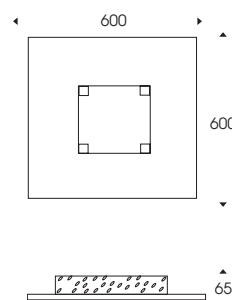

### 5834 1 cromo - chrome

LED 220v 4x8,6w = 34.40w  
 LED DIMMERABILI

Colori led - led colours

- 1 Natural white 4000°K 2960 lm
- 6 Warm white 3000°K 2640 lm

CE IP 20 F ± GR 7880  
**LED CRI >80** A



# KITE

Design Athena

Collezione di plafoniere, sospensioni, appliques in vetro extra chiaro trasparente sabbiato internamente.  
Particolari in policarbonato e finiture in acciaio lucido.

*A collection of ceiling light fixtures, suspension and wall light fixtures with extra-clear transparent/internal satinized glass.*

*The details are poly-carbonate and the finishing of polished chrome steel.*

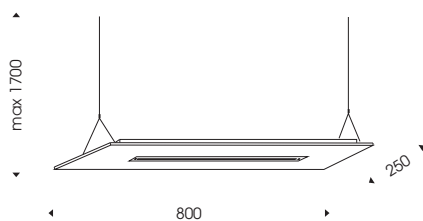

**5851 1** cromo - chrome

220/240v T5 2x24W

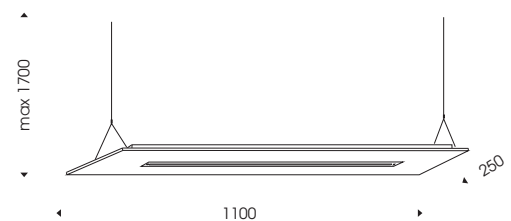

**5852 1** cromo - chrome

220/240v T5 2x39W







## KITE

Design Athena

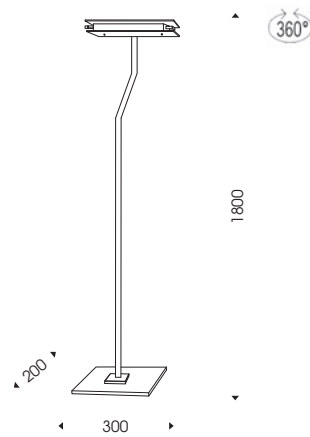

5880 1 cromo - *chrome*

5880 5 bianco - *white*

5880 7 grigio - *grey*

5880 9 nero - *black*

220/240v ECO R7s mm 117 Max 160W



360°

orientabile - *adjustable*



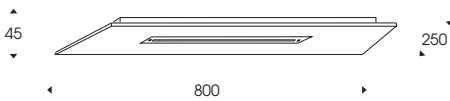

**5841 1** cromo - chrome

220/240v T5 2x24W

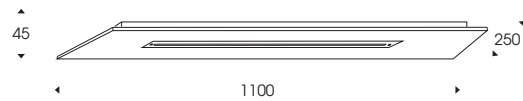

**5842 1** cromo - chrome

220/240v T5 2x39W

## KITE

Design Athena

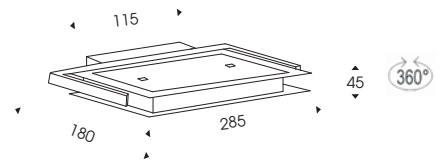

5862 1 cromo - chrome

5862 5 bianco - white

5862 7 grigio - grey

5862 9 nero - black

220/240V ECO R7s mm117 160W

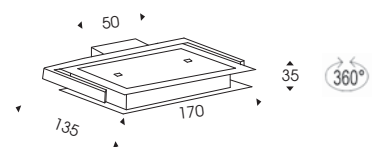

5863 1 cromo - chrome

5863 5 bianco - white

5863 7 grigio - grey

5863 9 nero - black

220/240V ECO G9 max 48W



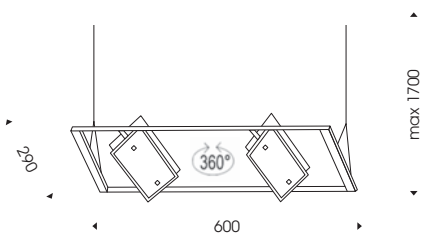

**5858 1** cromo - chrome

220/240V ECO R7s mm117 2x160W

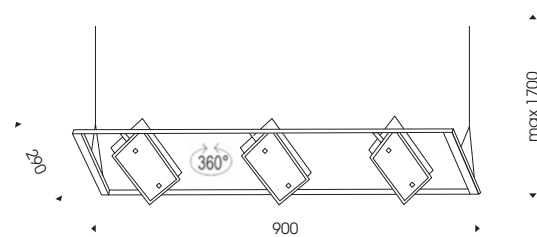

**5859 1** cromo - chrome

220/240V ECO R7s mm117 3x160W





# MAGIC LED

Design Athena

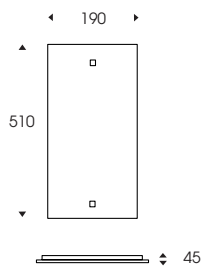

## 684311 cromo NW - chrome Nw

220/240V LED 11W  
Driver incluso *Driver included*

Colori led - *led colours*

1 Natural white  
4000°K 1450 lm

CE IP 20    LED CRI >80 

## 684316 cromo WW - chrome WW

220/240V LED 11W  
Driver incluso *Driver included*

Colori led - *led colours*

6 Warm white  
3000°K 1350 lm

CE IP 20    LED CRI >80 





# ONDA

Design Athena

Collezione di plafoniere e sospensioni studiate per l'utilizzo delle lampade a risparmio energetico T5 da 24 e 39W in vetro extrachiaro trasparente sabbiato internamente. Particolari in policarbonato e finiture in acciaio lucido.

Collection of ceiling lights and hanging lamps designed for use with the 24 and 39W T5 energy-saving lamps in transparent extra-clear glass, sandblasted internally. Details in polycarbonate and glossy steel finishing.

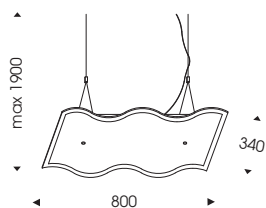

**6651 1** cromo - chrome

220/240v T5 2x24W

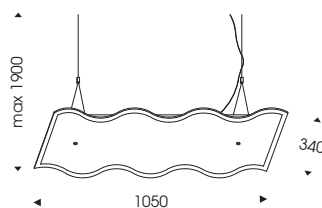

**6652 1** cromo - chrome

220/240v T5 2x39W



# ONDA

Design Athena

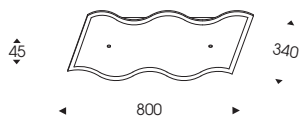

**6641 1** cromo - chrome

220/240v T5 2x24W

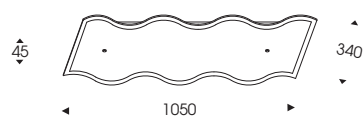

**6642 1** cromo - chrome

220/240v T5 2x39W



# ALPHA

Design Athena

Collezione di faretti, applique e lampada da tavolo a led, realizzate in metallo con faretti orientabili o con flessibile. La nuova tecnologia led per illuminare e valorizzare sia ambienti lavorativi che abitativi.

Collection of metal spotlights, wall lamps and LED table lamps with adjustable spotlights or flexible arms. New LED technology for lighting and enhancing both workplaces and homes.

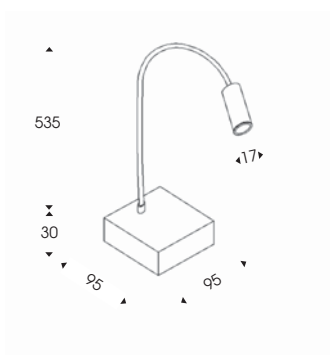

**8430 1** cromo - *chrome*

**8430 2** nichel satinato - *nickel*

220/240v 1x2W flex mm500 Ø 8

Colori led - *led colours*

■ 1 Natural white 4000-4500°K ■ 6 Warm white 3000-3200°K

CE IP 40   

Driver incluso.

Interruttore integrato alla base

*Driver included - Switch integrated into base*

Composizione codice (rispettare la sequenza):

8430 - nickel - warmwhite = 8430.2.6

## ALPHA

Design Athena

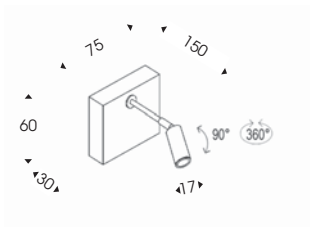
**8201 1** cromo - *chrome***8201 2** nichel satinato - *nickel*

220/240v 1x2W

Colori led - *led colours*

■ 1 Natural white 4000-4500°K	■ 6 Warm white 3000-3200°K
----------------------------------	-------------------------------

CE IP 40     
235

Driver incluso.

*Driver included*

Composizione codice (rispettare la sequenza):

8201 - nickel - warmwhite = 8201.2.6

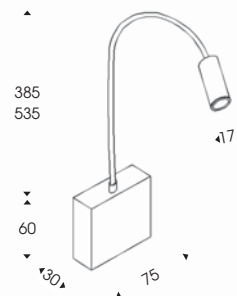
**8401 1** cromo - *chrome***8401 2** nichel satinato - *nickel*

220/240v 1x2W flex mm350 Ø 8

**8411 1** cromo - *chrome***8411 2** nichel satinato - *nickel*

220/240v 1x2W flex mm500 Ø 8

Colori led - *led colours*

■ 1 Natural white 4000-4500°K	■ 6 Warm white 3000-3200°K
----------------------------------	-------------------------------

CE IP 40     
270 300  
8401 8411

Driver incluso. Interruttore integrato alla base

*Driver included - Switch integrated into base*

Composizione codice (rispettare la sequenza):

8401 - nickel - warmwhite = 8401.2.6

# BETA

Design Athena

Collezione di faretti, applique e lampada da tavolo a led, realizzate in metallo con faretti orientabili o con flessibile.  
La nuova tecnologia led per illuminare e valorizzare sia ambienti lavorativi che abitativi.

Collection of metal spotlights, wall lamps and LED table lamps with adjustable spotlights or flexible arms. New LED technology for lighting and enhancing both workplaces and homes.

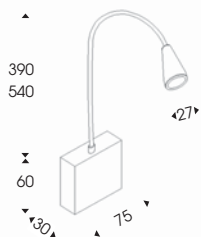

**8501 1** cromo - chrome

**8501 2** nichel satinato - nickel

220/240v 1x2W flex mm350 Ø 8

**8511 1** cromo - chrome

**8511 2** nichel satinato - nickel

220/240v 1x2W flex mm500 Ø 8

Colori led - led colours

■ 1 Natural white 4000-4500°K ■ 6 Warm white 3000-3200°K



Driver incluso.

Interruttore integrato alla base

Driver included - Switch integrated into base

Composizione codice (rispettare la sequenza):

8501 - nickel - warmwhite = 8501.2.6

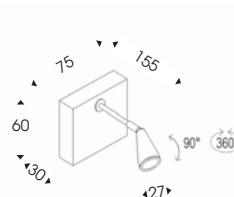

**8301 1** cromo - chrome

**8301 2** nichel satinato - nickel

220/240v 1x2W

Colori led - led colours

■ 1 Natural white 4000-4500°K ■ 6 Warm white 3000-3200°K



Driver incluso.

Driver included

Composizione codice (rispettare la sequenza):

8301 - nickel - warmwhite = 8301.2.6

## BETA

Design Athena

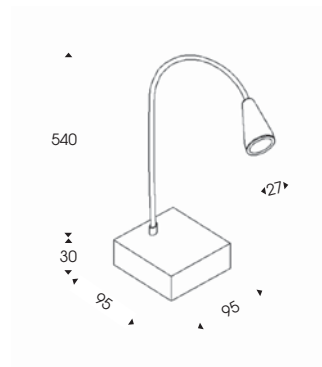
**8530 1** cromo - chrome**8530 2** nichel satinato - nickel

220/240v 1x2W flex mm500 Ø 8

Colori led - led colours

■ 1 Natural white	■ 6 Warm white
4000-4500°K	3000-3200°K

CE IP 40    

Driver incluso.

Interruttore integrato alla base

Driver included - Switch integrated into base

Composizione codice (rispettare la sequenza):

8530 - nickel - warmwhite = 8530.2.6

## METAL LED

Design Athena

Collezione di applique in metallo cromato o bianco opaco che valorizzano e illuminano con armonia l'ambiente in cui vengono inserite.

Chrome-plate metal or matt white wall lamp collection designed to enhance and illuminate the environment in which they are inserted without clashing.

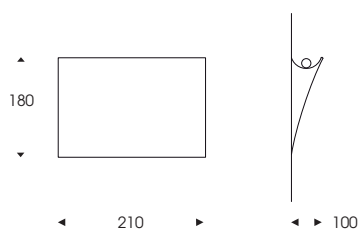

**646116** cromo - chrome

**646156** bianco - white

220/240v LED 13,5W

Colori led - led colours

■ 6 Warm white  
1600 lm

CE IP 20    LED CRI >80 

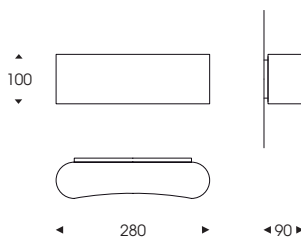

**646216** cromo - chrome

**646256** bianco - white

220/240v LED 13,5W

Colori led - led colours

■ 6 Warm white  
1600 lm

CE IP 20    LED CRI >80 

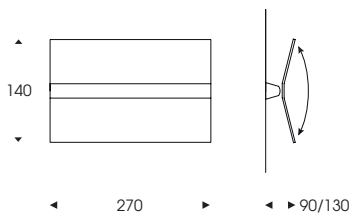

**646016** cromo - chrome

**646056** bianco - white

220/240v LED 13,5W

Colori led - *led colours*

■ 6 Warm white  
1600 lm

CE IP 20   



## ARTE

Design Athena

Collezione di applique realizzate in metallo nelle versioni con la nuova tecnologia led. Tutti gli apparecchi offrono la possibilità di orientare le luci. Adatte all'illuminazione di quadri e specchi o come applique in ambienti lavorativi e abitativi.

Collection of metal wall lamps available with new LED technology. All of these items offer the possibility to adjust the direction of light. Suitable for lighting pictures and mirrors or for use as wall lamps in workplaces and homes.

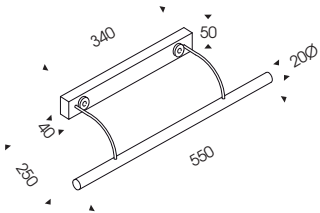
**8709 1** cromo - chrome**8709 3** oro zecchino - gold

220/240V LED 4x4,2W

Colori led - led colours

- |                                       |                                      |
|---------------------------------------|--------------------------------------|
| ■ 1 Natural white<br>4000°K<br>2080lm | ■ 6 Warm white<br>3000 °K<br>1920 lm |
|---------------------------------------|--------------------------------------|

CE IP 20 LED CRI >80

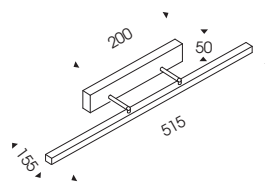
**8730 5** bianco NW - white NW**8730 7** grigio NW - grey NW220/240V 9,6W strip 120 led  
Driver incluso Driver included

Colori led - led colours

- |                                           |                                          |
|-------------------------------------------|------------------------------------------|
| ■ 1 Natural white<br>4000-4500°K<br>800lm | ■ 6 Warm white<br>2800-3200 °K<br>770 lm |
|-------------------------------------------|------------------------------------------|

CE IP 20 LED CRI >80





## ARTE

Design Athena

## LED

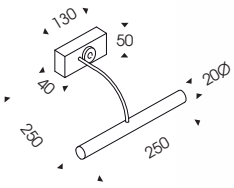
**8708 1** cromo - chrome**8708 3** oro zecchino - gold

220/240v 2x4,2W

## Colori led - led colours

■ 1 Natural white 4000°K 1040lm	■ 6 Warm white 3000°K 960lm
---------------------------------------	-----------------------------------

CE IP 20 LED CRI >80

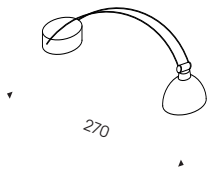
**5722 1** cromo - chrome

12v G 5,3 50W max Halo  
12v G 5,3 LED

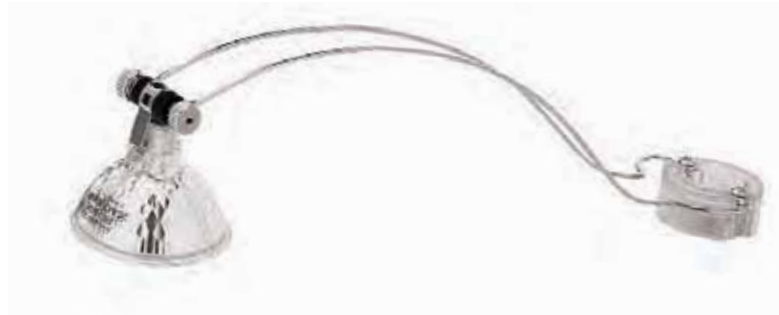

CE IP 20

# ARTE

Design Athena

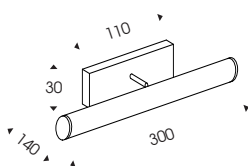

**8706 1** cromo - chrome

**8706 3** oro lucido - gold

220/240v LED 2x4,3W

Colori led - led colours

- 1 Natural white 720lm
- 6 Warm white 660lm

CE IP 20 LED CRI >80

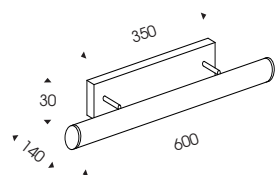

**8707 1** cromo - chrome

**8707 3** oro lucido - gold

220/240v LED 4x4,3W

Colori led - led colours

- 1 Natural white 1440lm
- 6 Warm white 1320lm

CE IP 20 LED CRI >80

# FARETTI-POKER

Design Athena

Collezione di farette e barre orientabili disponibili sia nella versione ad incandescenza che con la nuova tecnologia led.  
Collection of spot and bars with adjustable spot available for incandescent light or new led technology.

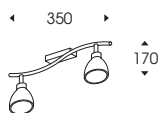

**470582 1** cromo - *chrome*  
**470582 5** bianco - *white*

220/240v ECO G9 2x33W max

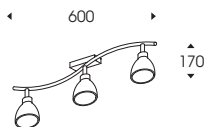

**470583 1** cromo - *chrome*  
**470583 5** bianco - *white*

220/240v ECO G9 3x33W max

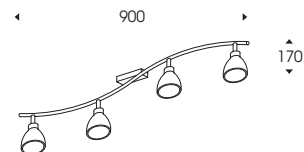

**470584 1** cromo - *chrome*  
**470584 5** bianco - *white*

220/240v ECO G9 4x33W max



**4705 1** cromo - *chrome*  
**4705 5** bianco - *white*

2320/240v ECO G9 33W max



# FARETTI-MERCURY

Design Athena

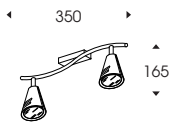

**473582 1** cromo - *chrome*  
**473582 5** bianco - *white*

220/240v GZ10 2x50W max Halo  
 220/240v 2xGU10 LED

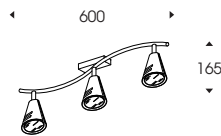

**473583 1** cromo - *chrome*  
**473583 5** bianco - *white*

220/240v GZ10 3x50W max Halo  
 220/240v 3xGU10 LED

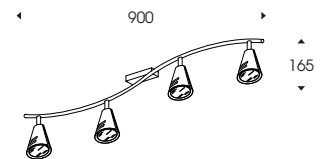

**473584 1** cromo - *chrome*  
**473584 5** bianco - *white*

220/240v GZ10 4x50W max Halo  
 220/240v 4xGU10 LED

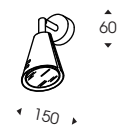

**3501 1** cromo - *chrome*  
**3501 5** bianco - *white*

220/240v GZ10 50W max Halo  
 220/240v GU10 LED



# FARETTI-JARIS

Design Athena

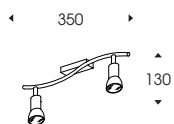

**474182 1** cromo - *chrome*  
**474182 5** bianco - *white*

220/240v GZ10 2x50W max Halo  
220/240v 2XGU10 LED

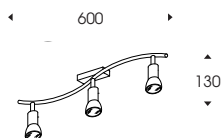

**474183 1** cromo - *chrome*  
**474183 5** bianco - *white*

220/240v GZ10 3x50W max Halo  
220/240v 3XGU10 LED

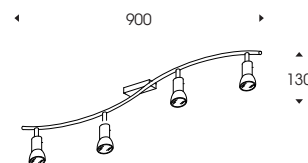

**474184 1** cromo - *chrome*  
**474184 5** bianco - *white*

220/240v GZ10 4x50W max Halo  
220/240v 4XGU10 LED



**4101 1** cromo - *chrome*  
**4101 5** bianco - *white*

220/240v GZ10 50W max Halo  
220/240v GU10 LED



# FARETTI-SPOT

Design Athena

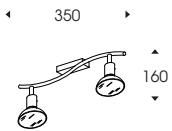

**477282 1** cromo - *chrome*  
**477282 5** bianco - *white*

220/240v E27 2x75W max

CE IP 20

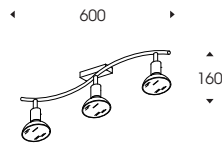

**477283 1** cromo - *chrome*  
**477283 5** bianco - *white*

220/240v E27 3x75W max

CE IP 20

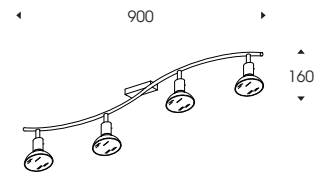

**477284 1** cromo - *chrome*  
**477284 5** bianco - *white*

220/240v E27 4x75W max

CE IP 20

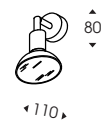

**7201 1** cromo - *chrome*  
**7201 5** bianco - *white*  
**7201 7** grigio - *grey*  
**7201 9** nero - *black*

220/240v E27 75W max

CE IP 20







178  
ORIONE



198  
PEGASO



# ORIONE

Design Athena

Faretto da incasso fisso per interno con corpo in ottone. Completo di molle per installazione.  
 Indoor fixed recessed metal spot light. Copper structure. Springs included.

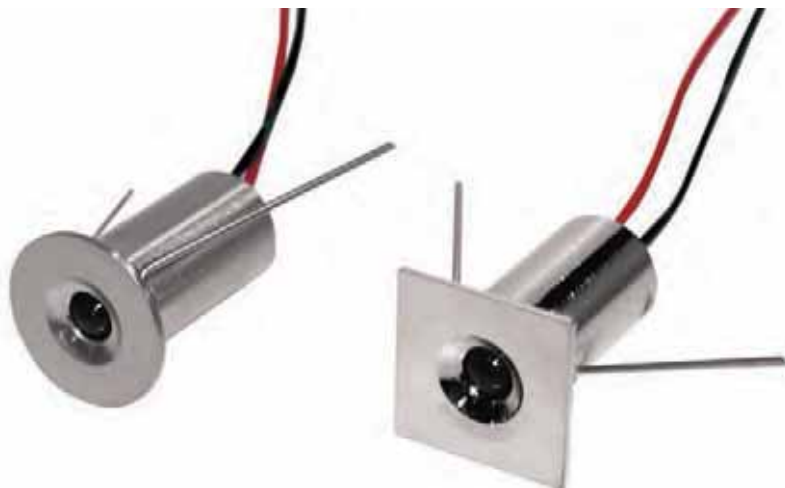

**1130**

Cassaforma - Mould



Driver non incluso.  
 Solo collegamento in parallelo.  
 Driver not included - Only parallel connection.

Composizione codice (rispettare la sequenza):  
 11301 - cromo - nat. white = 11301.1.1



- 11301 1** cromo - chrome
- 11301 2** nichel satinato - nickel
- 11301 5** bianco opaco - matt white

1x0,5W Ø5mm 24Vdc 20mA 120°

Colori led - led colours

- 1 Natural white
- 2 Blue
- 4 Green
- 6 Warm white
- 8 Red
- 9 RGB



14

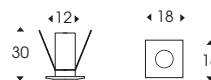

- 11311 1** cromo - chrome
- 11311 2** nichel satinato - nickel
- 11311 5** bianco opaco - matt white

1x0,5W Ø5mm 24Vdc 20mA 120°

Colori led - led colours

- 1 Natural white
- 2 Blue
- 4 Green
- 6 Warm white
- 8 Red
- 9 RGB



14

## ACCESSORI

Utilizzare alimentatori 24Vdc da pag. 204  
 Use drivers 24 Vdc from page 204

# ORIONE

Design Athena

Faretto ad incasso fisso per interno/esterno, completo di molle per controsoffitto e cavo FROR cm.50.  
Corpo in alluminio anodizzato, ghiera in ottone o acciaio AISI 316. Vetro temprato satinato. Calpestabile.

Indoor/outdoor fixed recessed spot light. Ceiling springs and wire FROR cm 50 included. Aluminium structure, copper or steel AISI 316 front piece.  
Tempered satin glass. Walkable.

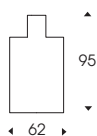

**1131**  
Cassaforma + OR  
Mould + OR



**1140**  
Ghiera - Ferrule



Driver non incluso.  
Solo collegamento in serie.  
Driver not included - Only serial connection.

Composizione codice  
(rispettare la sequenza):  
11302 - cromo - warmwhite = 11302.1.6

Se interrati, prevedere un drenaggio con ghiaia di circa 20/30 cm.  
Utilizzare esclusivamente cavi ed accessori con grado di protezione per uso esterno.  
If underground, provide a drainage with gravel 20/30 cm height use only outdoor protection wires accessories.

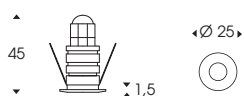

**11302 1** cromo - chrome  
**11302 2** nichel satinato - nickel (uso interno)

**11342 6** acciaio - steel

1x1W 350 mA 120° lm100

Colori led - led colours

■ 1 Natural white 4000-4500°K ■ 5 Cold white 5000-5500°K ■ 6 Warm white 3000-3200°K



CE

IP 67



LED >80



20



**11312 1** cromo - chrome  
**11312 2** nichel satinato - nickel (uso interno)

**11352 6** acciaio - steel

1x1W 350 mA 120° lm100

Colori led - led colours

■ 1 Natural white 4000-4500°K ■ 5 Cold white 5000-5500°K ■ 6 Warm white 3000-3200°K



CE

IP 67



LED >80



20

## ACCESSORI

Utilizzare alimentatori 350mA da pag. 204 - Schemi assemblaggio da pag. 214  
Use drivers 350mA from page 204 - Assembly schemes from page 214

# ORIONE

Design Athena

Faretto ad incasso fisso per interno/esterno, completo di molle per controsoffitto e cavo FROR cm.50.  
Corpo in alluminio anodizzato, ghiera in ottone o acciaio AISI 316. Vetro temprato satinato. Calpestabile.

Indoor/outdoor fixed recessed spot light. Ceiling springs and wire FROR cm 50 included. Aluminium structure, copper or steel AISI 316 front piece.  
Tempered satin glass. Walkable.



**1132**

Cassaforma + OR

Mould + OR

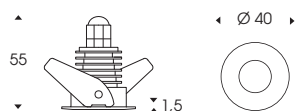

**11303 1** cromo - chrome

**11303 2** nichel satinato - nickel (uso interno)

**11343 6** acciaio - steel

1x1W 350 mA lm100 - 1x2W 500 mA lm150

Colori led - led colours

■ 1 Natural white 4000-4500°K   ■ 5 Cold white 5000-5500°K   ■ 6 Warm white 3000-3200°K

Ottica - Optics

- 1 25° vetro trasparente - clear glass
- 2 40° vetro trasparente - clear glass
- 3 120° vetro sabbaiato - satined glass



Driver non incluso.  
Solo collegamento in serie.

Driver not included - Only serial connection.

Composizione codice  
(rispettare la sequenza):

11343 - acciaio - nat. white -40° = 11343.6.1.2

Se interrati, prevedere un drenaggio con ghiaia di circa 20/30 cm.

Utilizzare esclusivamente cavi ed accessori con grado di protezione per uso esterno.

If underground, provide a drainage with gravel 20/30 cm height use only outdoor protection wires accessories.

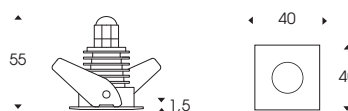

**11313 1** cromo - chrome

**11313 2** nichel satinato - nickel (uso interno)

**11353 6** acciaio - steel

1x1W 350 mA lm100 - 1x2W 500 mA lm150

Colori led - led colours

■ 1 Natural white 4000-4500°K   ■ 5 Cold white 5000-5500°K   ■ 6 Warm white 3000-3200°K

Ottica - Optics

- 1 25° vetro trasparente - clear glass
- 2 40° vetro trasparente - clear glass
- 3 120° vetro sabbaiato - satined glass



## ACCESSORI

Utilizzare alimentatori 350mA-500mA da pag. 204 - Schemi assemblaggio da pag. 214  
Use drivers 350mA-500mA from page 204 - Assembly schemes from page 214

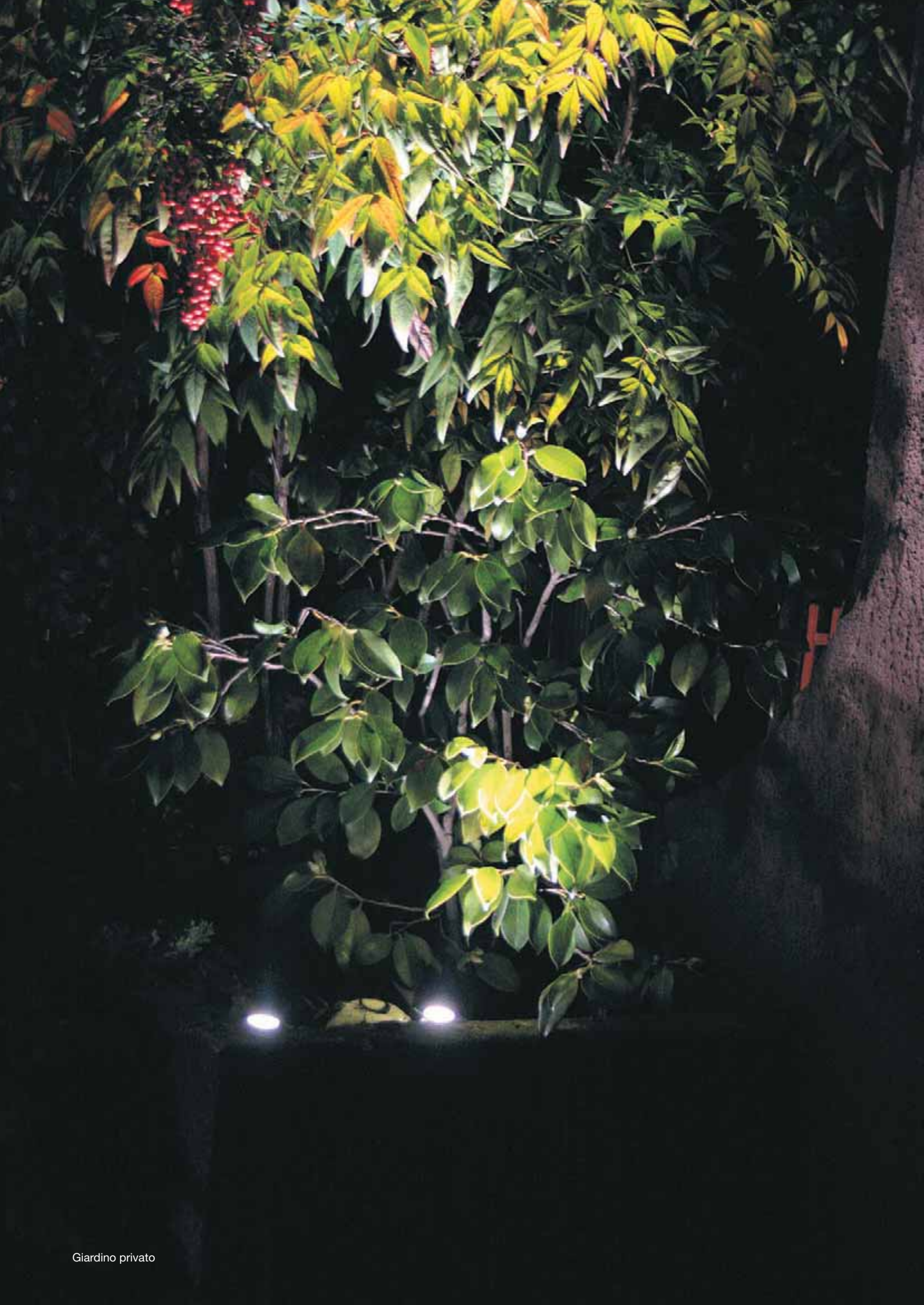

# ORIONE

Design Athena

Faretto ad incasso fisso per interno/esterno, completo di molle per controsoffitto e cavo FROR cm.50.  
Corpo in alluminio anodizzato, ghiera in ottone o acciaio AISI 316. Vetro temprato satinato. Calpestabile.

Indoor/outdoor fixed recessed spot light. Ceiling springs and wire FROR cm 50 included. Aluminium structure, copper or steel AISI 316 front piece.  
Tempered satin glass. Walkable.



**1133**

Cassaforma + OR

Mould + OR



Driver non incluso.  
Solo collegamento in serie.

Driver not included - Only serial connection.

Composizione codice  
(rispettare la sequenza):

11344 - acciaio - nat. white -40° = 11344.6.1.2

Se interrati, prevedere un drenaggio con ghiaia di circa 20/30 cm.  
Utilizzare esclusivamente cavi ed accessori con grado di protezione per uso esterno.  
If underground, provide a drainage with gravel 20/30 cm height use only outdoor protection wires accessories.

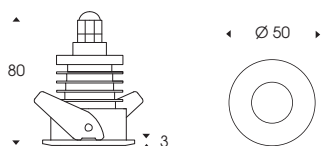

**11304 1** cromo - chrome

**11304 2** nichel satinato - nickel (uso interno)

**11344 6** acciaio - steel

1x1W 350 mA lm100 - 1x2W 500 mA lm150 - 1x3W 700 mA lm200

Colori led - led colours

1 Natural white 4000-4500°K    5 Cold white 5000-5500°K    6 Warm white 3000-3200°K    9 RGB 3W 350 mA

Ottica - Optics

1 25° trasparente - clear    2 40° trasparente - clear    3 120° sabbiato - satined

**11324 1** cromo - chrome

**11324 2** nichel satinato - nickel (uso interno)

1x4,5W 240 mA

Colori led - led colours

1 Natural white 4000°K lm400    6 Warm white 3000°K lm360

Ottica - Optics 120° sabbiato - satined



CE IP 67 F LED >80 A

45

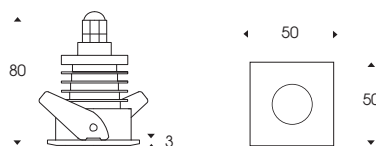

**11314 1** cromo - chrome

**11314 2** nichel satinato - nickel (uso interno)

**11354 6** acciaio - steel

1x1W 350 mA lm100 - 1x2W 500 mA lm150 - 1x3W 700 mA lm200

Colori led - led colours

1 Natural white 4000-4500°K    5 Cold white 5000-5500°K    6 Warm white 3000-3200°K    9 RGB 3W 350 mA

Ottica - Optics

1 25° trasparente - clear    2 40° trasparente - clear    3 120° sabbiato - satined

**11334 1** cromo - chrome

**11334 2** nichel satinato - nickel (uso interno)

1x4,5W 240 mA

Colori led - led colours

1 Natural white 4000°K lm400    6 Warm white 3000°K lm360

Ottica - Optics 120° sabbiato - satined



CE IP 67 F LED >80 A

45

## ACCESSORI

Utilizzare alimentatori 350mA-500mA-700mA da pag. 204 - Schemi assemblaggio da pag. 214  
Use drivers 350mA-500mA-700mA from page 204 - Assembly schemes from page 214



# ORIONE

Design Athena

Faretto ad incasso fisso per interno/esterno, completo di molle per controsoffitto e cavo FROR cm.50.  
Corpo in alluminio anodizzato, ghiera in ottone o acciaio AISI 316. Vetro temprato satinato.

Indoor/outdoor fixed recessed spot light. Ceiling springs and wire FROR cm 50 included. Aluminium structure, copper or steel AISI 316 front piece.  
Tempered satin glass.

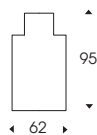

**1133**

Cassaforma + OR

Mould + OR



Driver non incluso.  
Solo collegamento in serie.

Driver not included - Only serial connection.

Composizione codice  
(rispettare la sequenza):

11346 - acciaio - nat. white = 11346.6.1

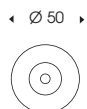
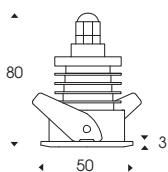

**11306 1** cromo - chrome

**11306 2** nichel satinato - nickel (uso interno)

**11346 6** acciaio - steel

1x1W 350 mA lm100 - 1x2W 500 mA lm150 - 1x3W 700 mA lm200

Colori led - led colours

■ 1 Natural white 4000-4500°K ■ 5 Cold white 5000-5500°K ■ 6 Warm white 3000-3200°K



CE IP 67 F III GR 152 A

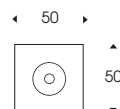
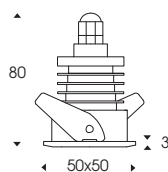

**11316 1** cromo - chrome

**11316 2** nichel satinato - nickel (uso interno)

**11356 6** acciaio - steel

1x1W 350 mA lm100 - 1x2W 500 mA lm150 - 1x3W 700 mA lm200

Colori led - led colours

■ 1 Natural white 4000-4500°K ■ 5 Cold white 5000-5500°K ■ 6 Warm white 3000-3200°K



CE IP 67 F III GR 164 A

## ACCESSORI

Utilizzare alimentatori 350mA-500mA-700mA da pag. 204 - Schemi assemblaggio da pag. 214  
Use drivers 350mA-500mA-700mA from page 204 - Assembly schemes from page 214

# ORIONE

Design Athena

Faretto ad incasso fisso per interno/esterno completo di molle per controsoffitto e cavo FROR cm 50.  
Corpo in alluminio anodizzato, ghiera in ottone o acciaio AISI 316. Vetro temprato. Calpestabile nelle versioni cromo e acciaio.

Indoor/outdoor fixed recessed metal spot light. Ceiling springs and wire FROR cm 50 included. Aluminium structure, copper or steel AISI 316 front piece.  
Tempered glass. Walkable only for chrome and steel structures

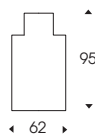

**1133**

Cassaforma + OR

Mould + OR



Driver non incluso.  
Solo collegamento in serie.

Driver not included - Only serial connection.

Composizione codice  
(rispettare la sequenza):

11347 - acciaio - nat. white = 11347.6.1

Se interrati, prevedere un drenaggio con ghiaia di circa 20/30 cm.

Utilizzare esclusivamente cavi ed accessori con grado di protezione per uso esterno.

If underground, provide a drainage with gravel 20/30 cm height use only outdoor protection wires accessories.

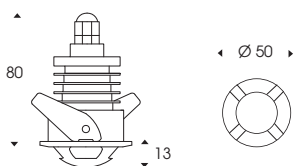

**11307 1** cromo - chrome

**11307 2** nichel satinato - nickel (uso interno)

**11347 6** acciaio - steel

1x1W 350 mA lm100 - 1x2W 500 mA lm150 - 1x3W 700 mA lm200

Colori led - led colours

■ 1 Natural white 4000-4500°K   ■ 5 Cold white 5000-5500°K   ■ 6 Warm white 3000-3200°K



45

## ACCESSORI

Utilizzare alimentatori 350mA-500mA-700mA da pag. 204 - Schemi assemblaggio da pag. 214  
Use drivers 350mA-500mA-700mA from page 204 - Assembly schemes from page 214

# ORIONE

Design Athena

Faretti da incasso fissi per interni a led da 2,6W in metallo. Applicazione con molle per mensole, pensili e controsoffitti.  
*Indoor fixed recessed LED spotlight. Application with springs for shelves and wall cabinets.*

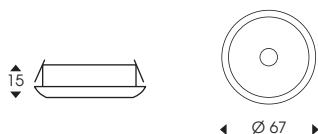

**11462 1** cromo - *chrome*

**11462 3** oro - *gold*

**11462 5** bianco opaco - *matt white*

**11462 9** nero opaco - *matt black*

1x2,6W 140mA 120°

Colori led - *led colours*

■ 1 Natural white 4000°K 235 lm	■ 6 Warm white 3000°K 210 lm
---------------------------------------	------------------------------------



CE IP 20

58

Driver non incluso.  
Solo collegamento in serie.  
*Driver not included - Only serial connection*

## ACCESSORI

Alimentatori elettronici per power led 140 mA da pag. 204 - Schemi assemblaggio da pag. 214  
*Electronic driver for power led 140 mA from page 204 - Assembly schemes from page 214*

# ORIONE

Design Athena

Faretti da incasso fissi per interni a led da 6,6W. Corpo in metallo, anello in vetro bianco satinato.

Indoor fixed recessed LED spotlight. Satin finished glass.

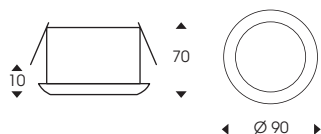

**11463 1** vetro bianco - white glass

1x6,6W 350mA 120°

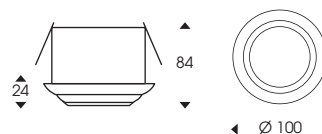

**11464 1** vetro bianco - white glass

1x6,6W 350mA 120°

#### Colori led - led colours

■ 1 Natural white 4000°K 600 lm  
 ■ 6 Warm white 3000°K 540 lm



75

#### Colori led - led colours

■ 1 Natural white 4000°K 600 lm  
 ■ 6 Warm white 3000°K 540 lm



75

Driver non incluso.  
 Solo collegamento in serie.

Driver not included - Only serial connection

## ACCESSORI

Alimentatori elettronici per power led 350 mA da pag. 204 - Schemi assemblaggio da pag. 214  
 Electronic driver for power led 350 mA from page 204 - Assembly schemes from page 214



# ORIONE

Design Athena

Faretto orientabile da incasso. Corpo faretto in ottone. Ghiera in metallo. Applicazione con molle per controsoffitto  
Adjustable recessed spotlight. Copper structure, metal front piece. Application with springs for false ceiling



Driver non incluso.  
Solo collegamento in serie.  
Driver not included - Only serial connection

Composizione codice (rispettare la sequenza):  
11401 - cromo - warmwhite - 38° = 11401.1.6.2



- 11401 1** cromo - *chrome*
- 11401 2** nichel satinato - *nickel*
- 11401 5** bianco opaco - *matt white*

1x6,6W 350mA

Colori led - *led colours*

- 1 Natural white 4000°K lm600
- 6 Warm white 3200°K lm540
- 9 RGB 11,5W H81 3 LED 45°

Ottica - *Optics*

- 1 18° 2 38° 3 54°



75

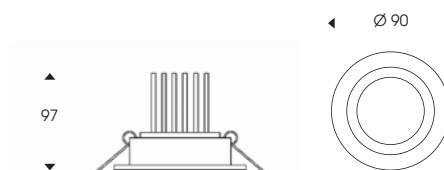

- 11402 1** cromo - *chrome*
- 11402 2** nichel satinato - *nickel*
- 11402 5** bianco opaco - *matt white*

1x9,8W 350mA

Colori led - *led colours*

- 1 Natural white 4000°K lm810
- 6 Warm white 3200°K lm740

Ottica - *Optics*

- 1 18° 2 38° 3 54°



75

## ACCESSORI

Utilizzare alimentatori 350mA da pag. 204 - Schemi assemblaggio da pag. 214  
Use drivers 350mA from page 204 - Assembly schemes from page 214

# ORIONE

Design Athena

Faretto orientabile da incasso in metallo. Corpo faretto in ottone, ghiera in metallo. Applicazione con molle per controsoffitto.  
Adjustable recessed metal spotlight. Copper structure, metal front piece. Application with springs for false ceiling.



Driver non incluso. Solo collegamento in serie.

Driver not included - Only serial connection

Composizione codice (rispettare la sequenza):

11411 - cromo - warmwhite - 54° = 11411.1.6.3

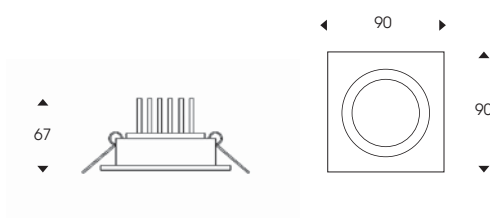

**11411 1** cromo - *chrome*

**11411 2** nichel satinato - *nickel*

**11411 5** bianco opaco - *matt white*

1x6,6W 350mA

Colori led - *led colours*

1 Natural white  
4000°K lm600
  6 Warm white  
3000°K lm540
  9 RGB  
11,5W H81  
3 Led 45°

Ottica - *Optics*

1 18° 2 38° 3 54°



CE IP 20 LED >80

75

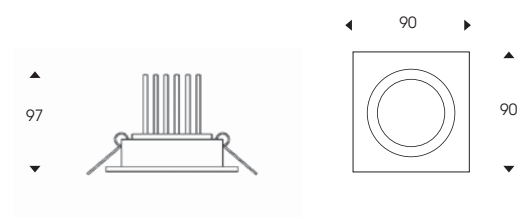

**11412 1** cromo - *chrome*

**11412 2** nichel satinato - *nickel*

**11412 5** bianco opaco - *matt white*

1x9,8W 350mA

Colori led - *led colours*

1 Natural white  
4000°K lm810
  6 Warm white  
3000°K lm740

Ottica - *Optics*

1 18° 2 38° 3 54°



CE IP 20 LED >80

75

## ACCESSORI

Utilizzare alimentatori 350mA da pag. 204 - Schemi assemblaggio da pag. 214  
Use drivers 350mA from page 204 - Assembly schemes from page 214

# ORIONE

Design Athena

Faretto fisso da incasso in metallo. Corpo faretto in ottone, ghiera in metallo. Applicazione con molle per controsoffitto.

Fixed recessed metal spotlight. Copper structure, metal front piece. Application with springs for false ceiling



Driver non incluso. Solo collegamento in serie.

Driver not included - Only serial connection

Composizione codice (rispettare la sequenza):

11421 - cromo - warmwhite - 38° = 11421.1.6.2

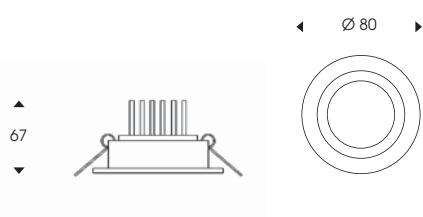

- 11421 1 cromo - chrome
- 11421 2 nichel satinato - nickel
- 11421 5 bianco opaco - matt white

1x6,6W 350mA

Colori led - led colours

- 1 Natural white 4000°K lm600
- 6 Warm white 3200°K lm540
- 9 RGB 11,5W H81 3 led 45°

Ottica - Optics

- 1 18° 2 38° 3 54°



63

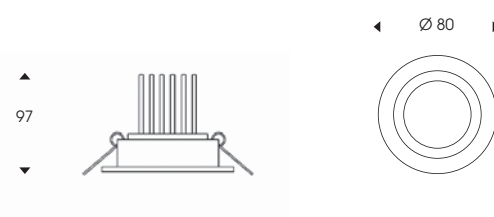

- 11422 1 cromo - chrome
- 11422 2 nichel satinato - nickel
- 11422 5 bianco opaco - matt white

1x9,8W350mA

Colori led - led colours

- 1 Natural white 4000°K lm810
- 6 Warm white 3000°K lm740

Ottica - Optics

- 1 18° 2 38° 3 54°



63

## ACCESSORI

Utilizzare alimentatori 350mA da pag. 204 - Schemi assemblaggio da pag. 214  
Use drivers 350m from page 204 - Assembly schemes from page 214



# ORIONE

Design Athena

Faretto fisso da incasso in metallo. Corpo faretto in ottone, ghiera in metallo. Applicazione con molle per controsoffitto.  
 Fixed recessed metal spotlight. Copper structure, metal front piece. Application with springs for false ceiling



Driver non incluso. Solo collegamento in serie.

Driver not included - Only serial connection

Composizione codice (rispettare la sequenza):

11431 - cromo - warmwhite - 38° = 11431.1.6.2

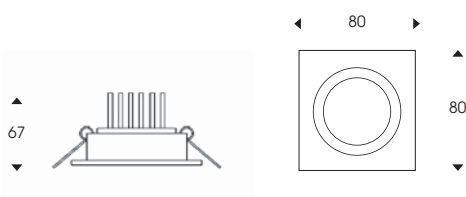

**11431 1** cromo - *chrome*

**11431 2** nichel satinato - *nickel*

**11431 5** bianco opaco - *matt white*

1x6,6W 350mA

Colori led - *led colours*

1 Natural white 4000°K lm600
  6 Warm white 3000°K lm540
  9 RGB 11,5W H81 3 led 45°

Ottica - *Optics*

1 18° 2 38° 3 54°



CE IP 20 F III GR 132 LED >80 A

63

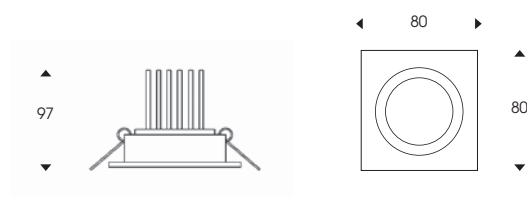

**11432 1** cromo - *chrome*

**11432 2** nichel satinato - *nickel*

**11432 5** bianco opaco - *matt white*

1x9,8W 350mA

Colori led - *led colours*

1 Natural white 4000°K lm810
  6 Warm white 3000°K lm740

Ottica - *Optics*

1 18° 2 38° 3 54°



CE IP 20 F III GR 207 LED >80 A

63

## ACCESSORI

Utilizzare alimentatori 350mA da pag. 204 - Schemi assemblaggio da pag. 214  
 Use drivers 350mA from page 204 - Assembly schemes from page 214



# ORIONE

Design Athena

Faretto orientabile da incasso. Corpo faretto in ottone. Ghiera in metallo. Applicazione con molle per controsoffitto  
Adjustable recessed spotlight. Copper structure, metal front piece. Application with springs for false ceiling



Driver non incluso. Solo collegamento in serie.  
Driver not included - Only serial connection

Composizione codice (rispettare la sequenza):  
11461 - cromo - warmwhite - 35°/40° = 11461.1.6.2

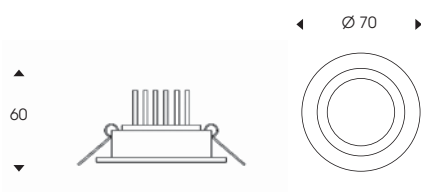

**11461 1** cromo - *chrome*

**11461 2** nichel satinato - *nickel*

**11461 5** bianco opaco - *matt white*

3x1W 350mA lm400

Colori led - *led colours*

■ 1 Natural white 4000°K   ■ 5 Cold white 5500°K   ■ 6 Warm white 3200°K

Ottica - *Optics*

1 20°/24°   2 35°/40°



IP 20



LED >80



## ACCESSORI

Utilizzare alimentatori 350mA da pag. 204 - Schemi assemblaggio da pag. 214  
Use drivers 350mA from page 204 - Assembly schemes from page 214

# ORIONE

Design Athena

Faretto orientabile da incasso. Corpo faretto in ottone. Ghiera in metallo. Applicazione con molle per controsoffitto  
 Adjustable recessed spotlight. Copper structure, metal front piece. Application with springs for false ceiling



Driver non incluso. Solo collegamento in serie.  
 Driver not included - Only serial connection

Composizione codice (rispettare la sequenza):  
 11471 - cromo - warmwhite - 35°/40° = 11471.1.6.2

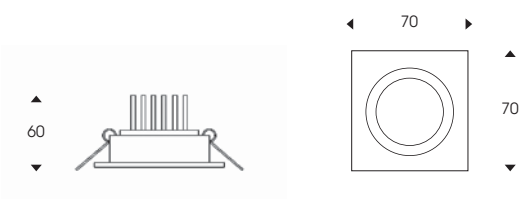

- 11471 1** cromo - *chrome*
- 11471 2** nichel satinato - *nickel*
- 11471 5** bianco opaco - *matt white*

3x1W 350mA lm400

Colori led - *led colours*

- 1 Natural white  
4000°K
- 5 Cold white  
5500°K
- 6 Warm white  
3200°K

Ottica - *Optics*

- 1 20°/24°
- 2 35°/40°



## ACCESSORI

Utilizzare alimentatori 350mA da pag. 204 - Schemi assemblaggio da pag. 214  
 Use drivers 350mA from page 204 - Assembly schemes from page 214

# ORIONE

Design Athena

Faretto fisso da incasso in metallo. Applicazione con molle per controsoffitto.

Fixed recessed metal spotlight. Application with springs for false ceiling



**1150**

Accessorio per fissaggio spot su spessori fino a 5 mm  
Fitting to fix spot on max 5 mm thickness



Driver non incluso. Solo collegamento in serie.

Driver not included - Only serial connection

Composizione codice (rispettare la sequenza):

11481 - cromo - warmwhite = 11481.1.6

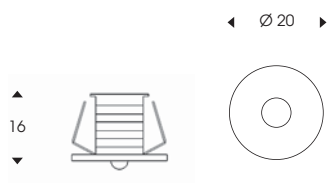

**11481 1** cromo - *chrome*

**11481 2** nichel satinato - *nickel*

**11481 5** bianco opaco - *matt white*

1x1W 350mA lm100

Colori led - *led colours*

1 Natural white 4000-4500°K    5 Cold white 5000-7000°K    6 Warm white 2700-3500°K

8 Red    2 Blue

Ottica - *Optics*

180°



CE IP 20 F III GR 18 A

17

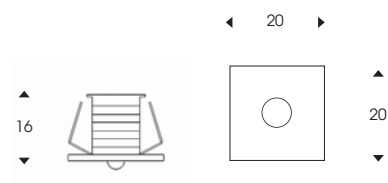

**11491 1** cromo - *chrome*

**11491 2** nichel satinato - *nickel*

**11491 5** bianco opaco - *matt white*

1x1W 350mA lm100

Colori led - *led colours*

1 Natural white 4000-4500°K    5 Cold white 5000-7000°K    6 Warm white 2700-3500°K

8 Red    2 Blue

Ottica - *Optics*

180°



CE IP 20 F III GR 18 A

17

## ACCESSORI

Utilizzare alimentatori 350mA da pag. 204 - Schemi assemblaggio da pag. 214  
Use drivers 350mA from page 204 - Assembly schemes from page 214



# PEGASO

Design Athena

Faretto incasso orientabile. Corpo in metallo.

Adjustable recessed metal downlight.

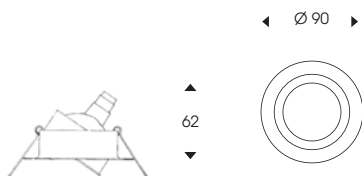

- 1007 1 cromo - chrome
- 1007 2 nichel satinato - nickel
- 1007 3 oro zecchino - gold
- 1007 5 bianco - white
- 1007 9 nero - black

12v G5,3 50W max Halo  
12v G5,3 Led

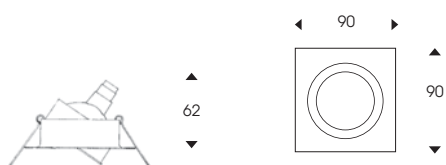

- 1037 1 cromo - chrome
- 1037 2 nichel satinato - nickel
- 1037 3 oro zecchino - gold
- 1037 5 bianco - white
- 1037 9 nero - black

12v G5,3 50W max Halo  
12v G5,3 Led

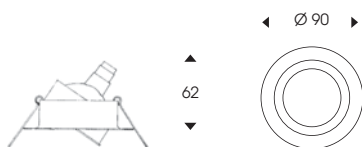

- 1008 1 cromo - chrome
- 1008 2 nichel satinato - nickel
- 1008 3 oro zecchino - gold
- 1008 5 bianco - white
- 1008 9 nero - black

220/240v GZ10 50W max Halo  
220/240v GU10 Led

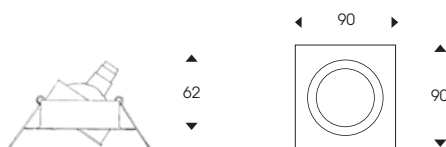

- 1038 1 cromo - chrome
- 1038 2 nichel satinato - nickel
- 1038 3 oro zecchino - gold
- 1038 5 bianco - white
- 1038 9 nero - black

220/240v GZ10 50W max  
220/240v GU10 Led



## ACCESSORI

Trasformatori e specifiche tecniche da pag. 213  
Transformers and technical data from page 213

# PEGASO

Design Athena

Faretto incasso fisso. Corpo in metallo.

Fixed recessed metal spot light.



◀ Ø 80 ▶



- 1009 1 cromo - chrome
- 1009 2 nichel satinato - nickel
- 1009 3 oro zecchino - gold
- 1009 5 bianco - white
- 1009 9 nero - black

12v G5,3 50W max Halo  
12v G5,3 Led



63



◀ 80 ▶



- 1039 1 cromo - chrome
- 1039 2 nichel satinato - nickel
- 1039 3 oro zecchino - gold
- 1039 5 bianco - white
- 1039 9 nero - black

12v G5,3 50W max Halo  
12v G5,3 Led



63

◀ Ø 80 ▶



- 1010 1 cromo - chrome
- 1010 2 nichel satinato - nickel
- 1010 3 oro zecchino - gold
- 1010 5 bianco - white
- 1010 9 nero - black

220/240v GZ10 50W max Halo  
220/240v GU10 Led



63

◀ 80 ▶

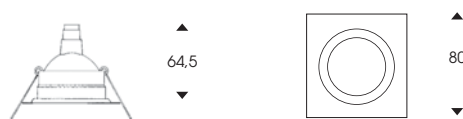

- 1040 1 cromo - chrome
- 1040 2 nichel satinato - nickel
- 1040 3 oro zecchino - gold
- 1040 5 bianco - white
- 1040 9 nero - black

220/240v GZ10 50W max Halo  
220/240v GU10 Led



63

## ACCESSORI

Trasformatori e specifiche tecniche da pag. 213  
Transformers and technical data from page 213



# PEGASO

Design Athena

Faretto incasso orientabile. Corpo in metallo.

Adjustable recessed metal downlight.

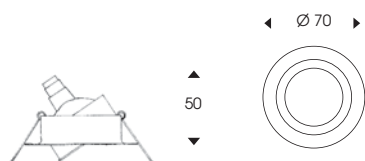

**1011 1** cromo - *chrome*

**1011 2** nichel satinato - *nickel*

**1011 3** oro zecchino - *gold*

**1011 5** bianco - *white*

**1011 9** nero - *black*

12v G4 35W max



CE IP 20



55

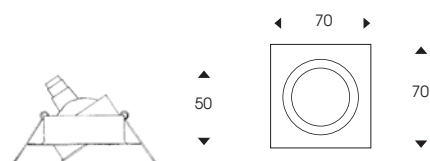

**1041 1** cromo - *chrome*

**1041 2** nichel satinato - *nickel*

**1041 3** oro zecchino - *gold*

**1041 5** bianco - *white*

**1041 9** nero - *black*

12v G4 35W max



CE IP 20



55

## ACCESSORI

Trasformatori e specifiche tecniche da pag. 213  
Transformers and technical data from page 213







204  
DRIVERS



211  
LAMPADINE



208  
CENTRALINE











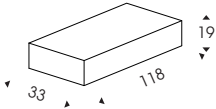



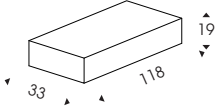



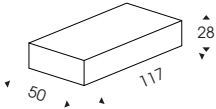



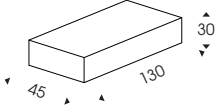

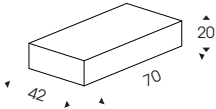

213  
TRASFORMATORI

## DRIVER CLASSE II

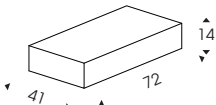
Alimentatori elettronici per power led 140-240-350-500-700 mA - Collegamento in serie.

Electronic drivers for power led 140-240-350-500-700 mA - Serial connection.

	<b>1261</b>	<b>OUTPUT</b> 140mA 45V max 6W		CE IP 20   
	<b>1263</b>	<b>OUTPUT</b> 240mA 45V max 10W		CE IP 20   
	<b>1170</b>	<b>OUTPUT</b> 350mA 45V min 3W max 15W		CE IP 20   
	<b>1179 Multipower</b>	<b>OUTPUT</b> 350mA 10/45V max 16W <b>OUTPUT</b> 500mA 10/45V max 22W <b>OUTPUT</b> 700mA 10/45V max 32W		CE IP 20   
	<b>1172</b>	<b>OUTPUT</b> 500mA 24V max 10W		CE IP 20   
	<b>1251</b>	<b>OUTPUT</b> 700mA 12V max 8,4W		CE IP 20   



Alimentatori elettronici per power led DIMMERABILI con push 350-500-700 mA - Collegamento led in serie.

Dimmable electronic driver for power led 350-500-700 mA - Serial Connection.

	<b>1177 Multipower</b>	<b>OUTPUT</b> 350mA 43V max 15W <b>OUTPUT</b> 500mA 43V max 22W <b>OUTPUT</b> 700mA 36V max 25W		CE IP 20    foro Ø 70
	<b>11749</b>	Cavetto di sincronizzazione per 1177 - lunghezza mm1500 <i>Synchronization cable for 1177- Length mm 1500</i>		
	<b>1178 Multipower</b>	<b>OUTPUT</b> 350mA 43V max 15W <b>OUTPUT</b> 500mA 36V max 20W <b>OUTPUT</b> 700mA 29V max 20W Sincronizzazione automatica con push - max 4 pezzi <i>Automatic synchro with push - max 4 pieces</i>		CE IP 20    foro Ø 55

Alimentatori elettronici per power led 350-700 mA - Collegamento in serie - IP67- Collegamento led in serie.

Electronic drivers for power led 350-700 mA - Serial connection - IP67.

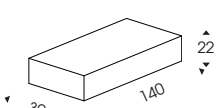
	<b>1258</b>	<b>OUTPUT</b> 350mA 48V min 3W max 15W		CE IP 20   
	<b>1259</b>	<b>OUTPUT</b> 700mA 25V min 7W max 15W		CE IP 20   











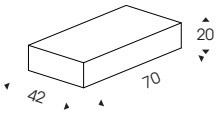



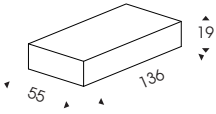



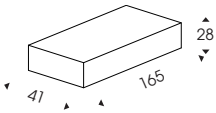



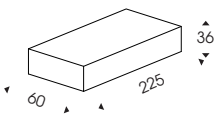

Schemi tecnici e di installazione da pag. 214

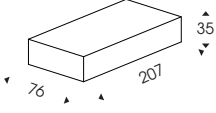
Assembly schemes from page 214

## DRIVER 24V<sub>DC</sub> CLASSE II

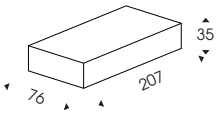
Alimentatori elettronici per led 24Vdc - Collegamento led in parallelo.











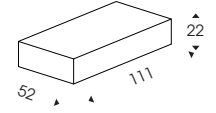

Electronic driver for led 24 Vdc - Parallel connection.

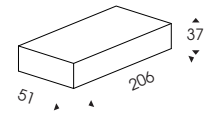
	<b>1172</b>	<b>max 10W</b>	<b>VOLT DC24</b>		<b>CE IP 20</b>   
	<b>1183</b>	<b>max 20W</b>	<b>VOLT DC24</b>		<b>CE IP 20</b>   
	<b>1195</b>	<b>max 30W</b>	<b>VOLT DC24</b>		<b>CE IP 20</b>    foro Ø 48
	<b>1184</b>	<b>max 70W</b>	<b>VOLT DC24</b>		<b>CE IP 20</b>   
	<b>1182</b>	<b>max 100W</b>	<b>VOLT DC24</b>		<b>CE IP 20</b>   
	<b>1185</b>	<b>max 150W</b>	<b>VOLT DC24</b>		<b>CE IP 20</b>   

## DRIVER DIMMERABILI 24V<sub>DC</sub> CLASSE II CON PUSH

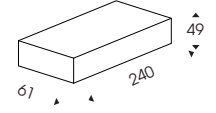
Alimentatori elettronici dimmerabili per power led 24Vdc - Collegamento led in parallelo.

Electronic drivers dimmable for led 24 Vdc - Parallel connection.

	<b>1178</b>	<b>1..10v &amp; PUSH</b> <b>max 20W</b>	<b>VOLT DC24</b>		<b>CE IP 20</b>    foro Ø 55
	<b>1186</b>	<b>1..10v &amp; PUSH e per potenziometro 470K</b> <b>max 60W</b>	<b>VOLT DC24</b>		<b>CE IP 20</b>   
	<b>1196</b>	<b>1..10v &amp; PUSH</b> <b>max 100W</b>	<b>VOLT DC24</b>		<b>CE IP 20</b>   
	<b>11969</b>	Cavetto di sincronizzazione per 1196 - Lunghezza mm 1500 <i>Synchronization cable for 1196 - length mm 1500</i>			

Schemi tecnici e di installazione da pag. 214 - Assembly schemes from page 214











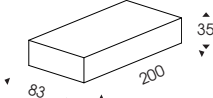

Per la scelta degli alimentatori, dopo aver calcolato l'assorbimento totale degli apparecchi da installare, aggiungere circa il 10/15 % di margine in più.

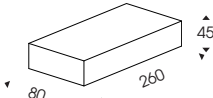
For the choice of drivers, after calculating the total absorption of the equipment to install, add about 10/15 % power more.

## DRIVER 24V<sub>DC</sub>

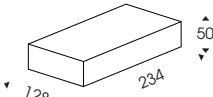









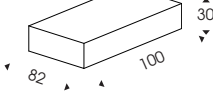



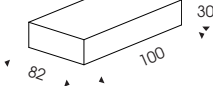



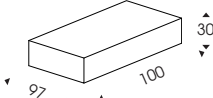







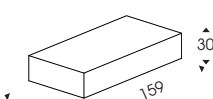

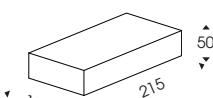

Contenitori grigi o bianchi in metallo completi di alimentatori elettronici per Led 24Vdc - Collegamento led in parallelo.

Grey or white metal boxes with electronic drivers for 24Vdc led. Parallel led connection.

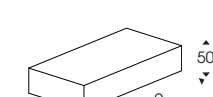
	<b>1187 5</b> bianco - white	<b>max 20W</b>	<b>VOLT DC24</b>		<b>CE IP 20</b>  
	<b>1187 7</b> grigio - grey	<b>max 20W</b>	<b>VOLT DC24</b>		
	<b>1197 5</b> bianco - white	<b>max 30W</b>	<b>VOLT DC24</b>		
	<b>1197 7</b> grigio - grey	<b>max 30W</b>	<b>VOLT DC24</b>		
	<b>1188 5</b> bianco - white	<b>max 70W</b>	<b>VOLT DC24</b>		<b>CE IP 20</b>  
	<b>1188 7</b> grigio - grey	<b>max 70W</b>	<b>VOLT DC24</b>		
	<b>1253 5</b> bianco - white	<b>max 100W</b>	<b>VOLT DC24</b>		<b>CE IP 20</b>  
	<b>1253 7</b> grigio - grey	<b>max 100W</b>	<b>VOLT DC24</b>		
	<b>1254 5</b> bianco - white	<b>max 150W</b>	<b>VOLT DC24</b>		<b>CE IP 20</b>  
	<b>1254 7</b> grigio - grey	<b>max 150W</b>	<b>VOLT DC24</b>		

Alimentatori elettronici in metallo 24Vdc per Led. Collegamento led in parallelo.

Electronic metal drivers 24Vdc. Parallel Led connection.

	<b>1252</b>	<b>max 35W</b>	<b>VOLT DC24</b>		<b>CE IP 20</b>  
	Installare in adeguati contenitori - <i>Install in appropriate cases</i>				
	<b>1189</b>	<b>max 50W</b>	<b>VOLT DC24</b>		<b>CE IP 20</b>  
	Installare in adeguati contenitori - <i>Install in appropriate cases</i>				
	<b>1190</b>	<b>max 75W</b>	<b>VOLT DC24</b>		<b>CE IP 20</b>  
	Installare in adeguati contenitori - <i>Install in appropriate cases</i>				
	<b>1191</b>	<b>max 100W</b>	<b>VOLT DC24</b>		<b>CE IP 20</b>  
	Installare in adeguati contenitori - <i>Install in appropriate cases</i>				
	<b>1192</b>	<b>max 150W</b>	<b>VOLT DC24</b>		<b>CE IP 20</b>  
	Installare in adeguati contenitori - <i>Install in appropriate cases</i>				
	<b>1198</b>	<b>max 200W</b>	<b>VOLT DC24</b>		<b>CE IP 20</b>  
	Installare in adeguati contenitori - <i>Install in appropriate cases</i>				
	<b>1193</b>	<b>max 240W</b>	<b>VOLT DC24</b>		<b>CE IP 20</b>  
	Installare in adeguati contenitori - <i>Install in appropriate cases</i> Raffreddamento a ventola - <i>Fan cooling system</i> Potrebbe dare un leggero ronzio - <i>Could be slightly noisy</i>				
	<b>1194</b>	<b>max 320W</b>	<b>VOLT DC24</b>		<b>CE IP 20</b>  
	Installare in adeguati contenitori - <i>Install in appropriate cases</i> Raffreddamento a ventola - <i>Fan cooling system</i> Potrebbe dare un leggero ronzio - <i>Could be slightly noisy</i>				

Schema tecnici e di installazione da pag. 214 - *Assembly schemes from page 214*









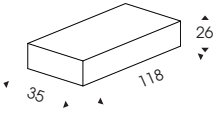

Per la scelta degli alimentatori, dopo aver calcolato l'assorbimento totale degli apparecchi da installare, aggiungere circa il 10/15 % di margine in più.

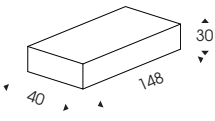
For the choice of drivers, after calculating the total absorption of the equipment to install, add about 10/15% power more.

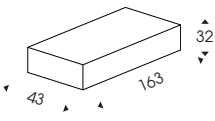
## DRIVER 24V<sub>DC</sub> IP67

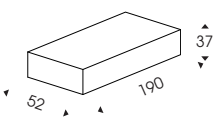
Alimentatori elettronici per led supplies 24Vdc - Collegamento led in parallelo.

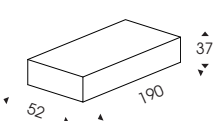

Electronic driver for led supplies 24 Vdc - Parallel LED connection.

	1240	max 20W	VOLT DC24		CE IP 67 
	1241	max 35W	VOLT DC24		CE IP 67 
	1242	max 60W	VOLT DC24		CE IP 67 
	1243	max 100W	VOLT DC24		CE IP 67 
	1245	max 150W	VOLT DC24		CE IP 67 

## UNITÀ EMERGENZA

Unità di emergenza (1 h) da utilizzare con alimentatori adeguati.

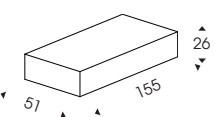
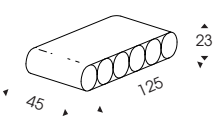
Emergency unit (1h). Use with appropriate drivers.

	1250	N° LED 6 $V_f$ 3,7 N° LED 12 $V_f$ 3,7 N° LED 18 $V_f$ 3,2 24Vdc 30W	Posizione switch B Posizione switch C Posizione switch D Posizione switch B			CE  IP 20 
-------------------------------------------------------------------------------------	------	-------------------------------------------------------------------------------	--------------------------------------------------------------------------------------	--------------------------------------------------------------------------------------	---------------------------------------------------------------------------------------	--------------------------------------------------------------------------------------------------------------------------------------------------------------------------------------

Schemi tecnici e di installazione da pag. 214 - Assembly schemes from page 214

Per la scelta degli alimentatori, dopo aver calcolato l'assorbimento totale degli apparecchi da installare, aggiungere circa il 10/15 % di margine in più.











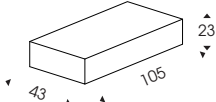

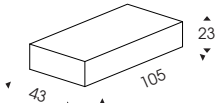

For the choice of drivers, after calculating the total absorption of the equipment to install, add about 10/15% power more.

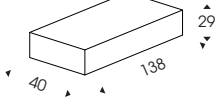

## CENTRALINE PER RGB

Centralina elettronica RGB per led 24Vdc da utilizzare con alimentatori 24Vdc - gestita con telecomando o push.

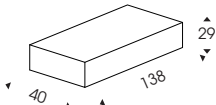
*Electronic control unit RGB for led 24Vdc to be used with 24Vdc power supply units. Remote or push controlled.*

	<b>1210</b>	Centralina controllo led RGB 24Vdc 3 canali 2,5A - 60W per canale. MAX <b>180W</b> Con telecomando infrarossi e ricevitore		CE IP 20  
	<b>1211</b>	Amplificatore segnale RGB 24Vdc per 1210 3 canali 2,5A - 60W per canale. MAX <b>180W</b> Con cavetto di sincronizzazione cm 90. Massimo 3 amplif.		CE IP 20  
	<b>1225</b>	Centralina controllo led RGB 24Vdc 3 canali 3,3A-80W per canale MAX <b>240W</b> Con telecomando radio frequenza		CE IP 20  
	<b>1262</b>	Amplificatore segnale RGB 24Vdc per 1225 3 canali 3,3A-80W per canale MAX <b>240W</b>		CE IP 20  

## CENTRALINE PER RGB - RGB/WHITE

Centralina elettronica **EXTRACEE** RGB per led 24Vdc da utilizzare con alimentatori 24Vdc - gestita con telecomando.



*EXTRACEE electronic driver unit RGB for led 24Vdc. Use with drivers 24 Vdc - Remote controlled.*

	<b>1227</b>	Centralina controllo led RGB - RGB/W 24Vdc 4 canali 3A-72W per canale MAX <b>288W</b> Con telecomando radio frequenza		CE IP 20  
	<b>1267</b>	Amplificatore segnale RGB - RGB/W 24Vdc 4 canali 3A-72W per canale MAX <b>288W</b>		CE IP 20  

## CONVERTITORE

Convertitore led da 24Vdc a 350mA da utilizzare con alimentatore tensione costante 24Vdc e/o centraline RGB.

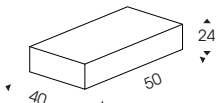
*Power LED converter from 24Vdc to 350mA. Use with drivers 24Vdc and/or RGB control unit.*

	<b>1218</b>	Input 24 Vdc output 350mA 2 tritici (6 led) Full colour RGB 350 mA 6 tritici (18 led) Monocromatici RGB 350 mA		CE IP 20  
-------------------------------------------------------------------------------------	-------------	----------------------------------------------------------------------------------------------------------------------	--------------------------------------------------------------------------------------	--------------------------------------------------------------------------------------------------------------------------------------------------------------------------------------

## ALIMENTATORI/CENTRALINE PER RGB

Centralina elettronica RGB **completa di alimentatore** max 120W per led 24Vdc - gestita con push.

*Electronic driver/control unit for led RGB 24Vdc - max 120W. Push controlled.*



- 1196** Alimentatore centralina controllo led RGB 24Vdc  
**MASTER SLAVE 24VDC MAX 120W**  
 Con 1 o più pulsanti (non compresi).  
 3 canali 1,65A-40W per canale MAX 120W  
 Con 1 o più pulsanti (non compresi)

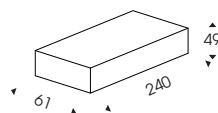

CE IP 20

Ingresso DMX con funzione auto-test incorporato e led di spegnimento. Uscite 3x12/24 V PW/M  
*Input DMX with integrated auto-test function and switching off led. Output 3x12/24 V PW/M*

- 11969** Cavetto di sincronizzazione per 1196 - Lunghezza mm 1500  
 Synchronization cable for 1196 - length mm 1500

Centralina elettronica RGB - RGB/WHITE **completa di alimentatore** max 96W per power led 24Vdc - gestita con Dmx - Dali - Push

*Electronic driver/control unit for RGB - RGB/WHITE 24Vdc - max 96w. Dmx - Dali - Push controlled.*



- 1228** Alimentatore centralina controllo led RGB - RGB/White 24Vdc  
 RGB 3 canali 1,38A-33W per canale MAX **96W**  
 RGB/W 4 canali 1,04A-24W per canale MAX **96W**

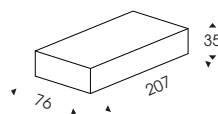

CE IP 20   
 foro Ø 80

## CENTRALINE PER RGB PER POWER LED 350mA

Centralina elettronica RGB per power led 350mA da utilizzare con alimentatori 24Vdc.

*Electronic RGB control unit for power led 350mA. Use with drivers 24Vdc.*



**N° LED 6x3Canali**      **V IN DC24**      **I OUT DC350mA**

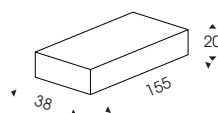

CE IP 20

- 1219** Centralina elettronica MASTER RGB power led 350mA 2 tritici full colour. Con telecomando e ricevitore.  
**1220** Centralina elettronica SLAVE RGB power led 350mA. 2 tritici full colour. Max 10 slave. Con cavetto sincronizzatore mm2000.

Uscita in corrente costante  
*Output in direct current*

## CENTRALINE PER GESTIONE DYNAMIC WHITE

Centralina elettronica DYNAMIC WHITE (variazione da warm white a cold white) per led 24Vdc da utilizzare con alimentatori 24Vdc - gestita con telecomando.

*Electronic control unit DYNAMIC WHITE (from warm white to cold white) for led 24Vdc to be used with 24Vdc power supply units - Remote controlled.*



**1229** Centralina controllo led DYNAMIC WHITE 24Vdc  
2 canali 5A-120W per canale MAX **240W**  
Con telecomando radio frequenza

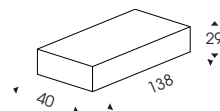

CE IP 20



**1262** Amplificatore segnale 24Vdc  
3 canali 3,3A-80W per canale MAX **240W**

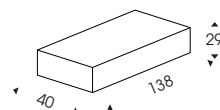

CE IP 20

Centralina elettronica **EXTRA CEE** DYNAMIC WHITE (variazione da warm white a cold white) per led 24Vdc da utilizzare con alimentatori 24Vdc - gestita con telecomando.

*Electronic control unit EXTRA CEE DYNAMIC WHITE (from warm white to cold white) for led 24Vdc to be used with 24Vdc power supply units - Remote controlled.*



**1230** Centralina controllo led DYNAMIC WHITE 24Vdc  
2 canali 5A-120W per canale MAX **240W**  
Con telecomando radio frequenza

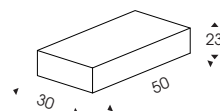

CE IP 20

## CENTRALINE ON/OFF DIMMER

Centralina elettronica ON/OFF DIMMER per led 24Vdc da utilizzare con alimentatori 24Vdc.

*Electronic control unit ON/OFF DIMMER for led 24Vdc to be used with 24Vdc power supply units.*



**1260** Centralina ON/OFF DIMMER 24Vdc  
3 canali 3,3A-80W per canale MAX **240W**  
Gestione DALI/PUSH

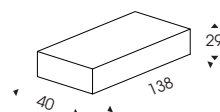

CE IP 20



**1226** Centralina ON/OFF DIMMER 24Vdc  
3 canali 3,3A-80W per canale MAX **240W**  
Con telecomando radio frequenza

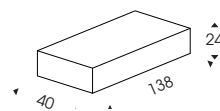

CE IP 20



**1262** Amplificatore segnale 24Vdc per 1260 e 1226  
3 canali 3,3A-80W per canale MAX **240W**

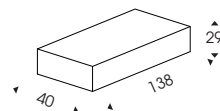

CE IP 20

## CENTRALINE PER RGB IN DMX512

Centralina elettronica RGB per led 24Vdc in DMX 512 da utilizzare con alimentatori 24Vdc.

*Electronic RGB control unit for led 24Vdc in DMX 512. Use with drivers 24Vdc.*



**1215** Centralina controllo led RGB 24Vdc  
DMX512 MASTER 24VDC 4A per canale MAX **280W**  
Con telecomando radio frequenza

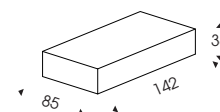

CE IP 20



**1216** Centralina controllo led RGB 24Vdc  
DMX512 SLAVE 24VDC 4A per canale MAX **280W**  
Con cavetto di sincronizzazione cm 90. Funzionamento con protocollo DMX512 o su richiesta con pulsante (non fornito).

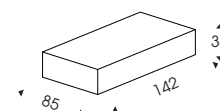









CE IP 20

# LAMPADINE LED







## Lampadine led

Led bulbs

	CODICE	CODICE	CODICE
	■ 1 Natural white 4000°K 600 lm		■ 6 Warm white 3000°K 540 lm
	Lampadina 1x6,6w 350mA H65 18°	296002006001A	296002006001G
	Lampadina 1x6,6w 350mA H65 38°	296002006002A	296002006002G
Lampadina 1x6,6w 350mA H65 54°	296002006003A	296002006003G	
	■ 1 Natural white 4000°K 810 lm		■ 6 Warm white 3000°K 740 lm
	Lampadina 1x9,8w 350mA H95 18°	296002007001A	296002007001G
	Lampadina 1x9,8w 350mA H95 38°	296002007002A	296002007002G
Lampadina 1x9,8w 350mA H95 54°	296002007003A	296002007003G	
	Lampadina trittico D.35 350mA 20°/24°	296001031001A	296001031001X
	Lampadina trittico D.35 350mA 35°/40°	296001031002A	296001031002X
	■ 9 RGB		
	Lampadina trittico D.50 H81 RGB full colour 35°/40°	296001001002D	
			■ 6 Warm white 3000°K 1250 lm
	Lampadina AR111 220-240V 15,5W 40°		281001002028
			■ 6 Warm white 3000°K 800 lm
	Lampadina AR111 G53 12V 10,5W 40°		281001002027
	■ 1 White 4000°K 430 lm		■ 6 Warm white 3000°K 400 lm
	Lampadina LED 230V GU10 6W 60°	296002004001A	296002004001G
	■ 1 White 4000°K 430 lm		■ 6 Warm white 3000°K 400 lm
	Lampadina LED 12V G 5,3 6W 60°	296002005001A	296002005001G

Utilizzare solo trasformatori toroidali - Use only toroidal transformer

## LAMPADINE

	DESCRIZIONE	CODICE
	Fluorescente neon T5 24W/840	299002190001
	Fluorescente neon T5 39W/840	299002190002
	Fluorescente neon T5 54W/840	299002190003
	Fluorescente neon T5 24W/830	299002190001C
	Fluorescente neon T5 39W/830	299002190002C
	Fluorescente neon T5 54W/830	299002190003C
	Alogena bispina ECO 7W 2800°K	297016000001
	Alogena bispina ECO 14W 2800°K	297016000002
	Alogena bispina ECO 35W 28000°K	297016000004
	Alogena dicroica diam 35 G4 20W con vetro 38°	298002010001
	Alogena dicroica diam 35 G4 35W con vetro 30°	298002010002
	Alogena dicroica diam.50 G5,3 20W con vetro 60°	298001010001
	Alogena dicroica diam.50 G5,3 35W con vetro 60°	298001010002
	Alogena dicroica diam.50 G5,3 50W con vetro 60°	298001010003
	Alogena GZ10 230V 50W 50°	298009000002
	Halopin ECO G9 20W smerigl. 230V 2700°K	297002000004
	Halopin ECO G9 33W smerigl. 230V 2700°K	297002000001
	Halopin ECO G9 48W smerigl. 230V 2800°K	297002000002
	Lineare ECO mm.117 R7S 160W	297003000011

## CAVI E CONNETTORI

Cavi per connessione Led e alimentatori

Cables for led and drivers connections

					<b>CODICE</b>
		Morsetto per congiunzione IP67 1,5 mq			201006000001
<b>GUAINE</b>					<b>CODICE</b>
	Guaina bianca termorestringente mm 9 ris 3:1				205004000015
<b>CAVI</b>	<b>SEZIONE</b>	<b>MISURE</b>	<b>TEMPERATURA DI IMPIEGO</b>	<b>CODICE</b>	
PVC+FEP Trasparente Polarizzati riga bianca, rossa, nera	mm2 4x0,50	mm 4,8Ø	T180/105°	205007000048	
PVC+FEP Trasparente Polarizzati riga bianca	mm2 2xAVG22	mm 3,6Ø	T180/105°	205007000045	
Unipolare FEP-rosso	mm2 AVG22		T180°	205007000046	
Unipolare FEP-nero	mm2 AVG22		T180°	205007000047	
PVC Flat quadripolare RGB	mm2 AVG22	mm 5,4x1,4	T90°	205007000050	
Cavo FROR grigio 2x0,75	mm2 AVG22		T180°	205003000020	
Cavo SEZ 4x0,50 x LED RGB			T180°	205003000023	
Cavo SEZ 6x0,35 x LED RGB			T180°	205003000024	

# TRASFORMATORI

## Trasformatori elettronici dimmerabili (regolazione IGBT)

Dimmerable electronic transformer (trailing edge-leading edge).



**203001012003R 150W** 75÷150 12V



CE IP 20  

**203001012004R 250W** 100÷250 12V

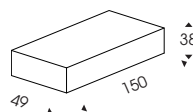

CE IP 20  

## Trasformatori elettronici per LED e ALOGENA

Electronic transformer for Led and Halo

**299002170004 12V**

Alogena da 2,5 a 70W

Led da 2,5 a 50W (max 4/5 lampade)

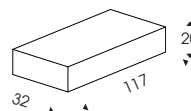

CE IP 20  

foro Ø 40

## Trasformatori toroidali compatti

Compact toroidal transformers



**203003022001 50W** 12V

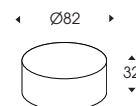

CE IP 20 

**203002022003 100W** 12V

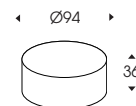

CE IP 20 

**203002022005 200W** 12V

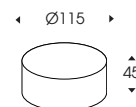

CE IP 20 

**203002022004 300W** 12V

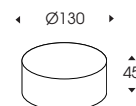

CE IP 20 

**203002022006 400W** 12V

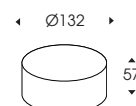

CE IP 20 

# COLLEGAMENTI

1261	140mA max 6W
1263	240mA max 10W
1170	350mA max 15W
1172	500mA max 10W
1251	700mA max 8,4W

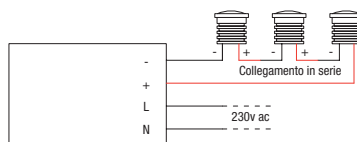

1179	350mA max 16W
	500mA max 22W
	700mA max 32W

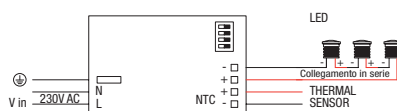

1177	Dimmerabile Push
	350mA max 12W
	500mA max 22W
	700mA max 25W

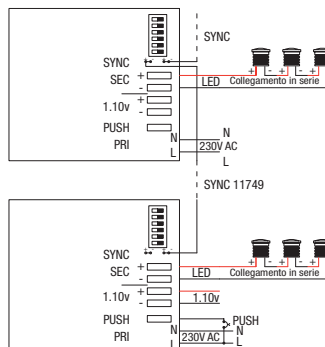

1178	Dimmerabile Push
	350mA max 15W
	500mA max 20W
	700mA max 20W
	24Vdc max 20W

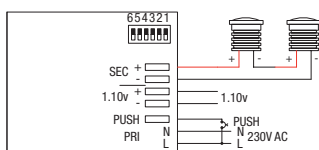

FINO A 4 PEZZI  
MAX IN SINCRO

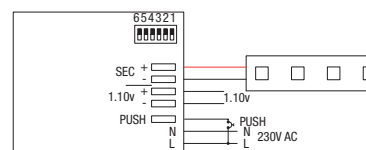

24V 20W  
FINO A 4 PEZZI MAX IN SINCRO

1186	Alimentatore dimmerabile push o 1-10V 24Vdc max 60W
------	-----------------------------------------------------

**MASTER**  
Jumper ON

**SLAVE**  
NO Jumper

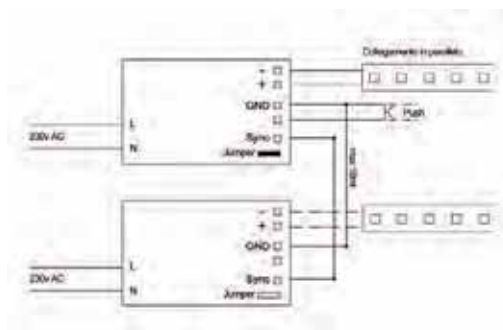

Massimo n° 9 Slave

## COLLEGAMENTI

1196 Centralina/Alimentatore RGB controllata con PUSH o 1-10V (max 120W)

MASTER  
NO Jumper

SLAVE  
Jumper ON  
(Max 9 pezzi)

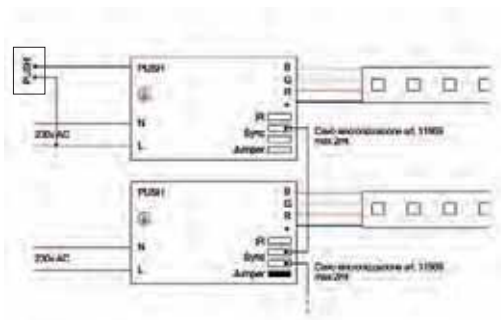

1196 Centralina/Alimentatore RGB controllata con PUSH o 1-10V (max 120W) + converter (art. 1218)

MASTER  
NO Jumper

SLAVE  
Jumper ON  
(Max 9 pezzi)

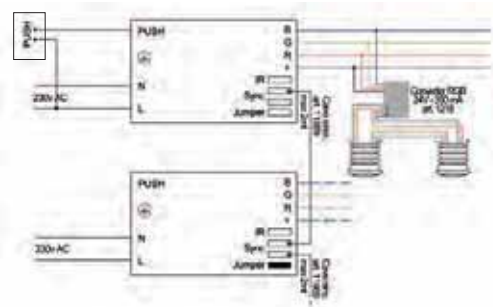

1196 Alimentatore dimmerabile PUSH o 1-10V (max 100W) - Esempio collegamento con strip monocromatica.

MASTER  
Jumper ON

SLAVE  
Jumper ON  
(Max 9 pezzi)

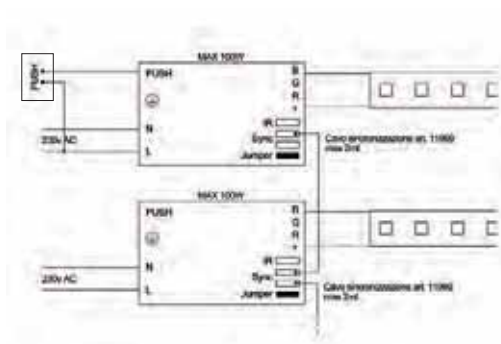



## COLLEGAMENTI

**1210-1211** Centralina RGB controllata con push o telecomando da alimentare 24Vdc (max 150W)

**1210**  
MASTER  
Jumper ON

**1211**  
SLAVE  
NO Jumper  
(max 3 pezzi)

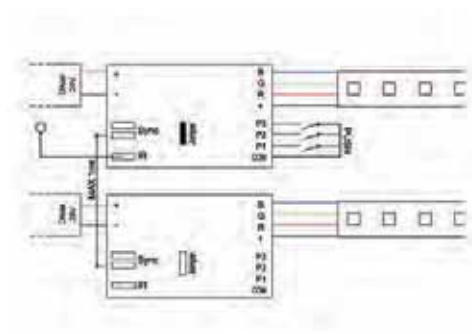

**1210-1211** Centralina RGB controllata con push o telecomando da alimentare 24Vdc (max 150W) + converter (art. 1218)

**1210**  
MASTER  
Jumper ON

**1211**  
SLAVE  
NO Jumper  
(max 3 pezzi)

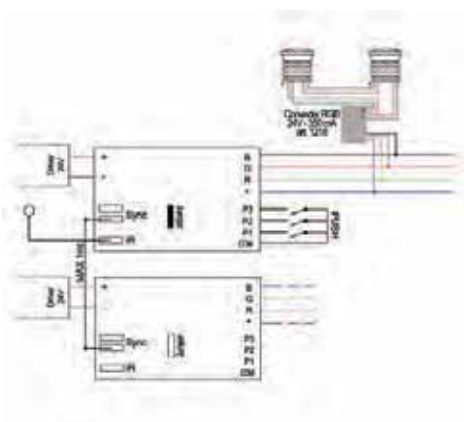

# COLLEGAMENTI

**1225-1262** Centralina RGB controllata con telecomando radiofrequenza da alimentare 24Vdc (max 240W)

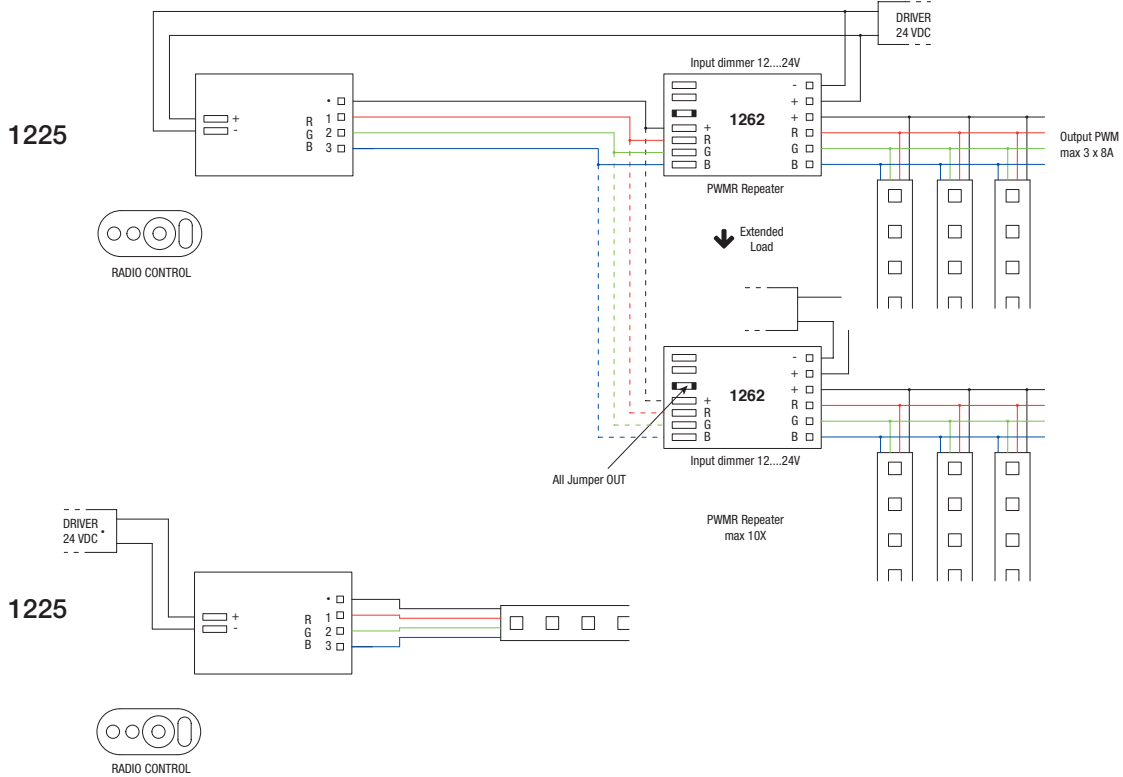

**1227-1267** Centralina elettronica RGB/RGB W - gestita con telecomando, da alimentare 24Vdc

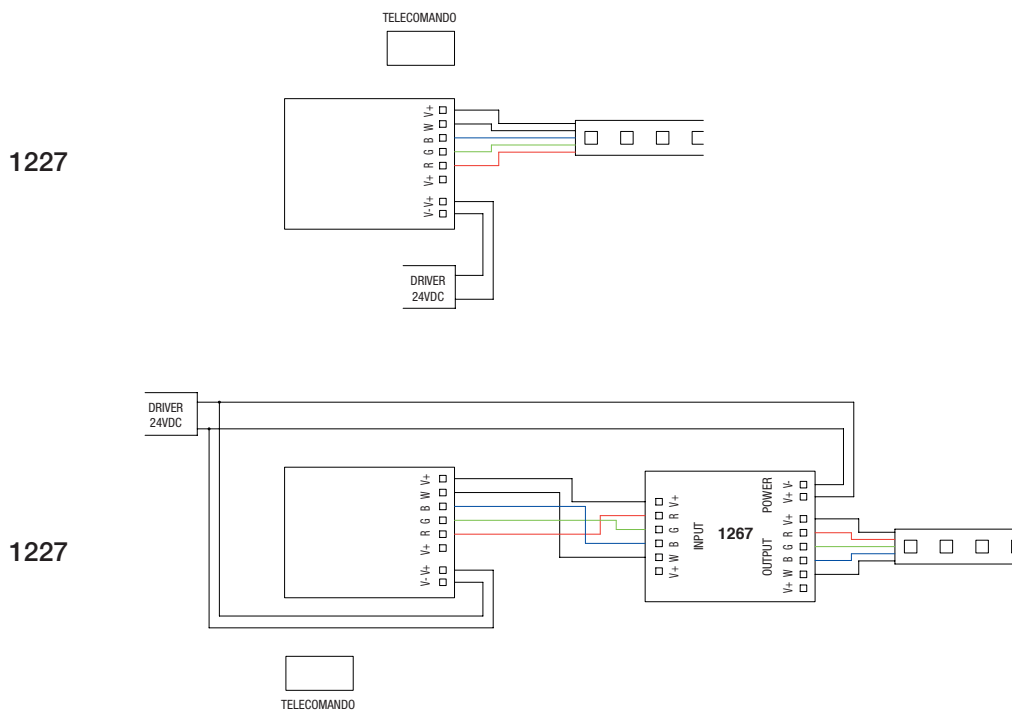

# COLLEGAMENTI

1228 Centralina completa di alimentatore

Gestione  
PUSH  
(RGB/RGBW)

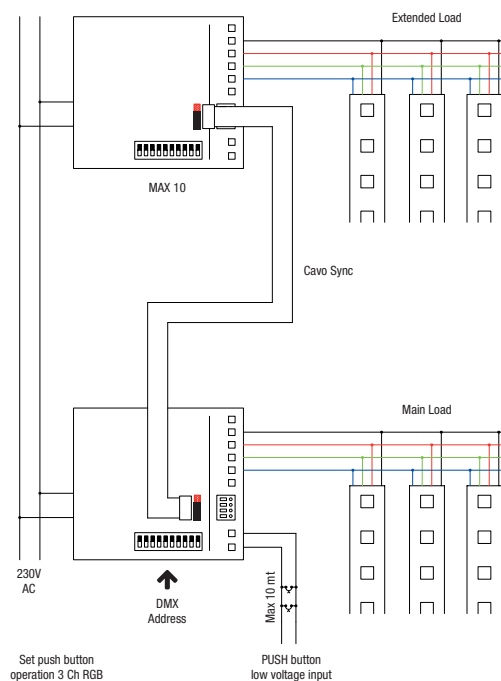

1228 Centralina completa di alimentatore

Gestione  
DALI

RGBW

RGB

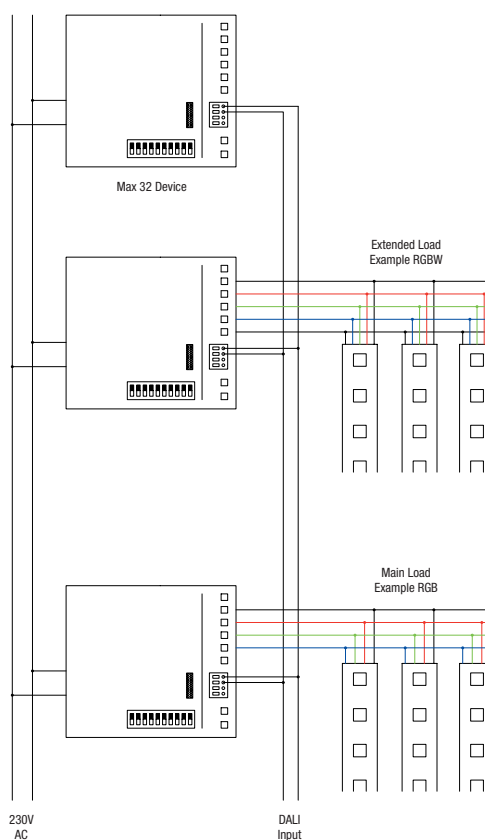

## COLLEGAMENTI

1228

Centralina completa di alimentatore

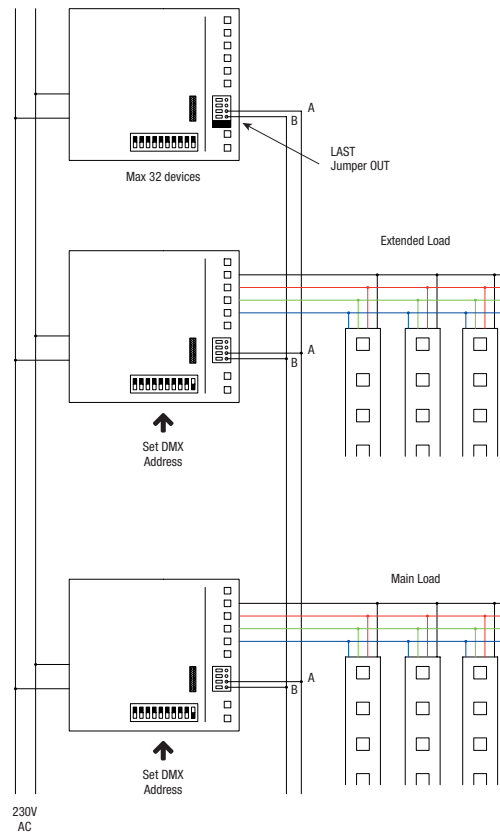
Gestione  
DMX RGB

1228

Centralina completa di alimentatore

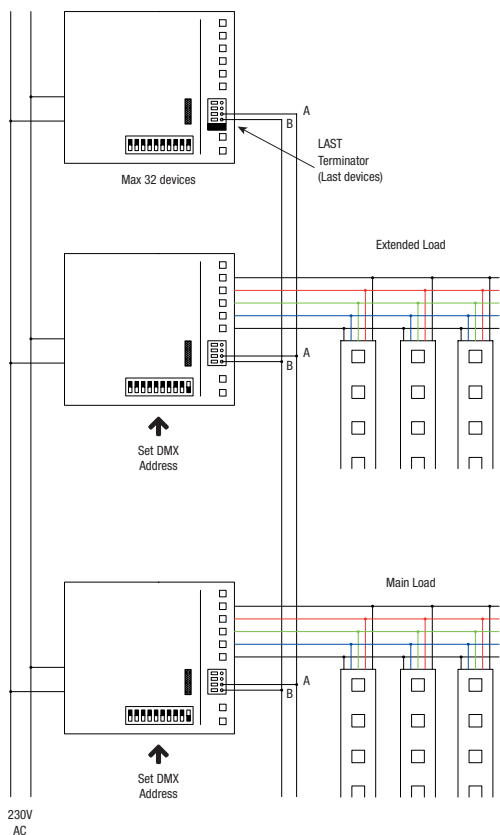
Gestione  
DMX RGB/RGBW

## COLLEGAMENTI

1219-1220 Centralina per RGB per power led 350mA, da alimentare 24Vdc

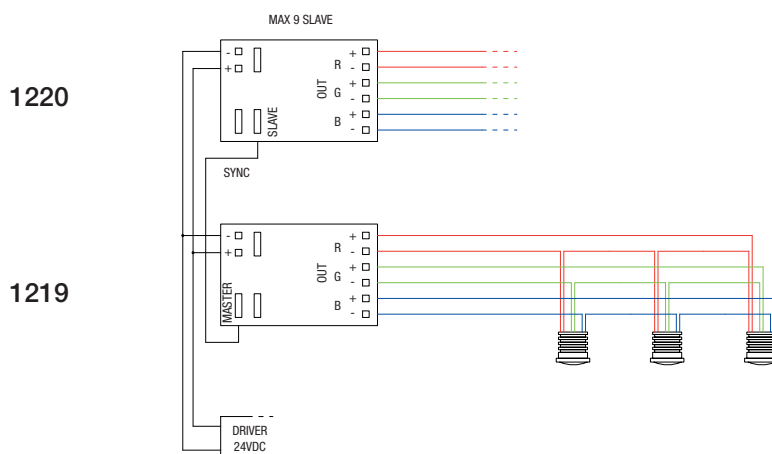

1229-1262 Centralina Dynamic White controllata con telecomando radiofrequenza da alimentare 24Vdc (max 240W)

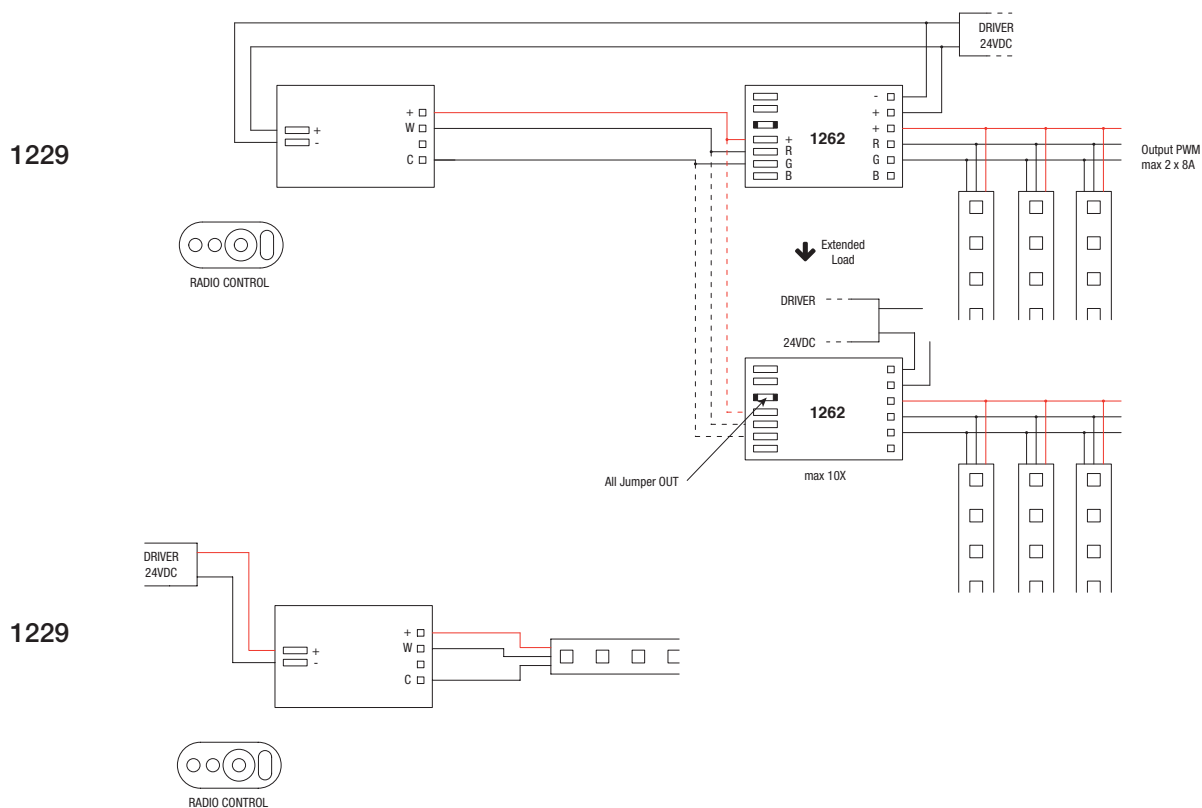

## COLLEGAMENTI

1230 Centralina per Dynamic White, da alimentare 24Vdc

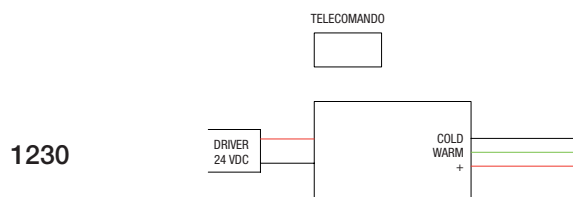

1260-1262 Centralina On-Off dimmer controllato con Dali - Push da alimentare 24Vdc (max 240W)

1260

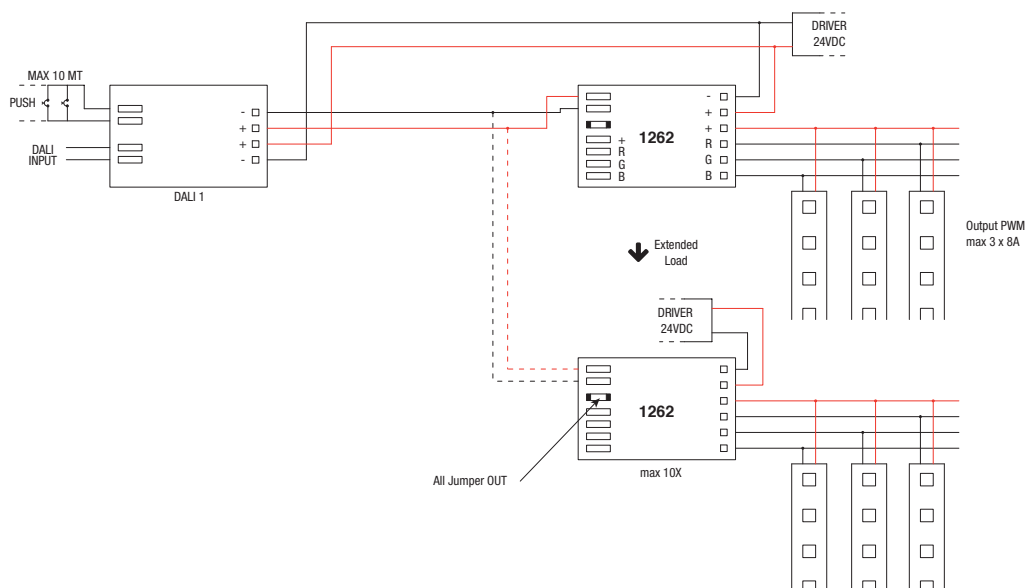

1260

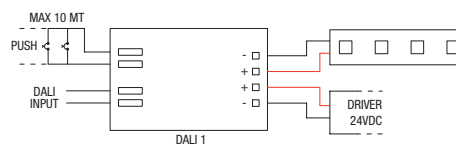



# INDICE E CODICI

Design Athena

Cod.	Collezione	Pag.	Cod.	Collezione	Pag.	Cod.	Collezione	Pag.
0100	Focus1	pag. 75	0242	Focus300	pag. 59	035856	Twin	pag. 80
0102	Focus1	pag. 75	0243	Focus300	pag. 58	0434	Focus160	pag. 70
0103	Focus1	pag. 75	0251	Focus300	pag. 60	045751	Focus160	pag. 66
0106	Focus1	pag. 75	0253	Focus	pag. 77	045756	Focus160	pag. 66
0108	Focus1	pag. 75	0254	Focus300	pag. 56	045856	Focus160	pag. 68
0109	Focus1	pag. 75	0255	Focus	pag. 77	0472	Focus160	pag. 70
0110	Focus1	pag. 75	025671	Focus	pag. 77	049051	Focus160	pag. 69
0134	Focus1	pag. 73	025676	Focus	pag. 77	049056	Focus160	pag. 69
0139	Focus1	pag. 74	025771	Focus	pag. 77	049071	Focus160	pag. 69
0154	Focus1	pag. 74	025776	Focus	pag. 77	049076	Focus160	pag. 69
0172	Focus1	pag. 72	0272	Focus300	pag. 62	049091	Focus160	pag. 69
019051	Focus1	pag. 73	0282	Focus300	pag. 62	049096	Focus160	pag. 69
019056	Focus1	pag. 73	028951	Focus300	pag. 52	0529	Flight	pag. 98
019071	Focus1	pag. 73	028956	Focus300	pag. 52	0530	Flight	pag. 98
019076	Focus1	pag. 73	028991	Focus300	pag. 52	0531	Flight	pag. 98
019091	Focus1	pag. 73	028996	Focus300	pag. 52	0532	Flight	pag. 98
019096	Focus1	pag. 73	029051	Focus300	pag. 54	0533	Flight	pag. 98
019171	Focus1	pag. 74	029056	Focus300	pag. 54	0534	Flight	pag. 98
019176	Focus1	pag. 74	029071	Focus300	pag. 54	0535	Flight	pag. 98
019271	Focus1	pag. 74	029076	Focus300	pag. 54	0539	Flight	pag. 98
019276	Focus1	pag. 74	029091	Focus300	pag. 54	0540	Flight	pag. 98
0200	Focus300-160	pag. 65	029096	Focus300	pag. 54	0541	Flight	pag. 98
0202	Focus300-160	pag. 65	029171	Focus300	pag. 55	0542	Flight	pag. 98
0203	Focus300-160-Twin	pag. 65	029176	Focus300	pag. 55	0543	Flight	pag. 98
0204	Focus300-160	pag. 65	029271	Focus300	pag. 55	0544	Flight	pag. 98
0205	Focus300-160	pag. 65	029276	Focus300	pag. 55	0545	Flight	pag. 98
0206	Focus300-160	pag. 65	0319	Twin	pag. 95	0563	Flight	pag. 98
0207	Focus300-160-1	pag. 65	0328	Twin	pag. 95	0630	Twin - Flight	pag. 92
0208	Focus300-160-Twin	pag. 65	0329	Twin	pag. 95	0631	Twin - Flight	pag. 92
0209	Focus300-160	pag. 65	0330	Twin	pag. 95	0632	Twin - Flight	pag. 92
0210	Focus300-160	pag. 65	0331	Twin	pag. 95	0633	Twin - Flight	pag. 92
021176	Focus300	pag. 63	0335	Twin	pag. 95	0634	Twin - Flight	pag. 92
0212	Focus300	pag. 55	0336	Twin	pag. 95	0635	Twin - Flight	pag. 92
0213	Focus300	pag. 56	0338	Twin	pag. 95	0639	Twin - Flight	pag. 93
0214	Focus300-160	pag. 65	0339	Twin	pag. 95	0640	Twin - Flight	pag. 93
0215	Focus300	pag. 55	0340	Twin	pag. 95	0814	Flight	pag. 99
0216	Focus1	pag. 75	0341	Twin	pag. 95	0818	Flight	pag. 99
0217	Focus-1	pag. 75	0342	Twin - Flight	pag. 93	0819	Flight	pag. 99
0218	Focus-1	pag. 75	0353	Twin	pag. 84	0820	Flight	pag. 99
0221	Focus300-1	pag. 56	0354	Twin - Flight	pag. 84	0823	Twin	pag. 96
0222	Focus300-1	pag. 56	0355	Twin	pag. 84	0824	Twin	pag. 96
0234	Focus300	pag. 60	035751	Twin	pag. 82	0826	Twin	pag. 96
0239	Focus300	pag. 56	035756	Twin	pag. 82	0827	Twin	pag. 96
0240	Focus300	pag. 59	035851	Twin	pag. 80	0849	Twin	pag. 96



# INDICE E CODICI

Design Athena

Cod.	Collezione	Pag.	Cod.	Collezione	Pag.	Cod.	Collezione	Pag.
1007	Pegaso	pag. 198	11432	Orione	pag. 192	1240	Alimentatori	pag. 207
1008	Pegaso	pag. 198	11461	Orione	pag. 194	1241	Alimentatori	pag. 207
1009	Pegaso	pag. 199	11462	Orione	pag. 186	1242	Alimentatori	pag. 207
1010	Pegaso	pag. 199	11463	Orione	pag. 187	1243	Alimentatori	pag. 207
1011	Pegaso	pag. 200	11464	Orione	pag. 187	1245	Alimentatori	pag. 207
1037	Pegaso	pag. 198	11471	Orione	pag. 195	1250	Alimentatori	pag. 207
1038	Pegaso	pag. 198	11481	Orione	pag. 196	1251	Alimentatori	pag. 204
1039	Pegaso	pag. 199	11491	Orione	pag. 196	1252	Alimentatori	pag. 206
1040	Pegaso	pag. 199	1170	Alimentatori	pag. 204	1253	Alimentatori	pag. 206
1041	Pegaso	pag. 200	1172	Alimentatori	pag. 204	1254	Alimentatori	pag. 206
1130	Orione	pag. 179	1177	Alimentatori	pag. 204	1258	Alimentatori	pag. 204
11301	Orione	pag. 179	1178	Alimentatori	pag. 204	1259	Alimentatori	pag. 204
11302	Orione	pag. 180	1179	Alimentatori	pag. 204	1260	Alimentatori	pag. 210
11303	Orione	pag. 181	1182	Alimentatori	pag. 205	1261	Alimentatori	pag. 204
11304	Orione	pag. 183	1183	Alimentatori	pag. 205	1262	Alimentatori	pag. 208
11306	Orione	pag. 184	1184	Alimentatori	pag. 205	1263	Alimentatori	pag. 204
11307	Orione	pag. 185	1185	Alimentatori	pag. 205	1264	Giotto	pag. 123
1131	Orione	pag. 180	1186	Alimentatori	pag. 205	1264D	Giotto	pag. 123
11311	Orione	pag. 179	1187	Alimentatori	pag. 206	1264R	Giotto	pag. 123
11312	Orione	pag. 180	1188	Alimentatori	pag. 206	1265	Giotto	pag. 123
11313	Orione	pag. 181	1189	Alimentatori	pag. 206	1265D	Giotto	pag. 123
11314	Orione	pag. 183	1190	Alimentatori	pag. 206	1265R	Giotto	pag. 123
11316	Orione	pag. 184	1191	Alimentatori	pag. 206	1267	Alimentatori	pag. 208
1132	Orione	pag. 181	1192	Alimentatori	pag. 206	1268	Alimentatori	pag. 210
11324	Orione	pag. 183	1193	Alimentatori	pag. 206	1410	Twin	pag. 90
1133	Orione	pag. 183	1194	Alimentatori	pag. 206	1411	Flight	pag. 90
11334	Orione	pag. 183	1195	Alimentatori	pag. 205	1910	Twin	pag. 86
11342	Orione	pag. 180	1196	Alimentatori	pag. 205	1911	Flight	pag. 86
11343	Orione	pag. 181	11969	Alimentatori	pag. 205	2010	Twin	pag. 86
11344	Orione	pag. 183	1197	Alimentatori	pag. 206	2011	Flight	pag. 86
11346	Orione	pag. 184	1198	Alimentatori	pag. 206	3010	Twin	pag. 89
11347	Orione	pag. 185	1210	Alimentatori	pag. 208	3011	Flight	pag. 89
11352	Orione	pag. 180	1211	Alimentatori	pag. 208	3110	Twin	pag. 87
11353	Orione	pag. 181	1215	Alimentatori	pag. 210	3310	Twin	pag. 87
11354	Orione	pag. 183	1216	Alimentatori	pag. 210	3311	Flight	pag. 87
11356	Orione	pag. 184	1218	Alimentatori	pag. 208	3501	Faretti	pag. 173
1140	Orione	pag. 180	1219	Alimentatori	pag. 209	4101	Faretti	pag. 174
11401	Orione	pag. 189	1220	Alimentatori	pag. 209	4510	Twin	pag. 90
11402	Orione	pag. 189	1225	Alimentatori	pag. 208	4511	Flight	pag. 90
11411	Orione	pag. 190	1226	Alimentatori	pag. 210	4610	Twin	pag. 89
11412	Orione	pag. 190	1227	Alimentatori	pag. 208	4611	Flight	pag. 89
11421	Orione	pag. 191	1228	Alimentatori	pag. 209	4705	Faretti	pag. 172
11422	Orione	pag. 191	1229	Alimentatori	pag. 210	470582	Faretti	pag. 172
11431	Orione	pag. 192	1230	Alimentatori	pag. 210	470583	Faretti	pag. 172

## INDICE E CODICI

Design Athena

Cod.	Collezione	Pag.	Cod.	Collezione	Pag.	Cod.	Collezione	Pag.
470584	Faretti	pag. 172	527191	Dadajè	pag. 108	560151	Milo	pag. 115
473582	Faretti	pag. 173	527196	Dadajè	pag. 108	560156	Milo	pag. 115
473583	Faretti	pag. 173	528151	Dadajè	pag. 108	562151	Milo	pag. 116
473584	Faretti	pag. 173	528156	Dadajè	pag. 108	562156	Milo	pag. 116
474182	Faretti	pag. 174	528171	Dadajè	pag. 108	569151	Prisma	pag. 112
474183	Faretti	pag. 174	528176	Dadajè	pag. 108	569156	Prisma	pag. 112
474184	Faretti	pag. 174	528191	Dadajè	pag. 108	569171	Prisma	pag. 112
477282	Faretti	pag. 175	528196	Dadajè	pag. 108	569176	Prisma	pag. 112
477283	Faretti	pag. 175	529151	Dadajè	pag. 111	569191	Prisma	pag. 112
477284	Faretti	pag. 175	529156	Dadajè	pag. 111	569196	Prisma	pag. 112
520151	Dadajè	pag. 104	529171	Dadajè	pag. 111	570151	Milo	pag. 115
520156	Dadajè	pag. 104	529176	Dadajè	pag. 111	570156	Milo	pag. 115
520171	Dadajè	pag. 104	529191	Dadajè	pag. 111	572151	Milo	pag. 117
520176	Dadajè	pag. 104	529196	Dadajè	pag. 111	572156	Milo	pag. 117
520191	Dadajè	pag. 104	530151	Dadajè	pag. 104	5722	Arte	pag. 170
520196	Dadajè	pag. 104	530156	Dadajè	pag. 104	5831	Riflessi	pag. 151
523151	Dadajè	pag. 107	530171	Dadajè	pag. 104	5832	Riflessi	pag. 151
523156	Dadajè	pag. 107	530176	Dadajè	pag. 104	5833	Riflessi	pag. 151
523171	Dadajè	pag. 107	530191	Dadajè	pag. 104	5834	Riflessi	pag. 151
523176	Dadajè	pag. 107	530196	Dadajè	pag. 104	5841	Kite	pag. 155
523191	Dadajè	pag. 107	539151	Dadajè	pag. 111	5842	Kite	pag. 155
523196	Dadajè	pag. 107	539156	Dadajè	pag. 111	5851	Kite	pag. 152
524151	Dadajè	pag. 107	539171	Dadajè	pag. 111	5852	Kite	pag. 152
524156	Dadajè	pag. 107	539176	Dadajè	pag. 111	5858	Kite	pag. 157
524171	Dadajè	pag. 107	539191	Dadajè	pag. 111	5859	Kite	pag. 157
524176	Dadajè	pag. 107	539196	Dadajè	pag. 111	5862	Kite	pag. 156
524191	Dadajè	pag. 107	540151	Dadajè	pag. 106	5863	Kite	pag. 156
524196	Dadajè	pag. 107	540156	Dadajè	pag. 106	5880	Kite	pag. 154
525151	Dadajè	pag. 107	540171	Dadajè	pag. 106	6460	Metal Led	pag. 167
525156	Dadajè	pag. 107	540176	Dadajè	pag. 106	646016	Metal Led	pag. 167
525171	Dadajè	pag. 107	540191	Dadajè	pag. 106	646056	Metal Led	pag. 167
525176	Dadajè	pag. 107	540196	Dadajè	pag. 106	6461	Metal Led	pag. 166
525191	Dadajè	pag. 107	550151	Prisma	pag. 112	646116	Metal Led	pag. 166
525196	Dadajè	pag. 107	550156	Prisma	pag. 112	646156	Metal Led	pag. 166
526151	Dadajè	pag. 105	550171	Prisma	pag. 112	6462	Metal Led	pag. 166
526156	Dadajè	pag. 105	550176	Prisma	pag. 112	646216	Metal Led	pag. 166
526171	Dadajè	pag. 105	550191	Prisma	pag. 112	646256	Metal Led	pag. 166
526176	Dadajè	pag. 105	550196	Prisma	pag. 112	6641	Onda	pag. 161
526191	Dadajè	pag. 105	559151	Prisma	pag. 112	6642	Onda	pag. 161
526196	Dadajè	pag. 105	559156	Prisma	pag. 112	6651	Onda	pag. 160
527151	Dadajè	pag. 108	559171	Prisma	pag. 112	6652	Onda	pag. 160
527156	Dadajè	pag. 108	559176	Prisma	pag. 112	684311	Magic	pag. 159
527171	Dadajè	pag. 108	559191	Prisma	pag. 112	684361	Magic	pag. 159
527176	Dadajè	pag. 108	559196	Prisma	pag. 112	7201	Faretti	pag. 175

## INDICE E CODICI

Design Athena

Cod.	Collezione	Pag.	Cod.	Collezione	Pag.	Cod.	Collezione	Pag.
775114	Giotto	pag. 120	90219	Sigma Led2	pag. 15	91719	Tau Mov	pag. 23
775119	Giotto	pag. 120	90399	Sigma3	pag. 34	91814	Tau Touch	pag. 23
775214	Giotto	pag. 120	9047	Sigma	pag. 33	91819	Tau Touch	pag. 23
775219	Giotto	pag. 120	9048	Sigma	pag. 33	91829	Tau Touch	pag. 23
775314	Giotto	pag. 121	9049	Sigma	pag. 33	9199	Tau	pag. 38
775319	Giotto	pag. 121	9050	Sigma	pag. 33	9205	Etha	pag. 28
775414	Giotto	pag. 121	9051	Sigma	pag. 33	9210	Etha	pag. 28
775419	Giotto	pag. 121	9051195	Degas	pag. 124	9298	Etha	pag. 28
8201	Alpha	pag. 163	9051197	Degas	pag. 124	9299	Etha	pag. 28
8301	Beta	pag. 164	9051199	Degas	pag. 124	930549	Sihon	pag. 26
8401	Alpha	pag. 163	9052	Sigma	pag. 33	930550	Sihon	pag. 26
8411	Alpha	pag. 163	9052195	Degas	pag. 126	930599	Sihon	pag. 26
8430	Alpha	pag. 162	9052197	Degas	pag. 126	9314	Sihon Led	pag. 24
8501	Beta	pag. 164	9052199	Degas	pag. 126	9319	Sihon Led	pag. 24
8511	Beta	pag. 164	9053195	Degas	pag. 126	9349	Sihon	pag. 42
8530	Beta	pag. 165	9053197	Degas	pag. 126	9350	Sihon	pag. 42
8706	Arte	pag. 171	9053199	Degas	pag. 126	9352	Sihon	pag. 42
8707	Arte	pag. 171	9054195	Degas	pag. 124	9353	Sihon	pag. 26
8708	Arte	pag. 170	9054197	Degas	pag. 124	93714	Sihon Mov	pag. 25
8709	Arte	pag. 168	9054199	Degas	pag. 124	93719	Sihon Mov	pag. 25
8730	Arte	pag. 168	9055195	Degas	pag. 128	93814	Sihon Touch	pag. 25
8731	Mondrian	pag. 137	9055197	Degas	pag. 128	93819	Sihon Touch	pag. 25
8732	Mondrian	pag. 137	9055199	Degas	pag. 128	93829	Sihon Touch	pag. 25
88611	Picasso	pag. 145	9056195	Degas	pag. 129	9399	Sihon	pag. 42
88612	Picasso	pag. 145	9056197	Degas	pag. 129	9451	Kappa	pag. 40
8862119	Picasso	pag. 147	9056199	Degas	pag. 129	9452	Kappa	pag. 40
8862219	Picasso	pag. 147	9080195	Degas	pag. 130	9491	Piatto	pag. 41
8863119	Picasso	pag. 146	9080197	Degas	pag. 130	9492	Piatto	pag. 41
88632	Picasso	pag. 146	9080199	Degas	pag. 130	9499	Kappa	pag. 40
8944	Monet	pag. 142	9081195	Degas	pag. 130	9514	Omega Led	pag. 16
8945	Monet	pag. 142	9081197	Degas	pag. 130	9519	Omega Led	pag. 16
8946	Monet	pag. 142	9081199	Degas	pag. 130	9549	Omega	pag. 36
8947	Monet	pag. 143	9082195	Degas	pag. 134	9550	Omega	pag. 36
8954	Monet	pag. 140	9082197	Degas	pag. 134	95505	Omega Wet	pag. 30
8955	Monet	pag. 140	9082199	Degas	pag. 134	9551	Omega	pag. 36
8956	Monet	pag. 140	9083195	Degas	pag. 134	95510	Omega Wet	pag. 30
8957	Monet	pag. 141	9083197	Degas	pag. 134	95514	Omega Wet	pag. 30
8974	Monet	pag. 140	9083199	Degas	pag. 134	9552	Omega	pag. 36
8975	Monet	pag. 140	9099	Sigma	pag. 33	95605	Omega Wet	pag. 31
8976	Monet	pag. 141	9114	Tau Led	pag. 22	95610	Omega Wet	pag. 31
8977	Monet	pag. 141	9119	Tau Led	pag. 22	95614	Omega Wet	pag. 31
9014	Sigma Led1	pag. 13	9151	Tau	pag. 38	9599	Omega	pag. 36
9019	Sigma Led1	pag. 13	9152	Tau	pag. 38	9614	Delta Led	pag. 18
90214	Sigma Led2	pag. 15	91714	Tau Mov	pag. 23	9619	Delta Led	pag. 18

# INDICE E CODICI

Design Athena

Cod.	Collezione	Pag.	Cod.	Collezione	Pag.	Cod.	Collezione	Pag.
9649	Delta	pag. 37	9706	Strip Flex	pag. 49	97900	Strip Flex	pag. 45
9650	Delta	pag. 37	9707	Strip Flex	pag. 49	9791	Strip Flex	pag. 49
9651	Delta	pag. 37	9708	Strip Flex	pag. 49	9792	Strip Flex	pag. 49
9652	Delta	pag. 37	97101	Strip Flex	pag. 49	9794	Strip Flex	pag. 49
9653	Sigma-Omega-Delta-Sihon-Tau	pag. 33	97106	Strip Flex	pag. 49	9796	Strip Flex	pag. 49
9654	Sigma-Omega-Delta-Sihon	pag. 33	97191	Strip Flex	pag. 49	9797	Strip Flex	pag. 49
9655	Omega-Delta-Sihon	pag. 36	97196	Strip Flex	pag. 49	9798	Strip Flex	pag. 49
9656	Sigma-Delta-Tau-Sihon	pag. 33	97301	Strip Flex	pag. 48	97990	Strip Flex	pag. 45
9657	Sigma-Omega-Delta-Sihon	pag. 33	97306	Strip Flex	pag. 48	9843	Twin - Flight	pag. 92
9658	Sigma-Omega-Delta-Sihon	pag. 33	97391	Strip Flex	pag. 48	9901	Strip Flex	pag. 46
9659	Sigma	pag. 33	97396	Strip Flex	pag. 48	9906	Strip Flex	pag. 46
9660	Sigma-Omega-Delta-Sihon-Tau-Kappa	pag. 33	97401	Strip Flex	pag. 48	9909	Strip Flex	pag. 46
96714	Delta Mov	pag. 19	97406	Strip Flex	pag. 48	99101	Strip Flex	pag. 46
96719	Delta Mov	pag. 19	97491	Strip Flex	pag. 48	99106	Strip Flex	pag. 46
96814	Delta Touch	pag. 19	97496	Strip Flex	pag. 48	99109	Strip Flex	pag. 46
96819	Delta Touch	pag. 19	97601	Strip Flex	pag. 44	99191	Strip Flex	pag. 46
96829	Delta Touch	pag. 19	97606	Strip Flex	pag. 44	99196	Strip Flex	pag. 46
9699	Delta	pag. 37	97691	Strip Flex	pag. 44	99199	Strip Flex	pag. 46
9701	Strip Flex	pag. 49	97696	Strip Flex	pag. 44	9991	Strip Flex	pag. 46
9702	Strip Flex	pag. 49	97803	Strip Flex	pag. 45	9996	Strip Flex	pag. 46
9704	Strip Flex	pag. 49	97893	Strip Flex	pag. 45	9999	Strip Flex	pag. 46

## Condizioni di vendita

I colori delle fotografie degli articoli, i grafici e le quote riportati nel presente catalogo si intendono a titolo indicativo.

Athena srl si riserva la facoltà di modificare le caratteristiche tecniche ed estetiche dei prodotti senza alcun preavviso, al fini di apportare migliorie ai propri articoli. Il catalogo è tutelato dalla legge del diritto di autore e pertanto, ne è vietata la riproduzione anche parziale.

## Sales Conditions

The colours of the photographs of the articles, the graphs and the amount quoted in this catalogue are only indicative.

Athena reserves the right to make any modification to the technical and aesthetic characteristics of the products without any forewarning, in order to improve its articles.

The catalogue is protected by the law of copyright and, therefore, it is forbidden to copy it, even partially.





Via Varesina, 36 - 22078 Turate (CO)  
tel. 02 96480755 - fax 02 9681981  
info@athenainluce.it  
amministrazione@athenainluce.it  
commerciale@athenainluce.it  
**www.athenainluce.it**

